

ROOT ELEVATOR

FUNCTION OF ROOT ELEVATORS IN SURGERY

To Loosen Tooth or Root From Bony Socket Prior to Placement of The Extraction Forceps.

HANDLES FOR ROOT ELEVATORS POINTS A, B, C, D, E, F, G, H



ROOT ELEVATOR

- Элеватор корневой экстракционный
- Elévateurs à racines
- Wurzelheber
- Elevator corneviu extracționiu
- Elevadores para raices
- المصاعد الجذر

Function of Root Elevators:

To loosen tooth or root from bony socket prior to placement of the extraction forceps.

Apexo Root Elevators



Luxator Root Elevators

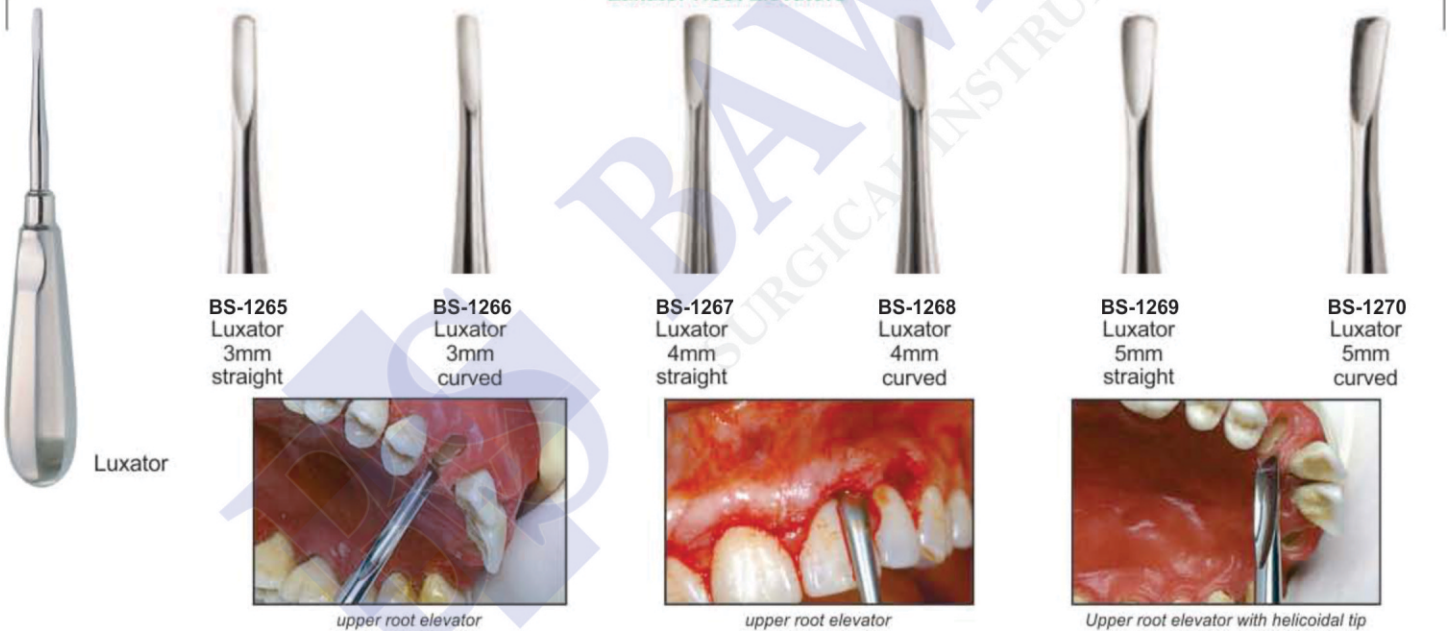

Bein Root Elevators

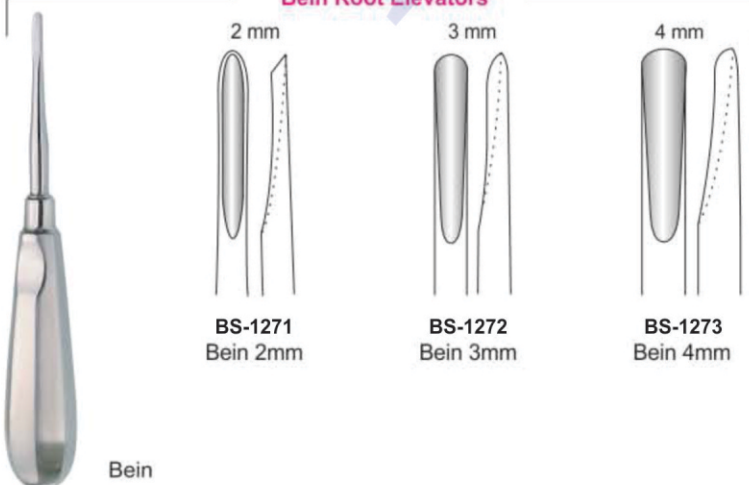

Seldin Root Elevators

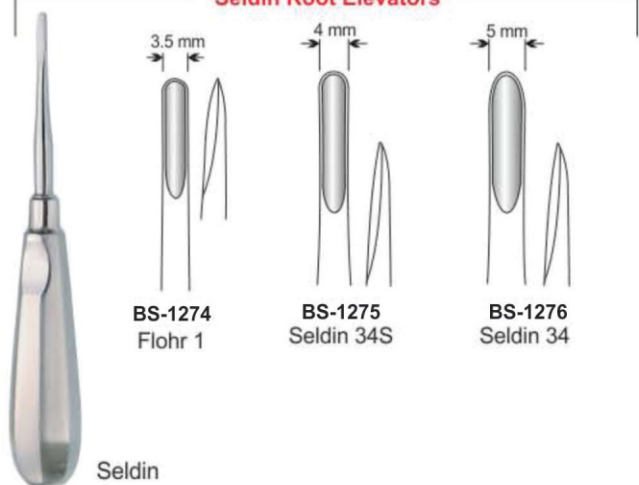

ROOT ELEVATOR

- Элеватор корневой экстракционный
- Elévateurs à racines
- Wurzelheber
- Слеватор корневий экстракційний
- Elevadores para raices
- المصاعد الجذر

FUNCTION: To loosen tooth or root from bony socket prior to placement of the extraction forceps.

Laxutor Root Elevators

Long Type



Laxutor
Root Elevator



BS-1277
Laxutor
1.5mm
Str.



BS-1278
Laxutor
2mm
Str.



BS-1279
Laxutor
3mm
Str.



BS-1280
Laxutor
5mm
Str.



BS-1281
Laxutor
3mm
Cvd.



BS-1282
Laxutor
5mm
Cvd.



BS-1283
Laxutor
3mm
Upper Angle



BS-1284
Laxutor
3mm
Double Angle



BS-1285
Laxutor
3mm
Str.



BS-1286
Laxutor
5mm
Str.



ROOT ELEVATOR

- Элеватор корневой экстракционный
- Elévateurs à racines
- Wurzelheber
- Слеватор кореневий екстракційний
- Elevadores para raices
- المصاعد الجذر

Laxutor Root Elevators

Luxator Roots Elevator

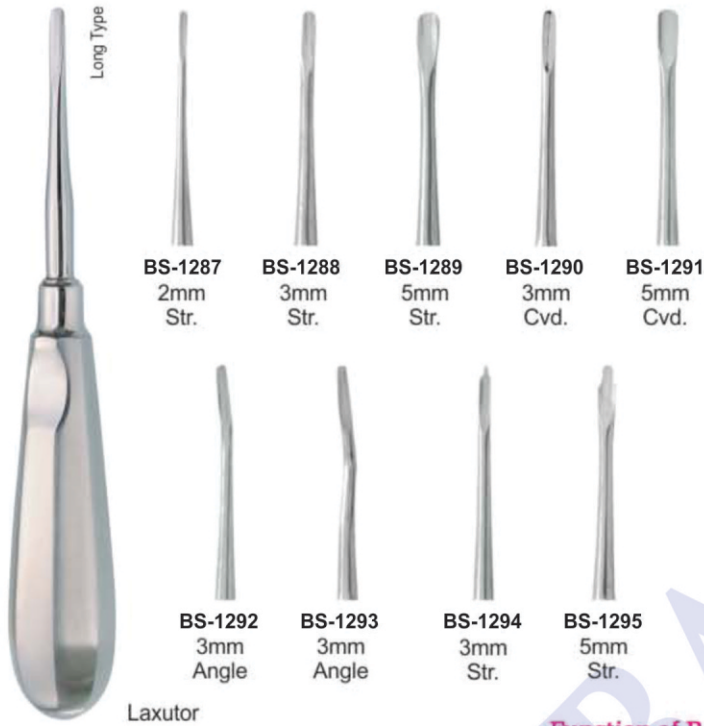

lower roots elevator



Upper root elevator with helicoidal tip



BS-1296
Luxator
Straight

BS-1297
Luxator
Curved

Function of Root Elevators:

To loosen tooth or root from bony socket prior to placement of the extraction forceps.

Apical Root Elevators

Apical Root Elevators

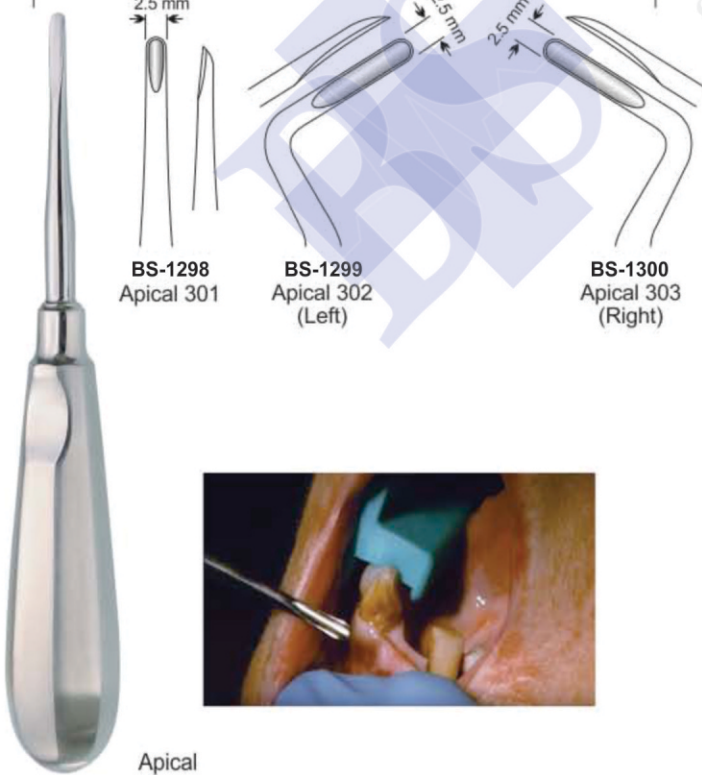

Apical

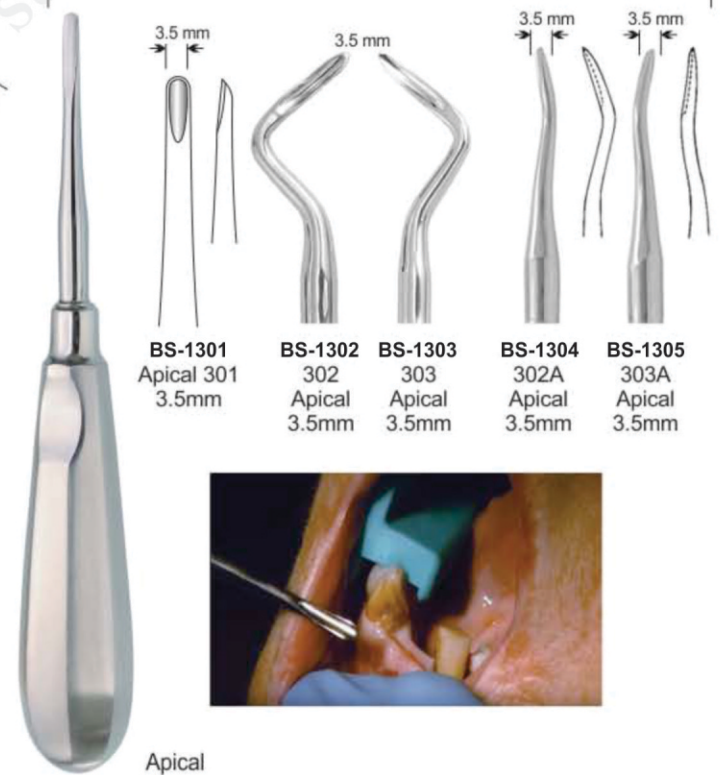

Apical



ROOT ELEVATOR

- Элеватор корневой экстракционный
- Elévateurs à racines
- Wurzelheber
- Слеватор корневий экстракційний
- Elevadores para raices
- المصاعد الجذر

FUNCTION: To Loosen Tooth or Root From Bony Socket Prior to Placement of The Extraction Forceps.

Cryer Root Elevators

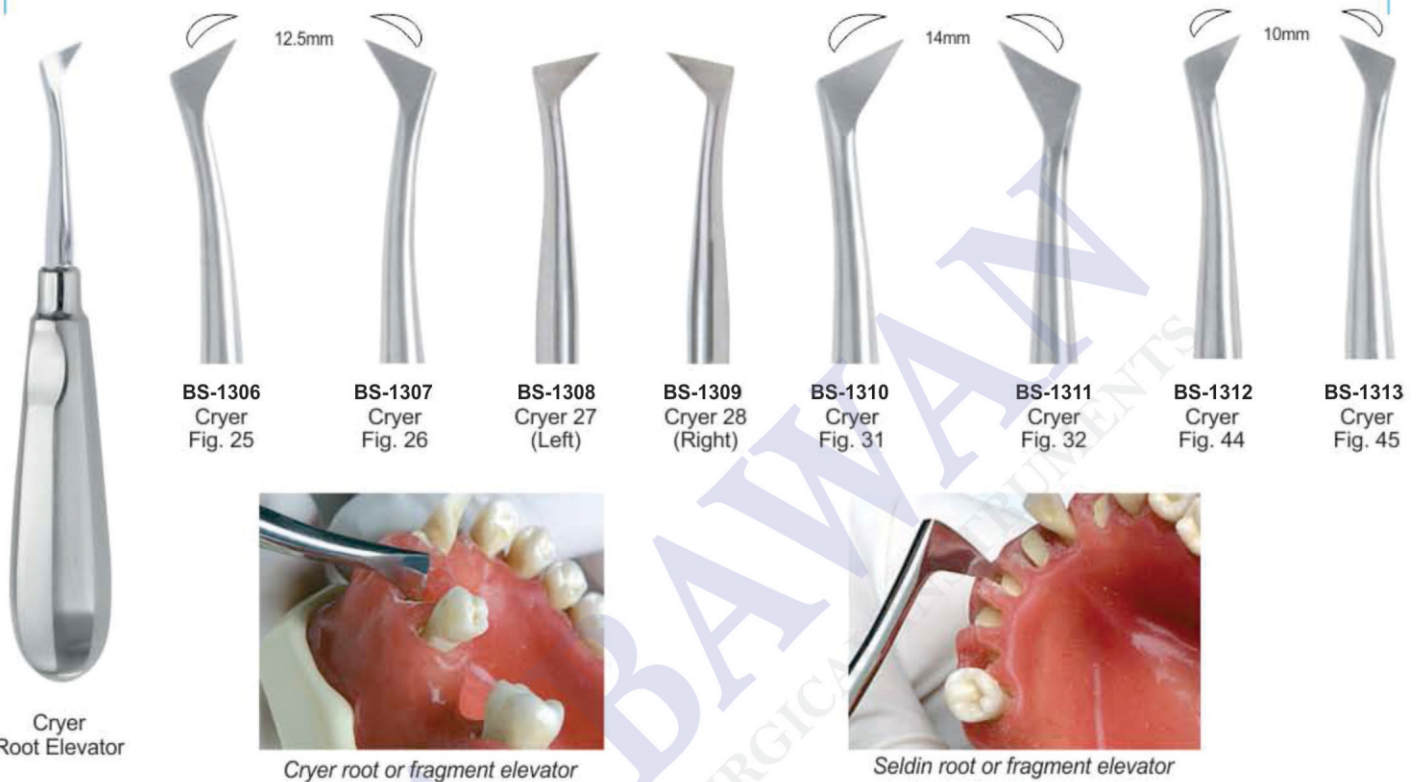

Seldin Root Elevators

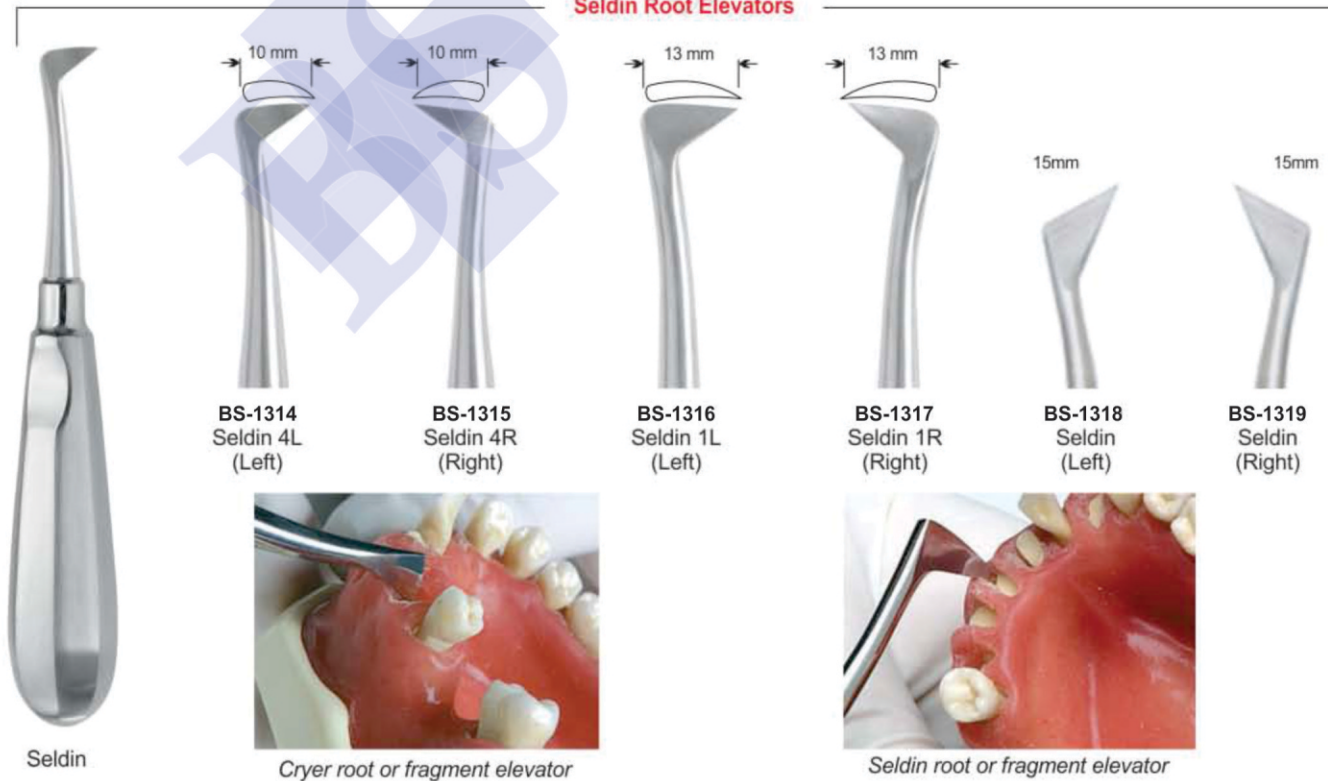

ROOT ELEVATOR

- Элеватор корневой экстракционный
- Elévateurs à racines
- Wurzelheber
- Слеватор кореневий экстракційний
- Elevadores para raices
- المصاعد الجذر

FUNCTION: To Loosen Tooth or Root From Bony Socket Prior to Placement of The Extraction Forceps.

Apical Root Elevators

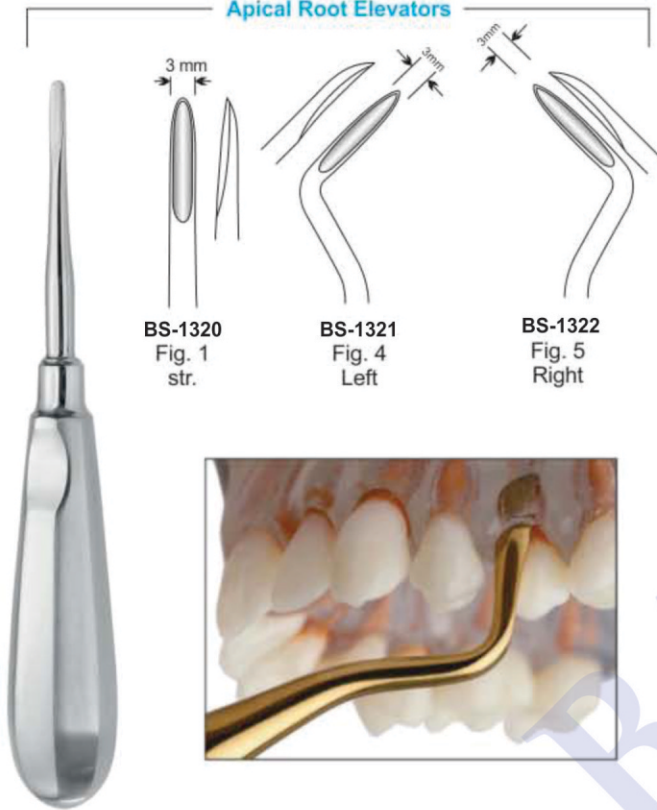

Apical Root Elevators

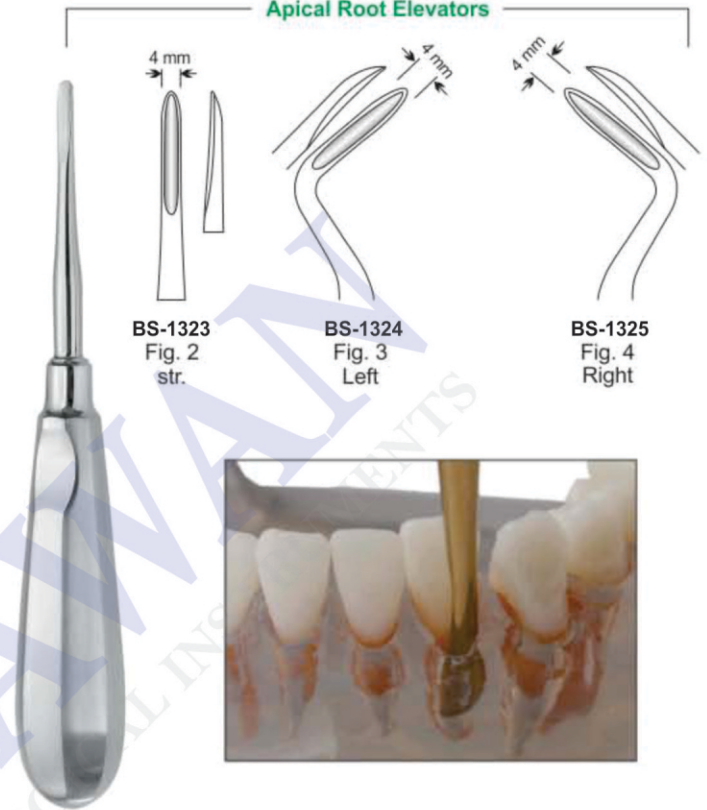

Flohr Root Elevators



Heidbrink Root Elevators

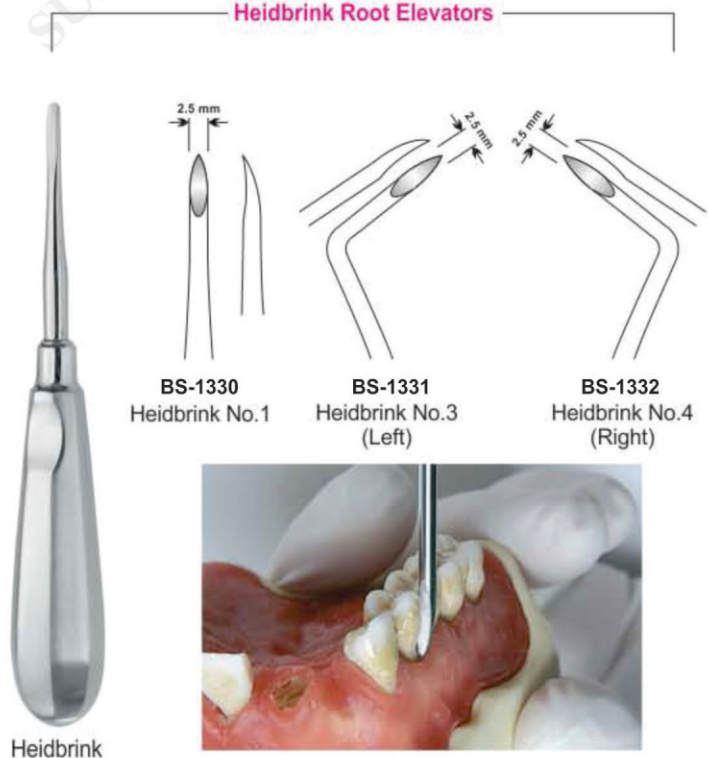

ROOT ELEVATOR

- Элеватор корневой экстракционный
- Elévateurs à racines
- Wurzelheber
- Слеватор корневий экстракційний
- Elevadores para raices
- المصاعد الجذر

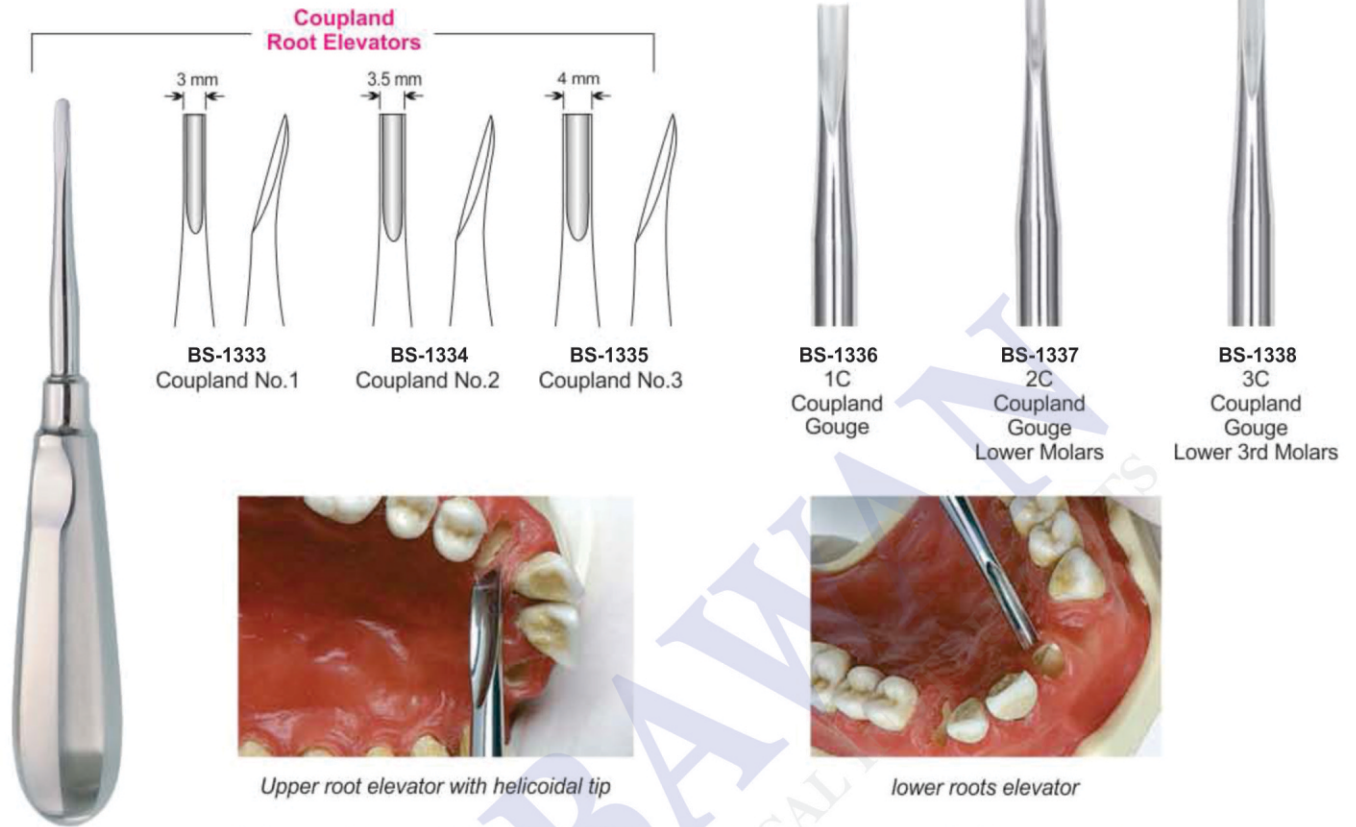

FUNCTION: To Loosen Tooth or Root From Bony Socket Prior to Placement of The Extraction Forceps.

ENGLISH PATTERNS

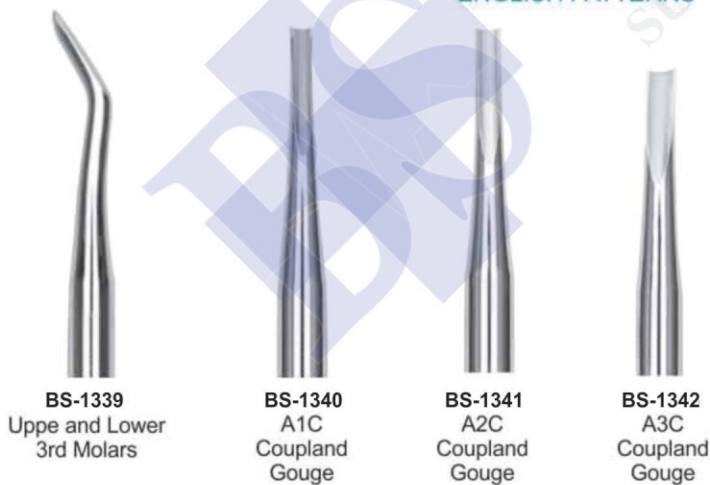

ROOT ELEVATOR

- Элеватор корневой экстракционный
- Elévateurs à racines
- Wurzelheber
- Слеватор корневий екстракційний
- Elevadores para raices
- المصاعد الجذر

Lindo Levian Root Elevators

Function of Root Elevators:
To loosen tooth or root from bony socket prior to placement of the extraction forceps.

BS-1346 25 LINDO LEVIAN 2.5x5mm straight

BS-1347 35 LINDO LEVIAN 3x8mm straight

BS-1348 45 LINDO LEVIAN 4x8mm straight

BS-1349 1 LINDO LEVIAN 2.5x5 curved

BS-1350 2 LINDO LEVIAN 3x8 curved

BS-1351 3 LINDO LEVIAN 4x8 curved

BS-1352 Lindo-Levian Serrated Curved

BS-1353 Lindo-Levian Serrated Right

Bein BS-1354

Bein BS-1355

Bein BS-1356

Bein BS-1357

Gartner BS-1358

Gartner BS-1359

Gartner BS-1360

ROOT ELEVATOR

- Элеватор корневой экстракционный
- Elévateurs à racines
- Wurzelheber
- Слеватор корневий экстракційний
- Elevadores para raices
- المصاعد الجذر

Friedmann Roots Elevator



Hi1361
Friedmann 4F
Str.

BS-1362
Friedmann 5F
Left

Hi1363
Friedmann 6F
Right

Luxating Elevator With Periotome Tip

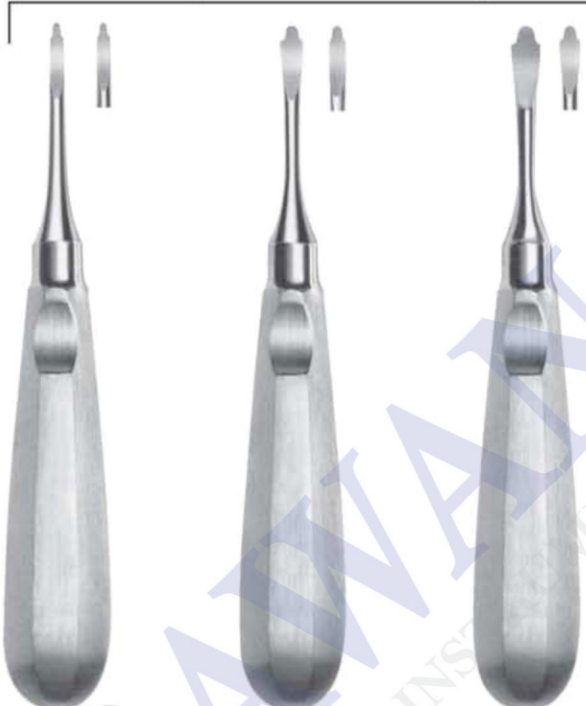

BS-1364
3mm Luxating
Elevator / Periotome

BS-1365
4mm Luxating
Elevator / Periotome

BS-1366
5mm Luxating
Elevator / Periotome

Wisdom Roots Elevator



BS-1367
Wisdom
for 18 and 38

BS-1368
Wisdom
for 28 and 48

Function of Root Elevators: To loosen tooth or root from bony socket prior to placement of the extraction forceps.

Bayonet Roots Elevator Set



BS-1369
Left

BS-1370
Right

BS-1371
bayonet

BS-1372
Curved

BS-1373
Straight

ROOT ELEVATOR

- Элеватор корневой экстракционный
- Elévateurs à racines
- Wurzelheber
- Слеватор корневий екстракційний
- Elevadores para raices
- المصاعد الجذر

Miller Root Elevators

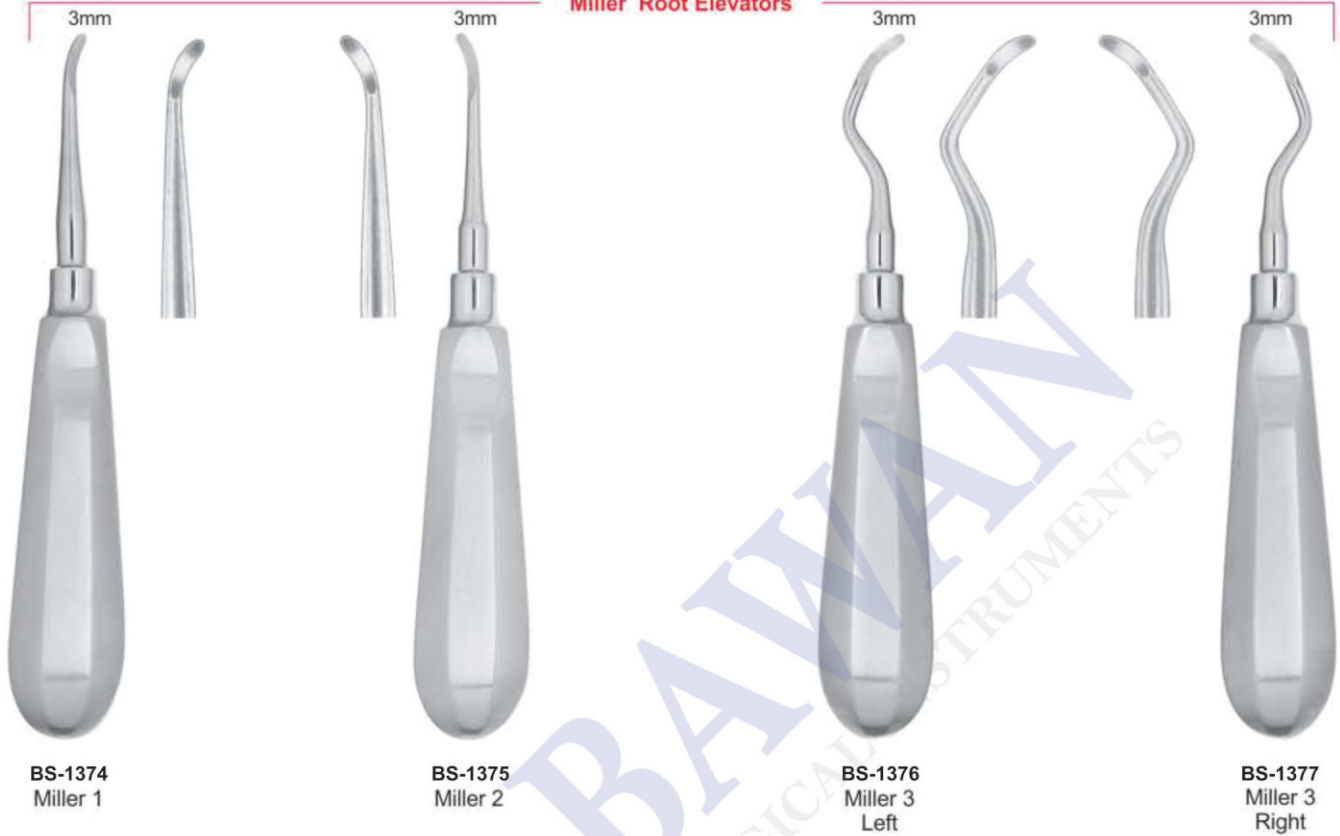

Function of Root Elevators: To loosen tooth or root from bony socket prior to placement of the extraction forceps.

Claw-Lift Roots Elevator

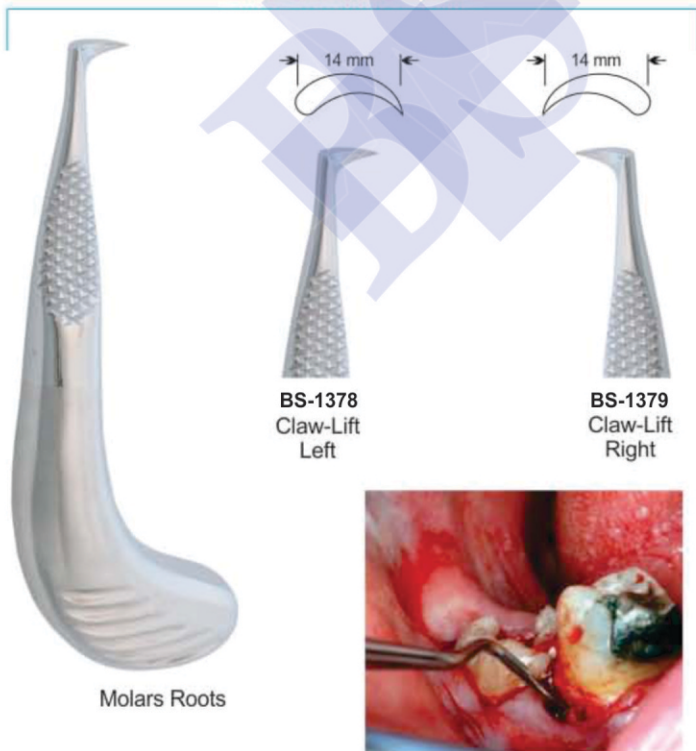

Schlemmer Roots Elevator



ROOT ELEVATOR

- Элеватор корневой экстракционный
- Elévateurs à racines
- Wurzelheber
- Слеватор корневий екстракційний
- Elevadores para raices
- المصاعد الجذر

FUNCTION: To Loosen Tooth or Root From Bony Socket Prior to Placement of The Extraction Forceps.

Laxutor Root Elevators Set of 9 Pcs



BS-1383
2mm Str.



BS-1384
3mm Str.



BS-1385
5mm Str.



BS-1386
3mm Cvd.



BS-1387
5mm Cvd.



BS-1388
3mm Angle



BS-1389
3mm Angle



BS-1390
3mm Str.



BS-1391
5mm Str.

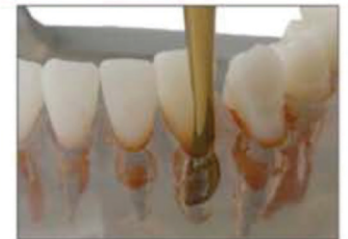

ROOT ELEVATOR

- Элеватор корневой экстракционный
- Elévateurs à racines
- Wurzelheber
- Слеватор кореневий екстракційний
- Elevadores para raices
- المصاعد الجذر

Hylin Roots Elevator



Function of Root Elevators: To loosen tooth or root from bony socket prior to placement of the extraction forceps.

Kopp Roots Elevator

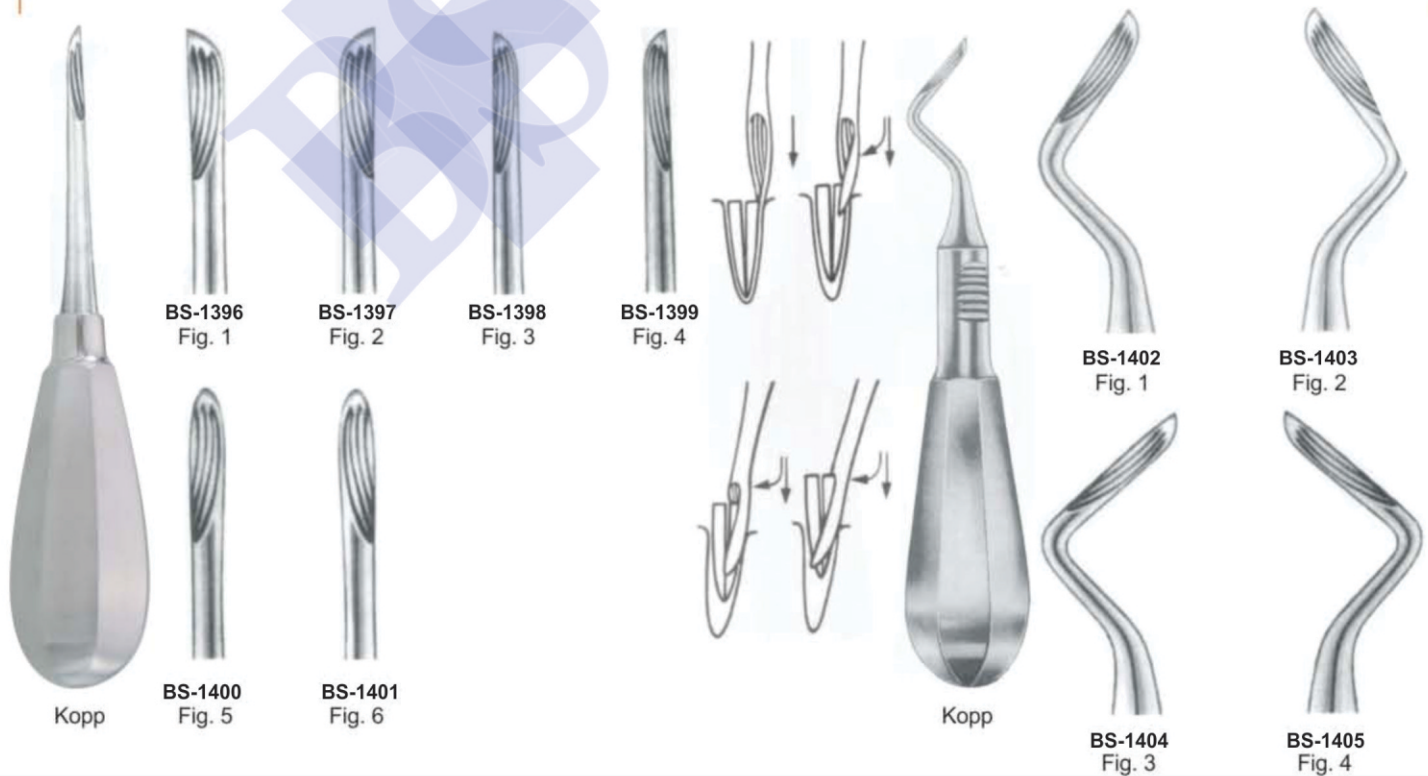

ROOT ELEVATOR

- Элеватор корневой экстракционный
- Elévateurs à racines
- Wurzelheber
- Слеватор корневий экстракційний
- Elevadores para raices
- المصاعد الجذر

Luxier Roots Elevator



BS-1406
Luxier
Cvd.

BS-1407
Luxier
Str.

Heber Roots Elevator



BS-1408
Heber
Bayonet

BS-1409
Heber
Bayonet

Bein Roots Elevator



BS-1410
Bein,
3mm

BS-1411
Bein,
4mm

Function of Root Elevators: To loosen tooth or root from bony socket prior to placement of the extraction forceps.

Bein Roots Elevator

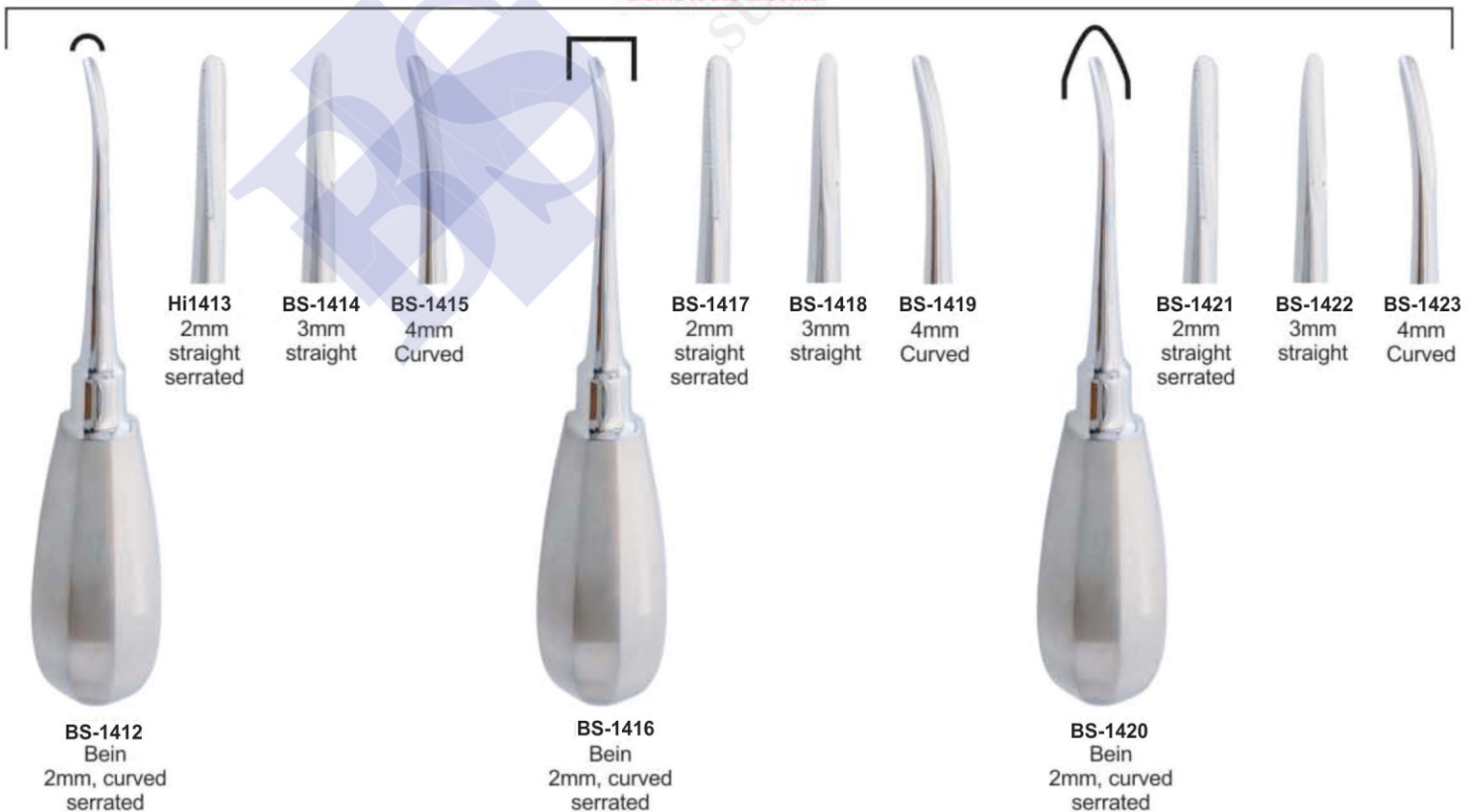

ROOT ELEVATOR

- Элеватор корневой экстракционный
- Elévateurs à racines
- Wurzelheber
- Слеватор корневий экстракційний
- Elevadores para raices
- المصاعد الجذر

W. Barry Roots Elevator



W. Barry
Fig. 1
(125mm)

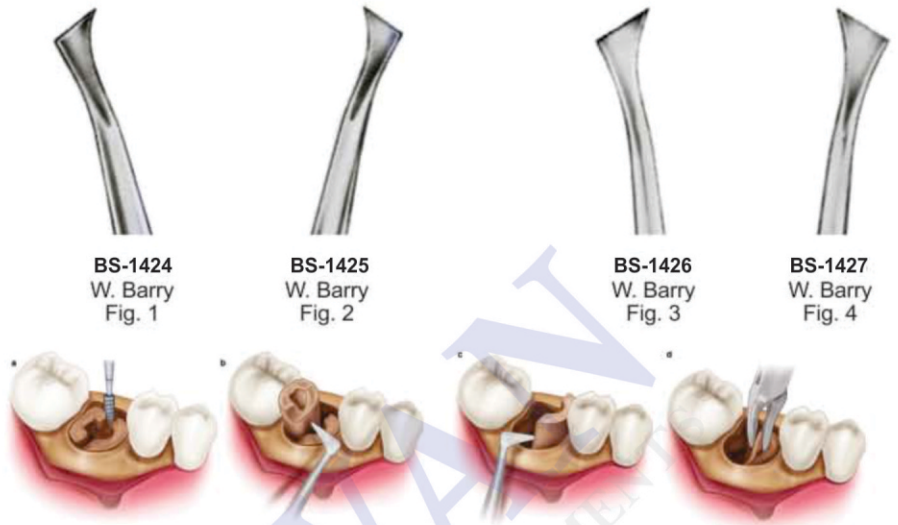

BS-1424
W. Barry
Fig. 1

BS-1425
W. Barry
Fig. 2

BS-1426
W. Barry
Fig. 3

BS-1427
W. Barry
Fig. 4

Function of Root Elevators: To loosen tooth or root from bony socket prior to placement of the extraction forceps.



BS-1428
Winter
Fig. 1L

BS-1429
Winter
Fig. 1R

BS-1430
775/3
Winter
11 L

BS-1431
775/4
Winter
11 R

BS-1432
775/5
Winter
12 L

BS-1433
775/6
Winter
12 R

BS-1434
775/7
Winter
13 L

BS-1435
775/8
Winter
13 R

Winter
Fig. 1L
125mm

BS-1436
Winter
Fig. 1L

BS-1437
Winter
Fig. 1R

BS-1438
Lecluse
bayonet

BS-1439
Potts "T-Handle"
Elevator-Left

BS-1440
Potts "T-Handle"
Elevator-Right

ROOT ELEVATOR

- Элеватор корневой экстракционный
- Elévateurs à racines
- Wurzelheber
- Слеватор корневий екстракційний
- Elevadores para raices
- المصاعد الجذر



BS-1441
Fig. 1
Chompret



BS-1442
Fig. 2
Chompret



BS-1443
Fig. 3
Chompret



BS-1444
Fig. 4
Chompret



Lecluse elevator for lower third molar dislocation



Chompret syndesmotome, sickle pattern

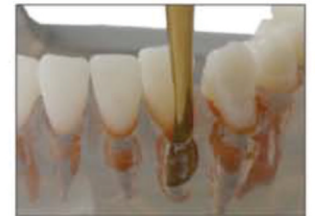
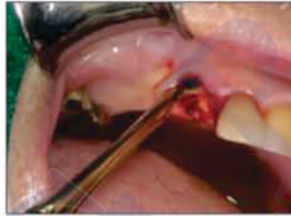

BS-1445



BS-1446



BS-1447



BS-1448



BS-1449



BS-1450



BS-1451

Root Pick Elevator With Gold Flexible Points

ROOT ELEVATOR

- Элеватор корневой экстракционный
- Elévateurs à racines
- Wurzelheber
- Слеватор корневий екстракційний
- Elevadores para raices
- المصاعد الجذر

Heidbrink Roots Elevator



BS-1452
Heidbrink
Straight

BS-1453
Heidbrink
Left

BS-1454
Heidbrink
Right

BS-1455
Heidbrink
Straight

BS-1456
Heidbrink
Left

BS-1457
Heidbrink
Right

Syndesmotomes Roots Elevator



BS-1458
Straight

BS-1459
Left

BS-1460
Right

Periotome Roots Elevator



BS-1461
Periotome
2.1mm
Straight

BS-1462
Periotome
2.6mm
Straight

BS-1463
Periotome
2.1mm
Angular

BS-1464
Periotome
2mm
Curved

BS-1465
Periotome
2.0mm

BS-1466
Periotome
2.5mm

BS-1467
Periotome
3.0mm

BS-1468
Periotome
4.0mm

Syndesmotomes

ROOT ELEVATOR

- Элеватор корневой экстракционный
- Elévateurs à racines
- Wurzelheber
- Слеватор кореневий екстракційний
- Elevadores para raices
- المصاعد الجذر

FUNCTION: To loosen small root fragments from bony socket

Heidbrink Roots Elevator

Warwick-James

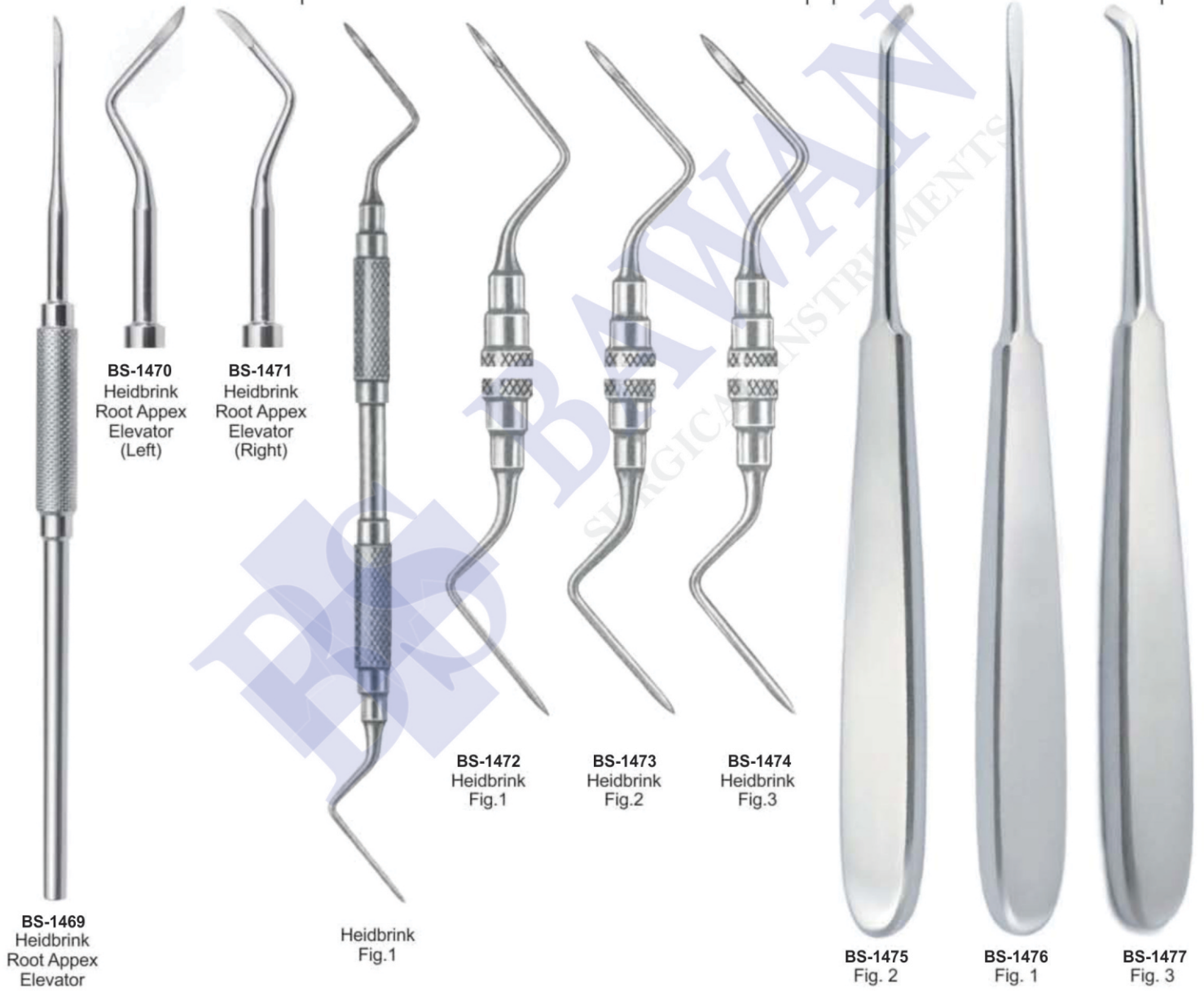

ROOT ELEVATOR

- Элеватор корневой экстракционный
- Elévateurs à racines
- Wurzelheber
- Слеватор кореневий екстракційний
- Elevadores para raices
- المصاعد الجذر



BS-1478
1S
(Straight 1mm)



BS-1479
2S
(Straight 2mm)



BS-1480
3S
(Straight 3mm)



BS-1481
5S
(Straight 5mm)



BS-1482
3C
(Curved 3mm)



BS-1483
5C
(Curved 5mm)



BS-1484
3CA
(Curved Angle 3mm)



BS-1485
3IC
(Inverted Curved 3mm)



BS-1486
DE 3
(Dual Edge 3mm / 1.5mm)



BS-1487
DE 5
(Dual Edge 5mm / 3mm)

ROOT ELEVATOR

- Элеватор корневой экстракционный
- Elévateurs à racines
- Wurzelheber
- Слеватор корневий екстракційний
- Elevadores para raices
- المصاعد الجذر



BS-1488
 Luxators Set of 7 Pcs

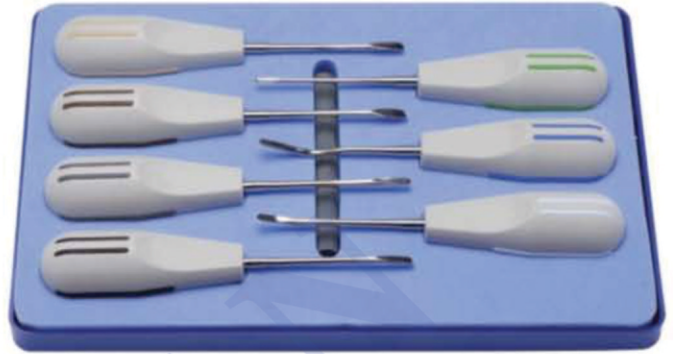

BS-1489
 Luxators Set of 7 Pcs



BS-1490
 Luxators Set of 8 Pcs



BS-1491
 Root Elevators Set of 10 Pcs



BS-1492
 Elevators Set of 8 Pcs



BS-1493
 Elevators Set of 8 Pcs

ROOT ELEVATOR

- Элеватор корневой экстракционный
 - Elévateurs à racines
 - Wurzelheber
- Слеватор корневий екстракційний
 - Elevadores para raices
 - المصاعد الجذر

PDL ELEVATORS

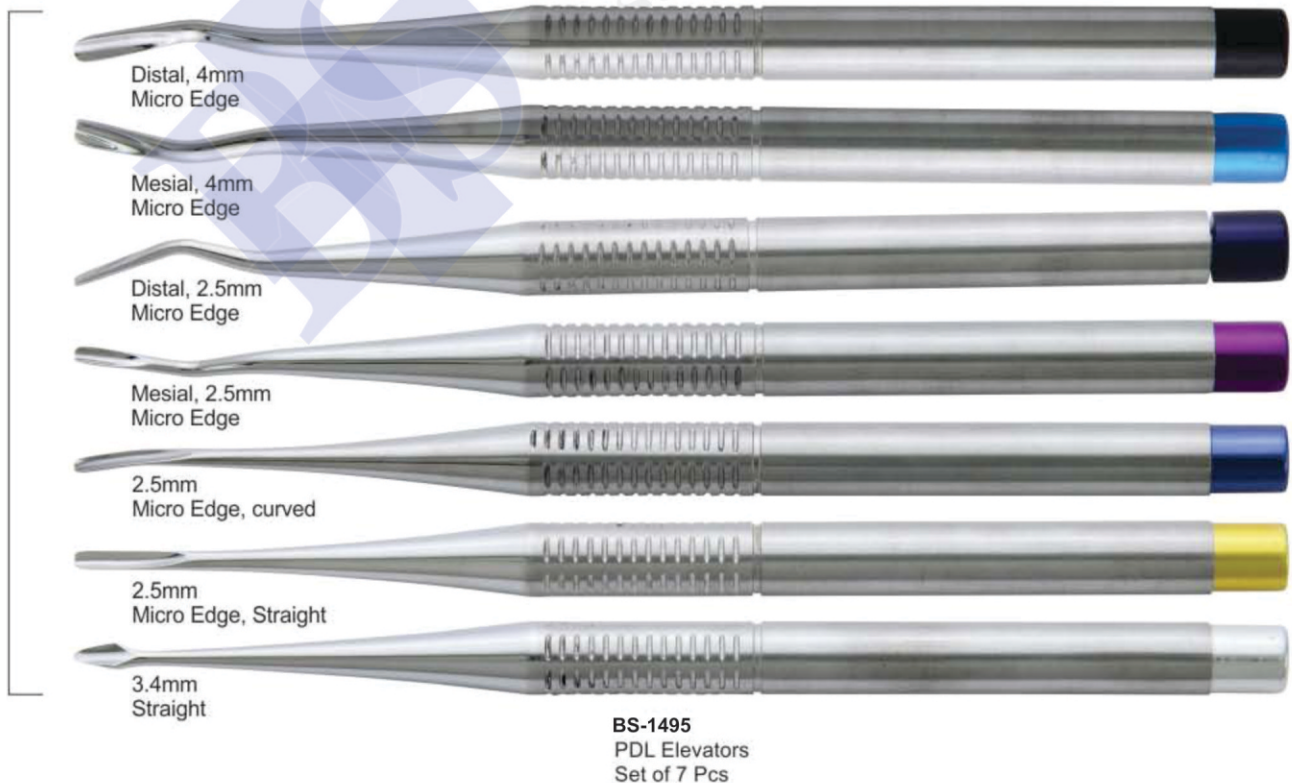

ROOT ELEVATOR

- Элеватор корневой экстракционный
- Elévateurs à racines
- Wurzelheber
- Слеватор кореневий екстракційний
- Elevadores para raices
- المصاعد الجذر

PDL ELEVATORS

Delicate Arrow tip



4,0mm straight
4,0mm curved

Luxivators straight
atraumatic luxation of the tooth



2,5mm straight
3,5mm straight
4,5mm straight

Luxivators curved
atraumatic luxation of the tooth



2,5mm curved
3,5mm curved
4,5mm curved



BS-1496
PDL Elevators
Set of 8 Pcs