



Scissors





Standard
Fig. 1-3
curved

cm	in.	Fig. 1	Fig. 2	Fig. 3
11.5	4 1/2	BS03-001-11	BS03-003-11	BS03-005-11
13.0	5	BS03-001-13	BS03-003-13	BS03-005-13
14.5	5 1/2	BS03-001-14	BS03-003-14	BS03-005-14
15.5	6	BS03-001-15	BS03-003-15	BS03-005-15
16.5	6 1/2	BS03-001-16	BS03-003-16	BS03-005-16
18.5	7 1/4	BS03-001-18	BS03-003-18	
20.0	8	BS03-001-20	BS03-003-20	

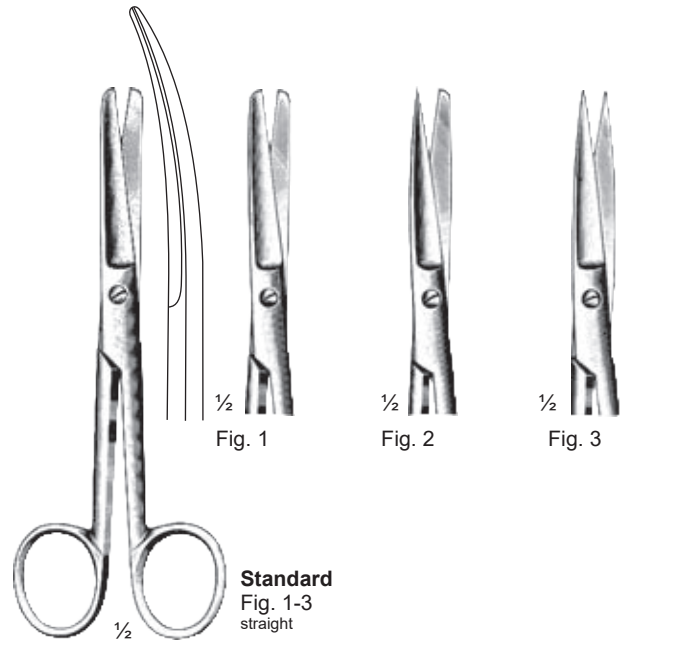

Standard
Fig. 1-3
straight

cm	in.	Fig. 1	Fig. 2	Fig. 3
10.5	4 1/4	BS03-007-10	BS03-009-10	BS03-011-10
11.5	4 1/2	BS03-007-11	BS03-009-11	BS03-011-11
13.0	5	BS03-007-13	BS03-009-13	BS03-011-13
14.5	5 1/2	BS03-007-14	BS03-009-14	BS03-011-14
15.5	6	BS03-007-15	BS03-009-15	BS03-011-15
16.5	6 1/2	BS03-007-16	BS03-009-16	BS03-011-16
18.5	7 1/4	BS03-007-18	BS03-009-18	
20.0	8	BS03-007-20	BS03-009-20	

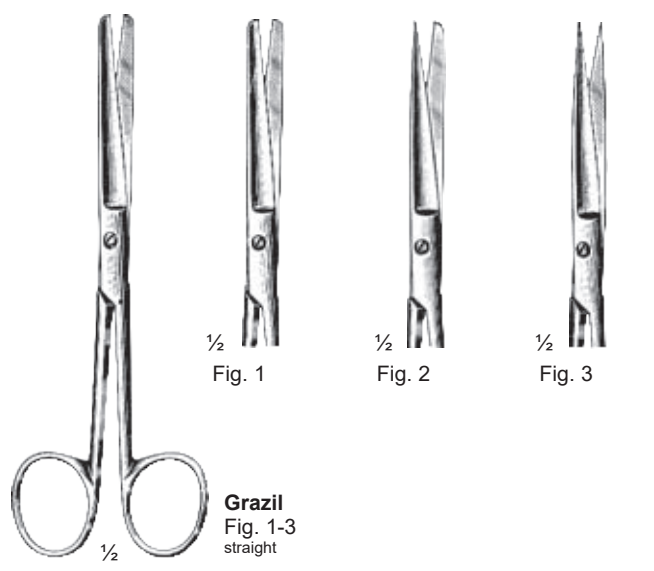

Grazil
Fig. 1-3
straight

cm	in.	Fig. 1	Fig. 2	Fig. 3
13.0	5		BS03-015-13	
14.5	5 1/2	BS03-013-14	BS03-015-14	BS03-017-14

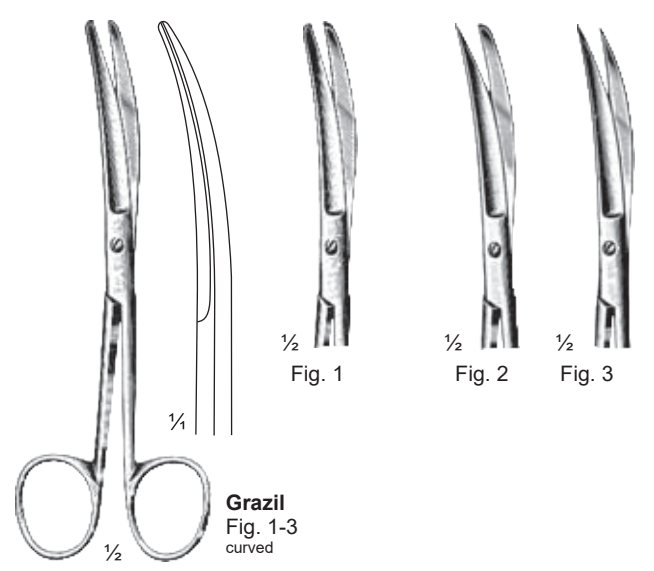

Grazil
Fig. 1-3
curved

cm	in.	Fig. 1	Fig. 2	Fig. 3
13.0	5		BS03-021-13	
14.5	5 1/2	BS03-019-14	BS03-021-14	BS03-023-14

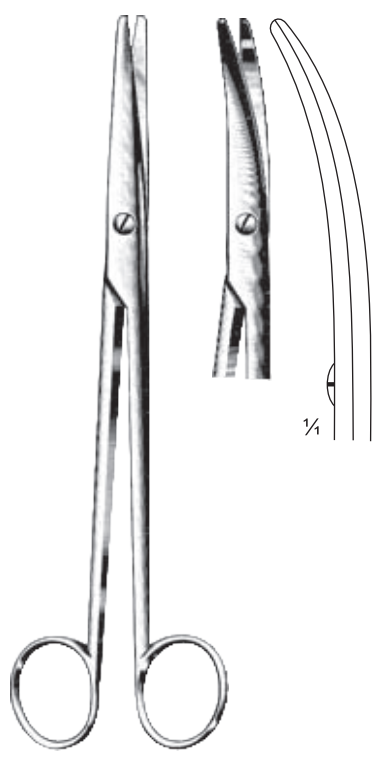

Mayo-Stille

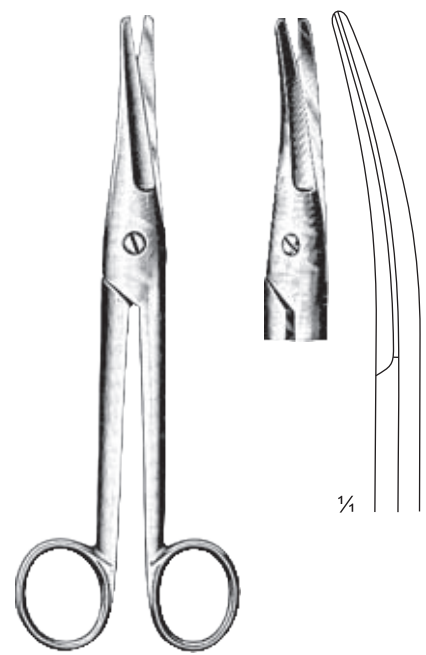

Mayo-Noble

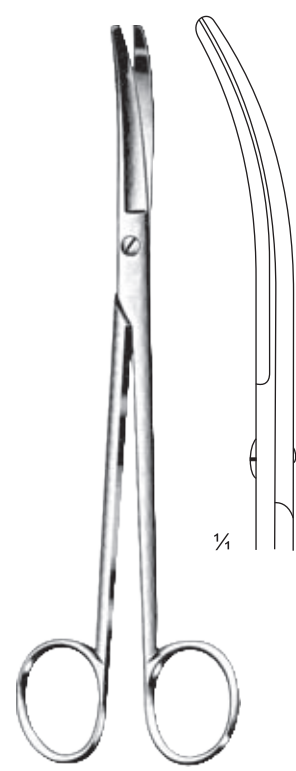

Wertheim

cm	in.	straight	curved	straight	curved	curved
14.5	5 ½					BS03-033-14
16.5	6 ½	BS03-025-16	BS03-027-16			
17.0	6 ¾			BS03-029-17	BS03-031-17	
19.5	7 ¾	BS03-025-19	BS03-027-19			BS03-033-19
21.0	8 ¼	BS03-025-21	BS03-027-21			
22.5	9					BS03-033-22



BS03-035-13 = 13 cm/5"
BS03-035-14 = 14.5 cm/5 ½"

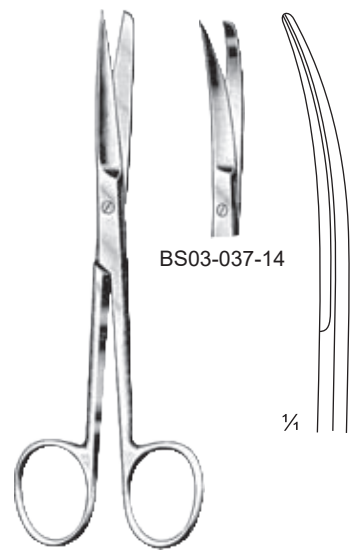

Deaver
BS03-036-14
14 cm/5 ½"

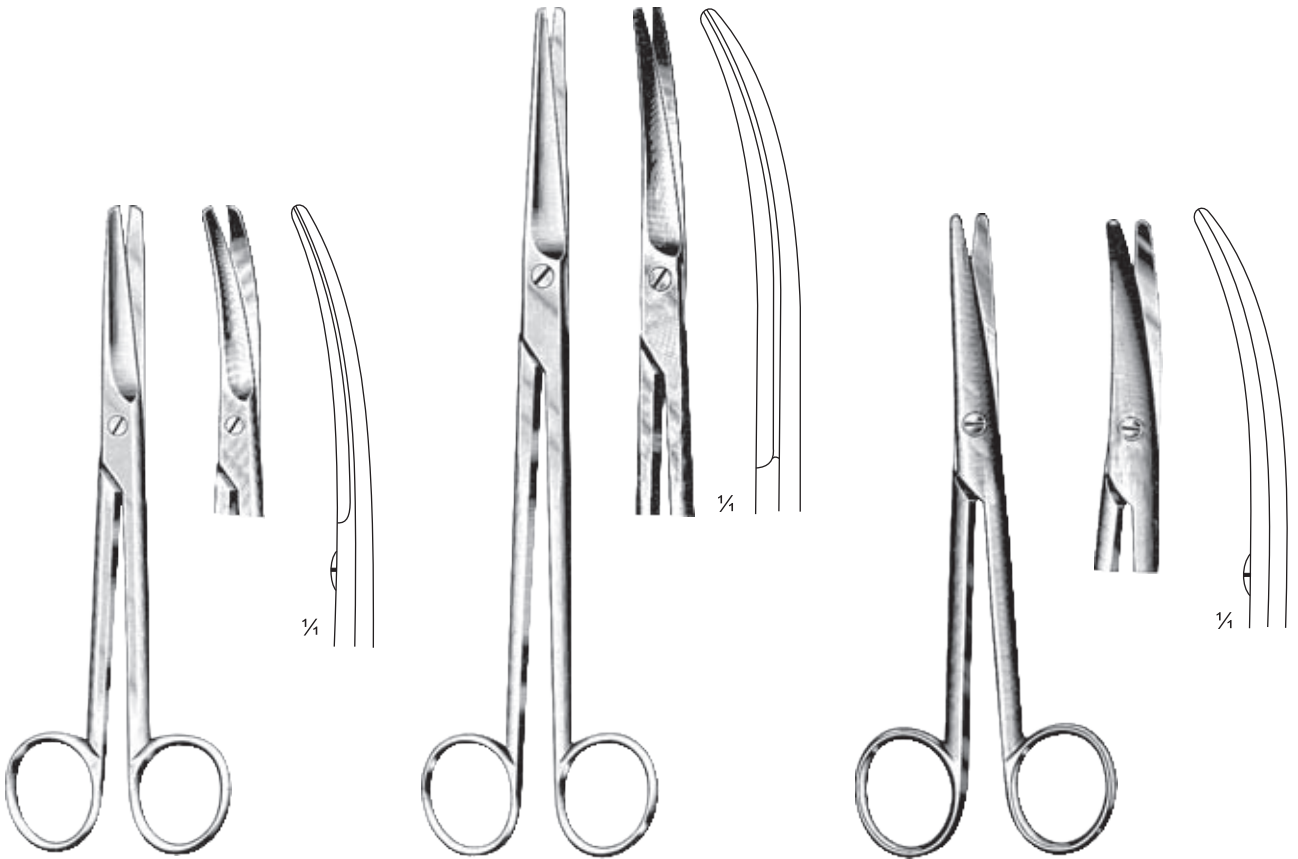

Mayo

Mayo-Harrington

Mayo-Stille

cm	in.	straight	curved	straight	curved	straight	curved
14.5	5 ½	BS03-039-14	BS03-041-14				
15.0	6	BS03-039-15	BS03-041-15			BS03-047-15	BS03-049-15
17.0	6 ¾	BS03-039-17	BS03-041-17			BS03-047-17	BS03-049-17
22.5	9			BS03-043-22	BS03-045-22		
23.0	9	BS03-039-23	BS03-041-23				
30.0	12				BS03-045-30		

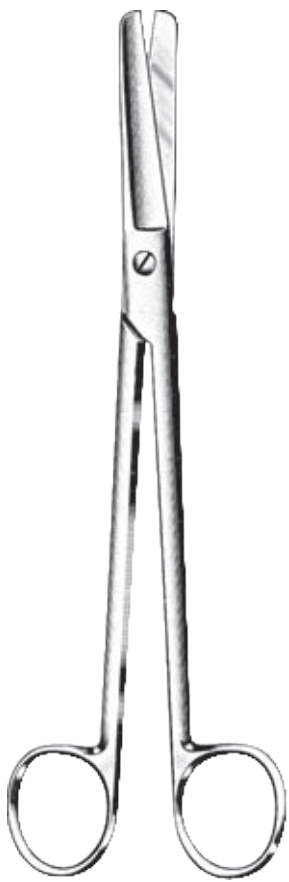

Sims
BS03-051-20 = 20cm/8"
BS03-051-23 = 23cm/9"
straight

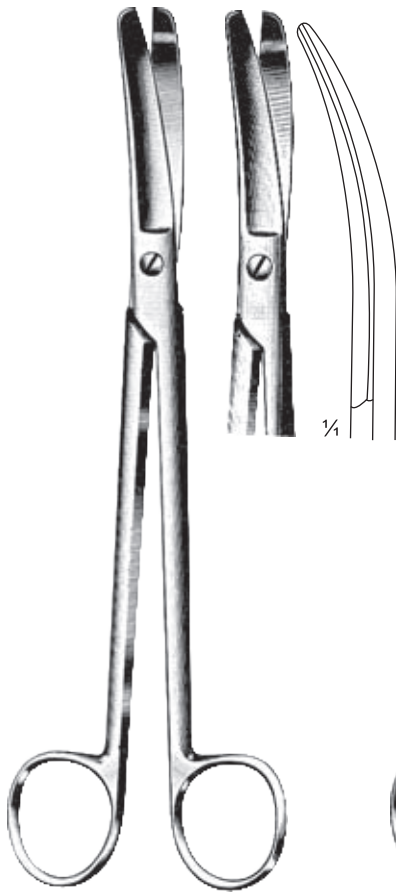

Sims
BS03-053-20 = 20cm/8"
BS03-053-23 = 23cm/9"
curved

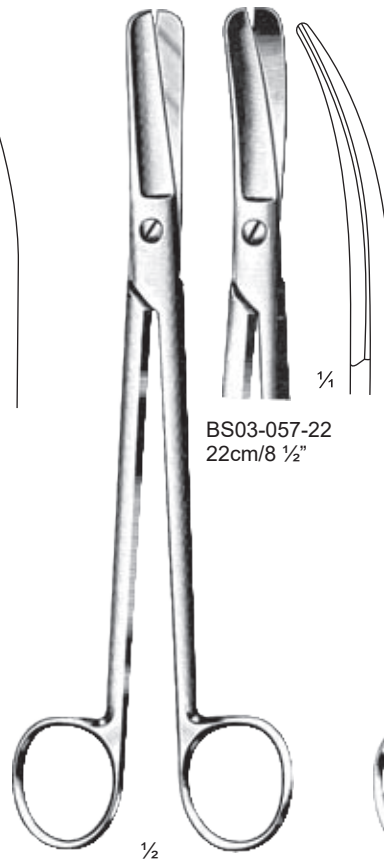

Sims-Martin
BS03-055-22
22cm/8 1/2"

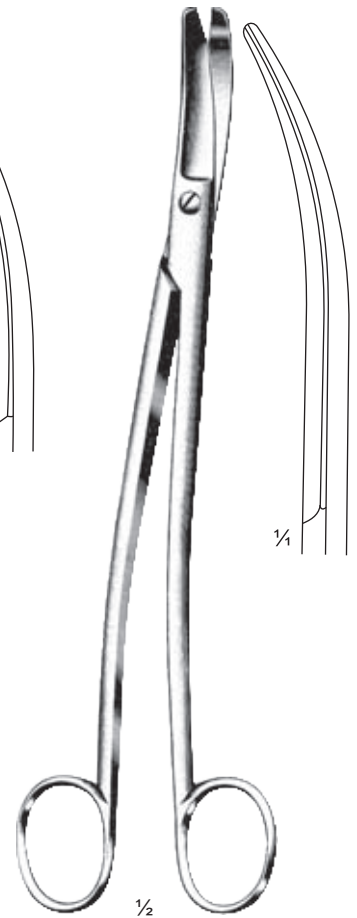

Siebold
BS03-059-24
24cm/9 1/2"
S-curved

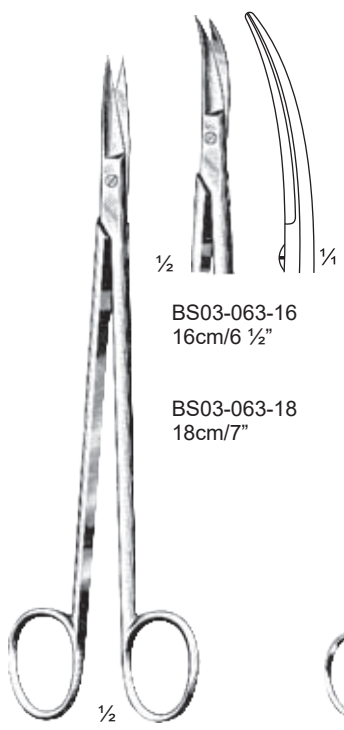

BS03-063-16
16cm/6 1/2"

BS03-063-18
18cm/7"

Kelly
BS03-061-16 = 16 cm/6 1/2"
BS03-061-18 = 18 cm/7"

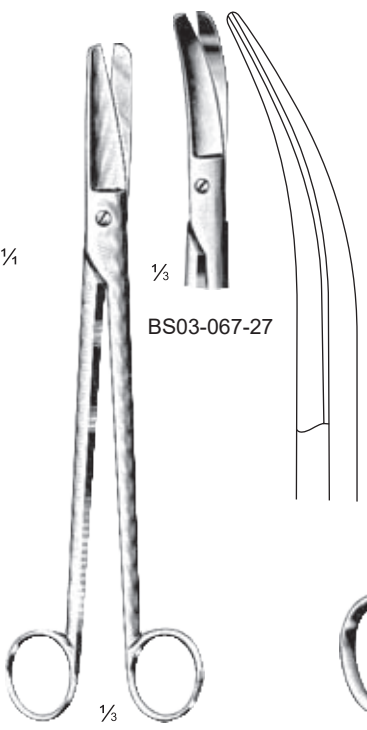

BS03-067-27

Dubois
BS03-065-27
27 cm/10 1/2"

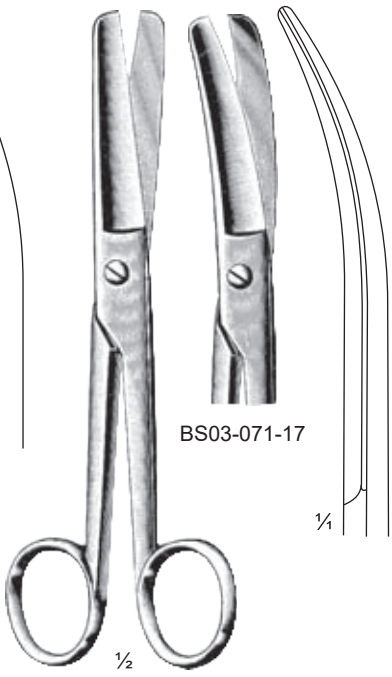

BS03-071-17

Doyen
BS03-069-17
17.5 cm/7"

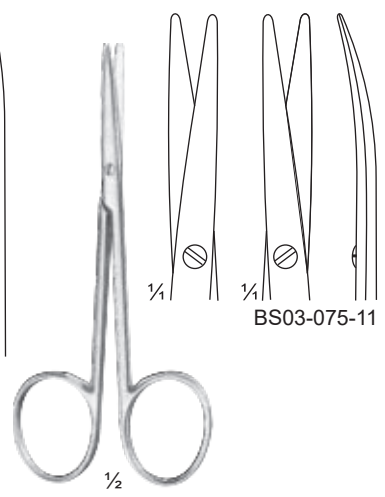

BS03-075-11

BS03-073-11
11.5 cm/4 1/2"

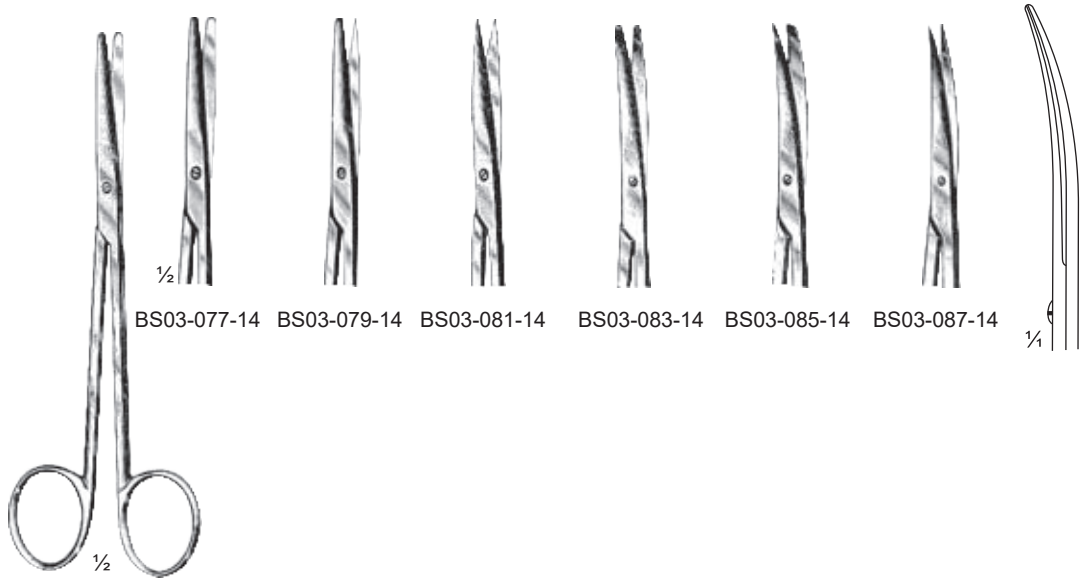

BS03-077-14 BS03-079-14 BS03-081-14 BS03-083-14 BS03-085-14 BS03-087-14

Metzenbaum
14.5 cm/5 1/2"

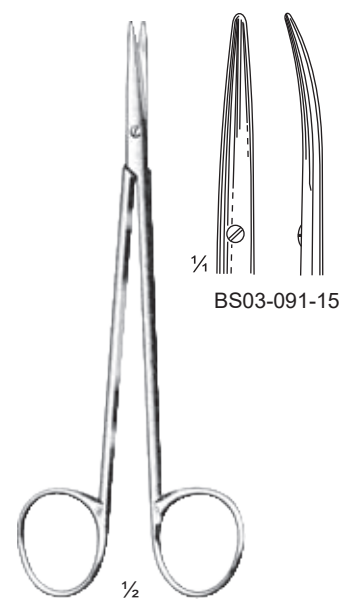

BS03-091-15

Metzenbaum
BS03-089-15
15 cm/6"



Metzenbaum-Nelson



Fig. 1



Fig. 2



Fig. 3



Fig. 4



Fig. 5

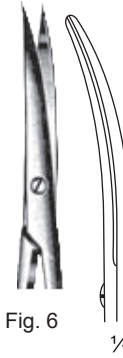
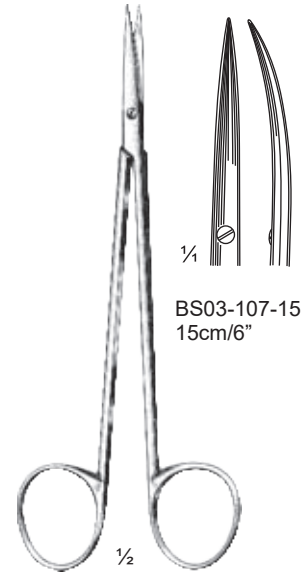

Fig. 6



BS03-107-15
15cm/6"

Nerv-Prapariererschere

BS03-105-15
15 cm/6"

Nerve dissecting scissors

cm	in.	Fig. 1	Fig. 2	Fig. 3	Fig. 4	Fig. 5	Fig. 6
18.0	07	BS03-093-18	BS03-095-18	BS03-097-18	BS03-099-18	BS03-101-18	BS03-103-18
20.0	08	BS03-093-20	BS03-095-20	BS03-097-20	BS03-099-20	BS03-101-20	BS03-103-20
23.0	09	BS03-093-23	BS03-095-23	BS03-097-23	BS03-099-23	BS03-101-23	BS03-103-23
25.0	10	BS03-093-25	BS03-095-25	BS03-097-25	BS03-099-25	BS03-101-25	BS03-103-25
28.0	11	BS03-093-28	BS03-095-28	BS03-097-28	BS03-099-28	BS03-101-28	BS03-103-28
30.0	12	BS03-093-30	BS03-095-30	BS03-097-30	BS03-099-30	BS03-101-30	BS03-103-30

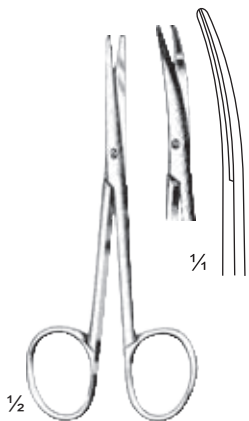

Lexer-Baby
BS03-109-10
10 cm/4"

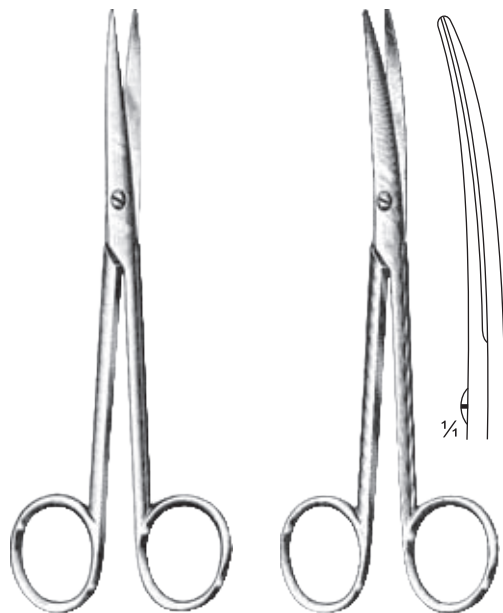

Lexer
BS03-111-16 = 16 cm/6 1/4"
BS03-111-21 = 21 cm/8 1/2"

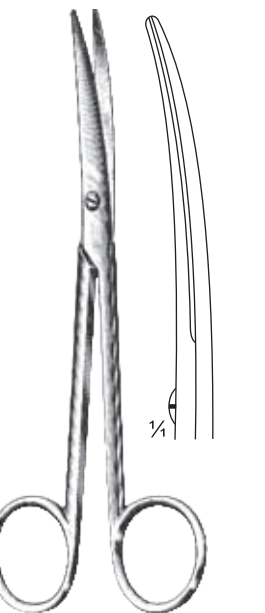

Lexer
BS03-113-16 = 16 cm/6 1/4"
BS03-113-21 = 21 cm/8 1/2"

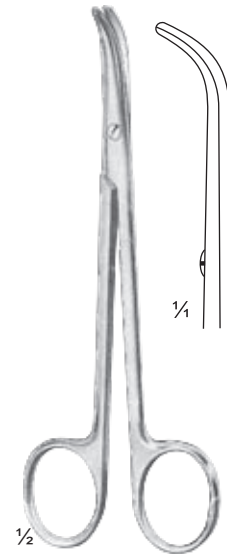

Fomon
BS03-115-14
13.5 cm/5 1/4"

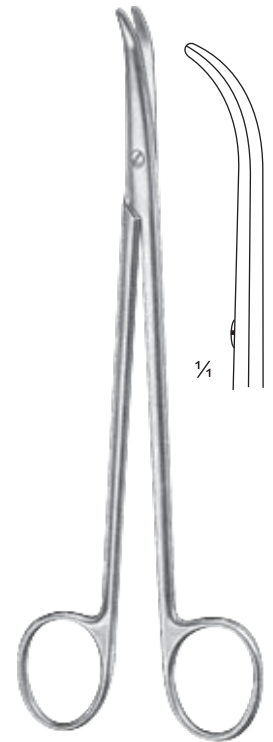

Thorek
BS03-117-19
19 cm/7 1/2"

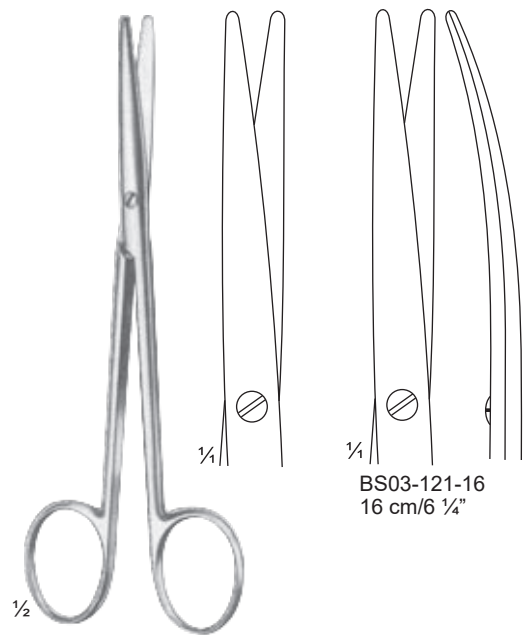

Lexer-Fino
BS03-119-16
16 cm/6 1/4"

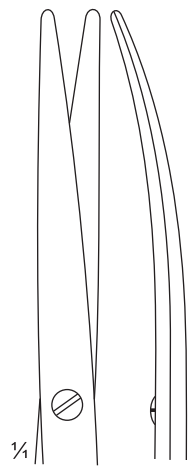

BS03-121-16
16 cm/6 1/4"

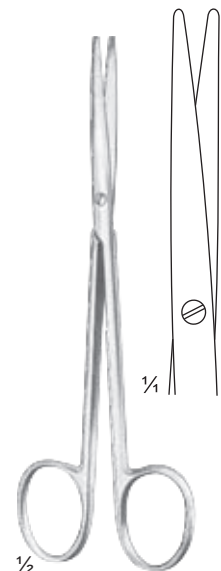

Metzenbaum-Fino
BS03-123-14
14.5 cm/5 1/2"



BS03-125-14
14.5 cm/5 1/2"

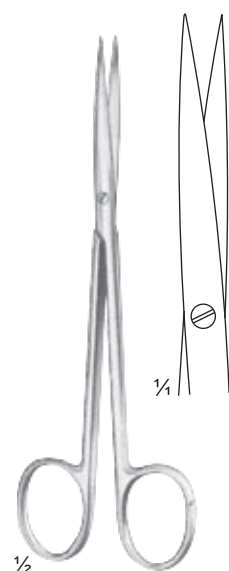

Metzenbaum-Fino
BS03-127-14
14.5 cm/5 1/2"



BS03-129-14
14.5 cm/5 1/2"

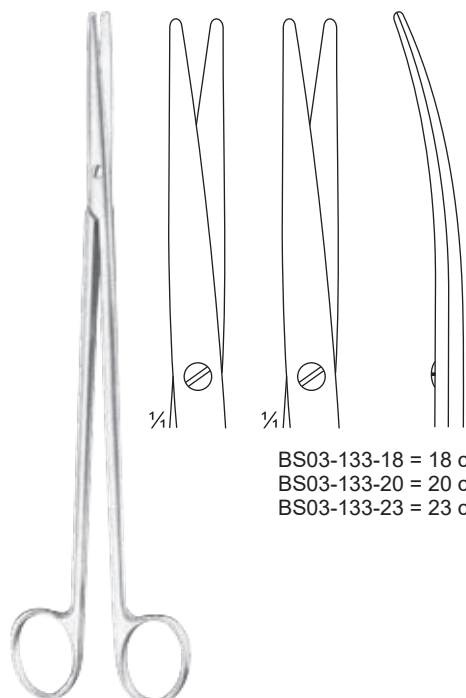

Metzenbaum-Fino
BS03-131-18 = 18 cm/7"
BS03-131-20 = 20 cm/8"
BS03-131-23 = 23 cm/9"

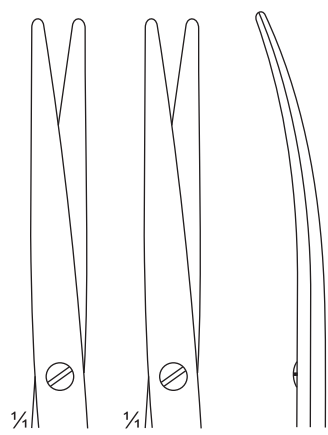

BS03-133-18 = 18 cm/7"
BS03-133-20 = 20 cm/8"
BS03-133-23 = 23 cm/9"

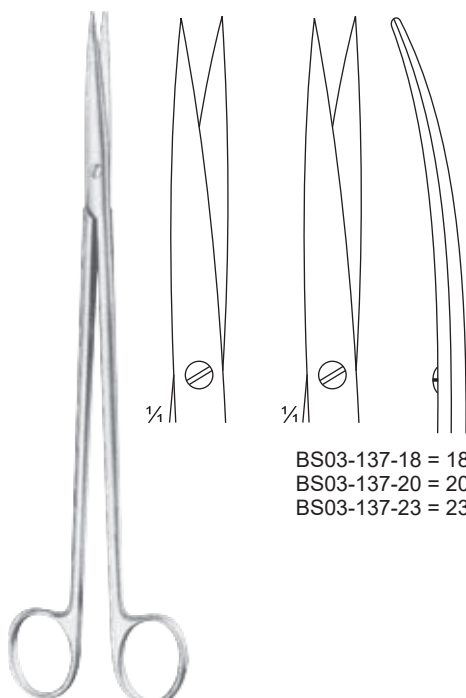

Metzenbaum-Fino
BS03-135-18 = 18 cm/7"
BS03-135-20 = 20 cm/8"
BS03-135-23 = 23 cm/9"

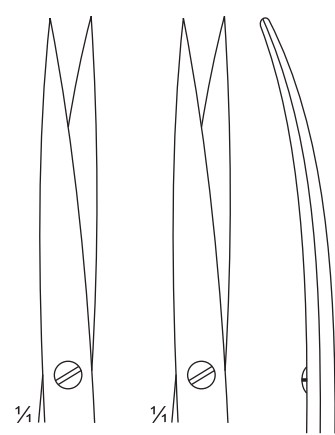

BS03-137-18 = 18 cm/7"
BS03-137-20 = 20 cm/8"
BS03-137-23 = 23 cm/9"

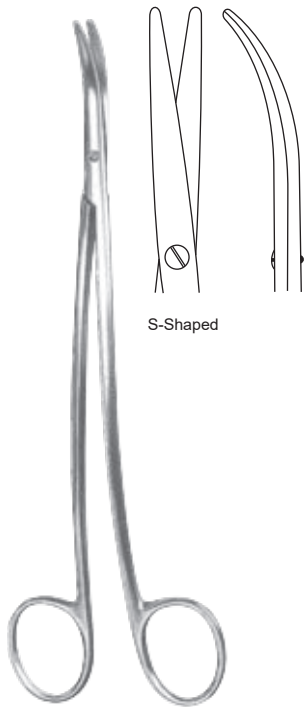

Metzenbaum-Fino
 BS03-139-18 = 18 cm/7"
 BS03-139-20 = 20 cm/8"
 BS03-139-23 = 23 cm/9"

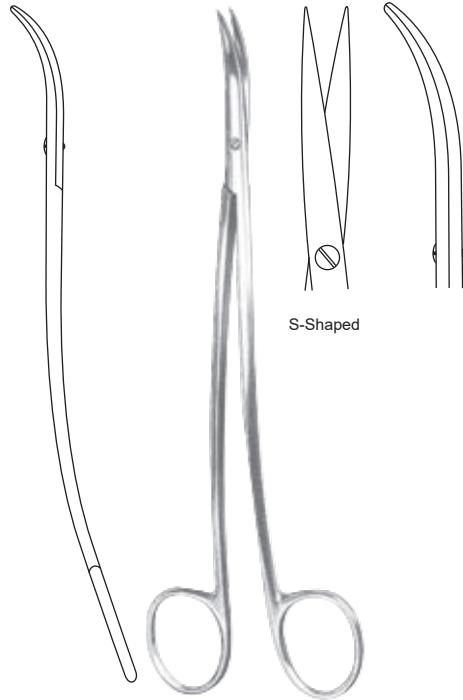

Metzenbaum-Fino
 BS03-141-18 = 18 cm/7"
 BS03-141-20 = 20 cm/8"
 BS03-141-23 = 23 cm/9"

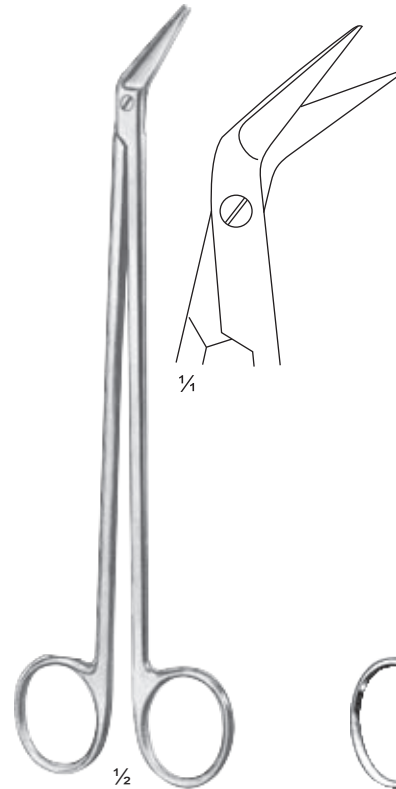

Potts-de Martel
 BS03-143-21 = 21 cm/8 1/4"
 BS03-143-24 = 24 cm/9 1/2"



Mc Indoe
 BS03-145-19
 19 cm/7 1/2"

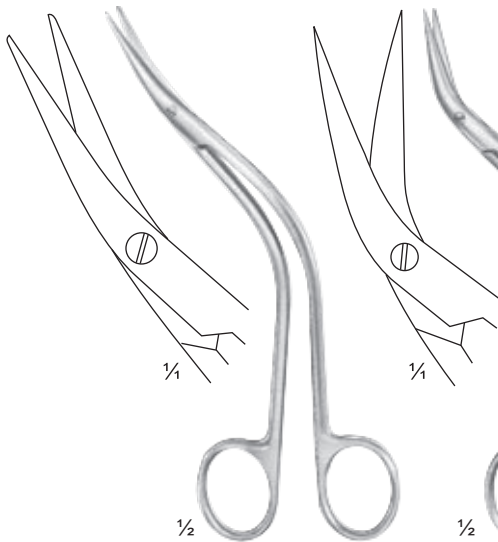

DeBailey
 BS03-147-20
 15.5 cm/6"



DeBailey
 BS03-149-45
 15.5 cm/6"



Favaloro
 BS03-151-90
 15 cm/6"



BS03-153-11
 11.5 cm/4 1/2"

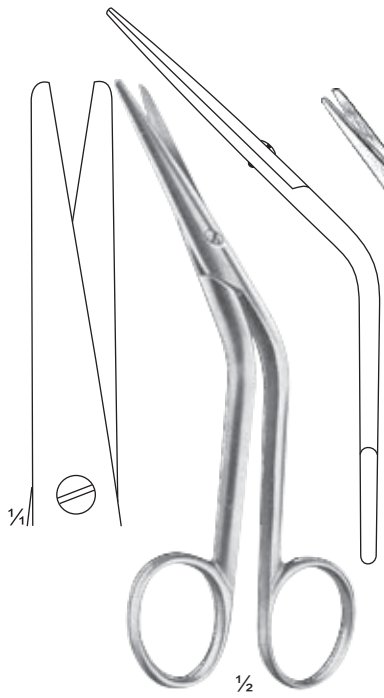

Cottle
BS03-155-15
16 cm/6 1/2"

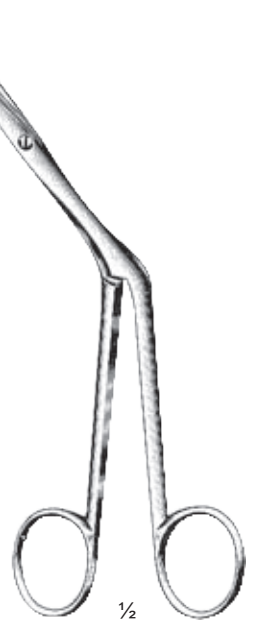

Heymann
BS03-157-18
18 cm/7"
Nasal Scissors



Waldmann
BS03-159-18
18 cm/7 1/4"
Nasal Scissors



Braun-Stadler
BS03-161-14
14.5 cm/5 1/2"
Episiotomy Scissors



Braun-Stadler
BS03-163-22
22 cm/8 3/4"
Episiotomy Scissors

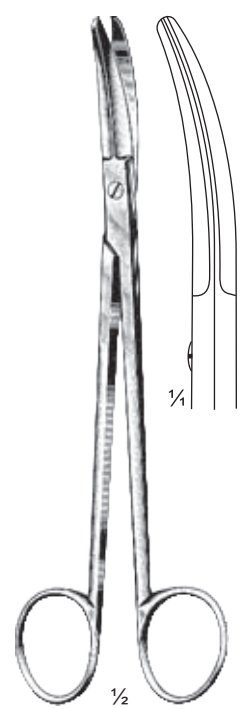

Beottcher
BS03-165-18
18 cm/7"
Tonsil Scissors

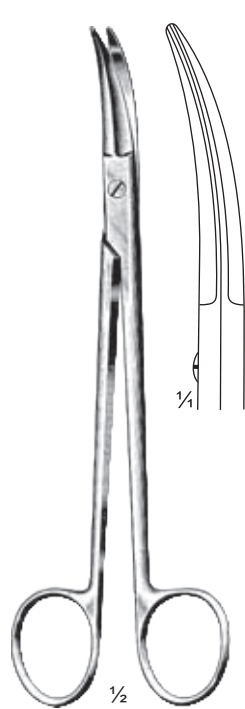

Prince
BS03-167-16
17.5 cm/7"
Tonsil Scissors

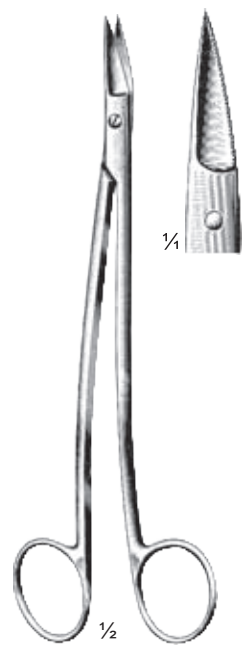

Dean
BS03-169-16
17 cm/6 3/4"
Tonsil Scissors

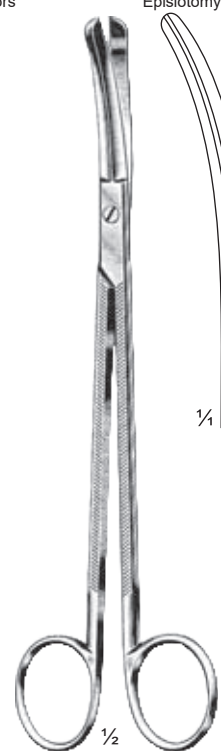

Good
BS03-171-19
19 cm/7 1/2"
Tonsil Scissors

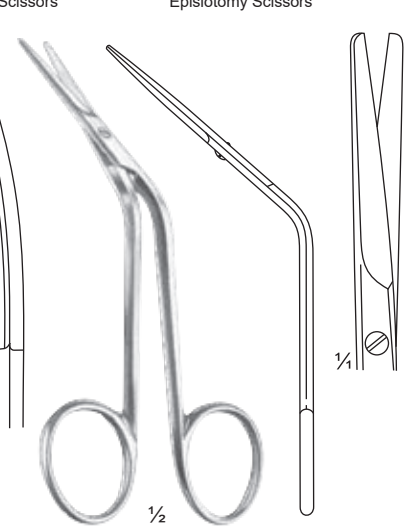

Fomon
BS03-173-15
15 cm/6"

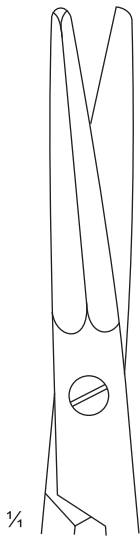

BS03-175-17
straight

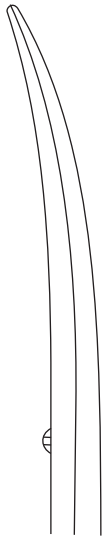

BS03-176-17
curved

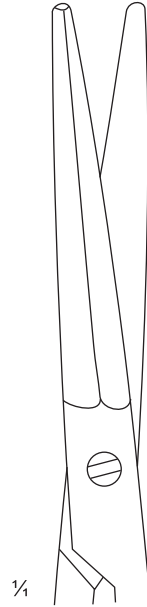
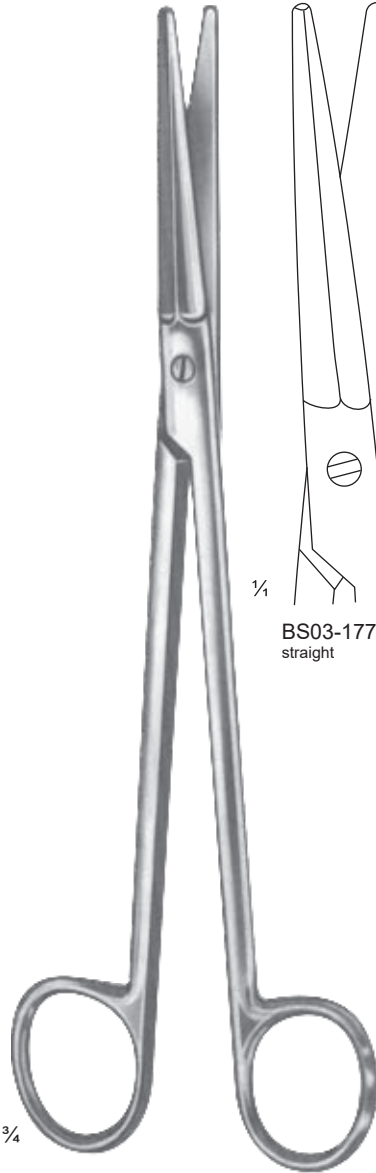

BS03-177-20
straight

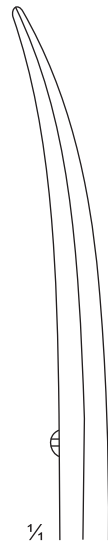

BS03-178-20
curved

Rees (Face Lifting)
17 cm/6 3/4"

Gorney
20 cm/8"

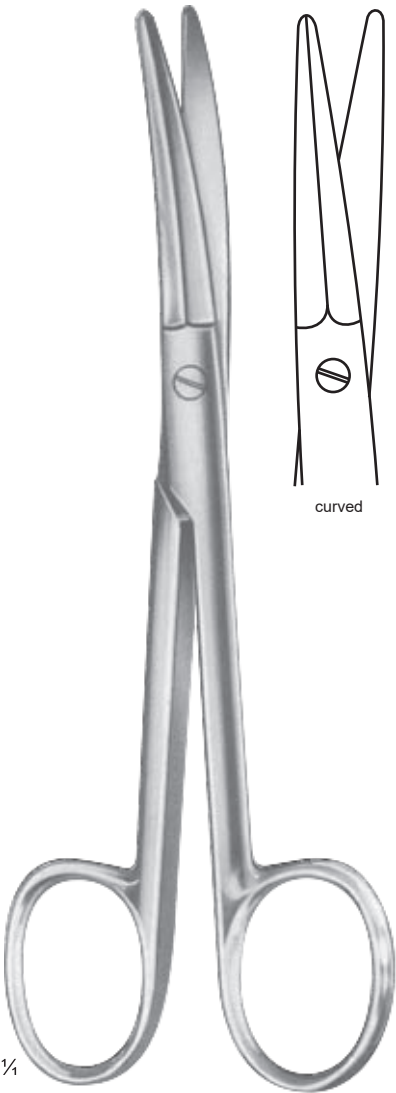

Aufricht
BS03-179-14
14.5cm/5 ¾"

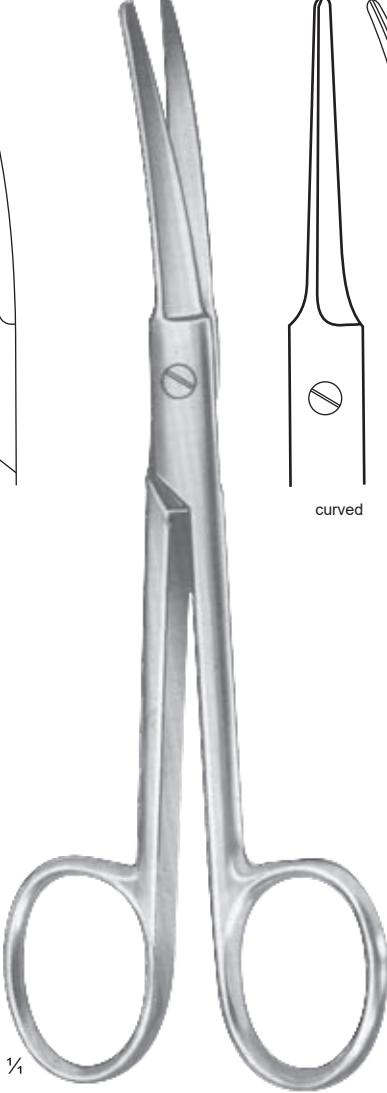

Brown (Mod.)
BS03-181-14
14.5cm/5 ¾"

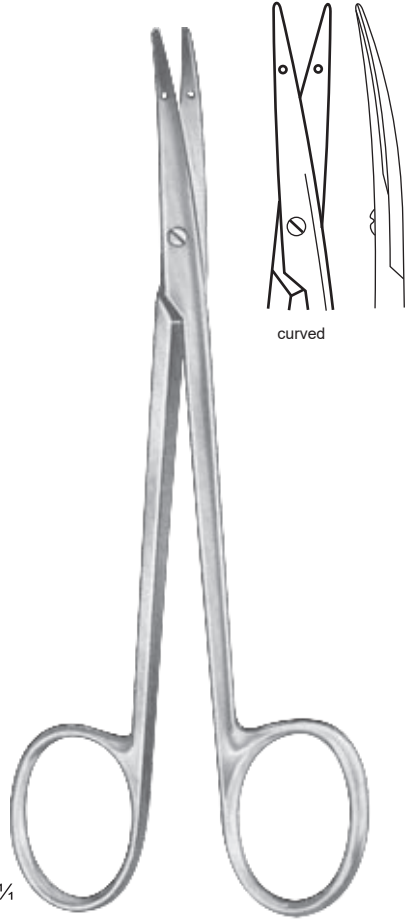

Littler Plastic
BS03-183-12
12cm/4 ¾"

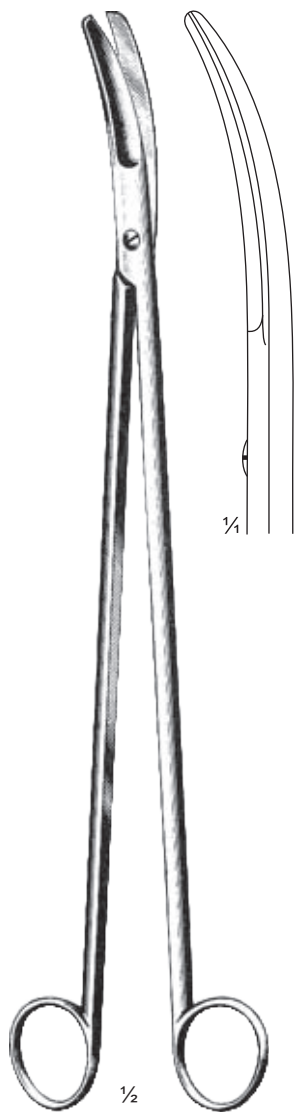

Crafoord
BS03-185-30
30 cm/12"

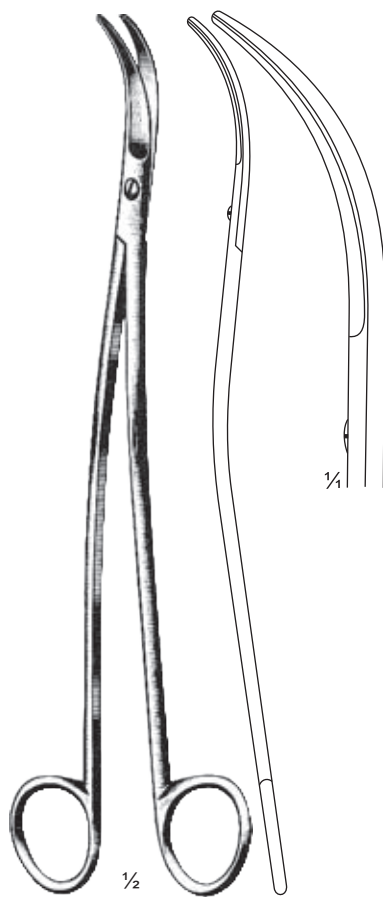

Satinsky
BS03-187-24
24.5 cm/10"

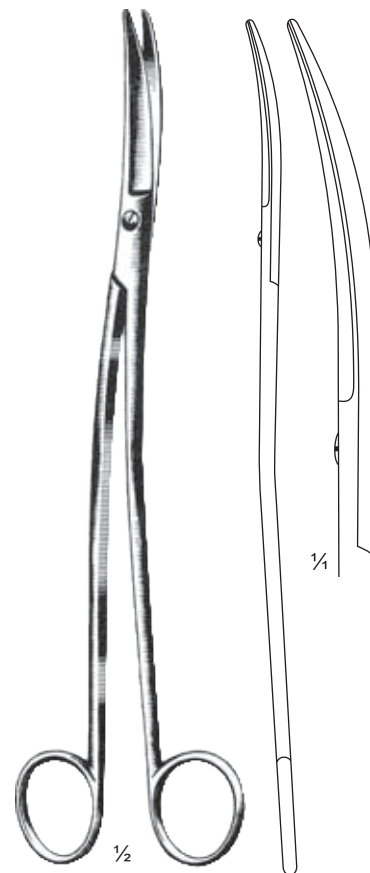

Klinkenbergh-Loth
BS03-189-23
23 cm/9"

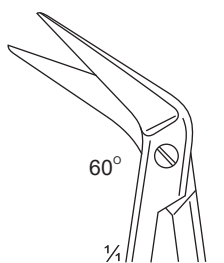

BS03-191-19

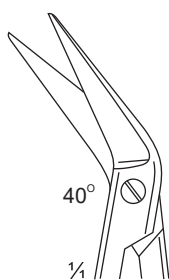

BS03-193-19

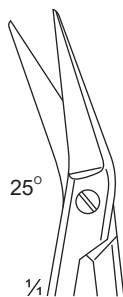

BS03-195-19

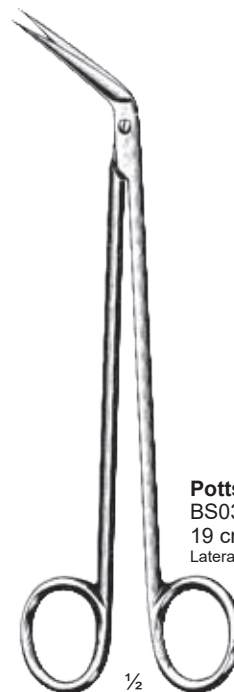

Potts-Smith
BS03-191-19 - BS03-195-19
19 cm/7 1/2"
Laterally angled

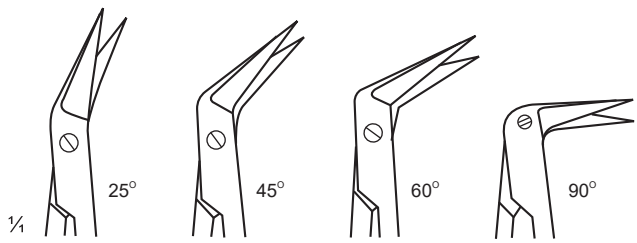

13 cm/5"
BS03-197-25 BS03-197-45 BS03-197-60 BS03-197-90

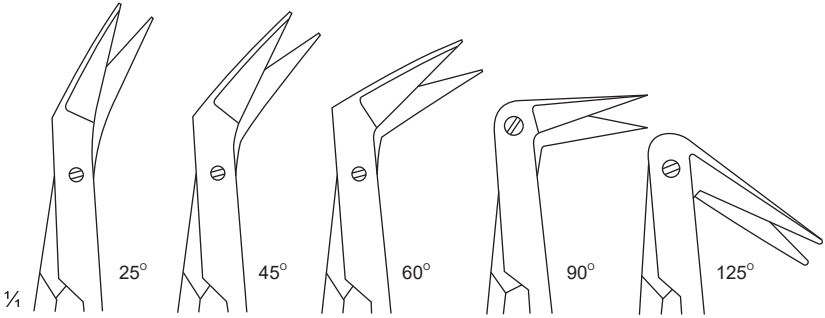

18 cm/7"
BS03-199-25 BS03-199-45 BS03-199-60 BS03-199-90 BS03-199-99



Diethrich
BS03-197-25 - BS03-199-99

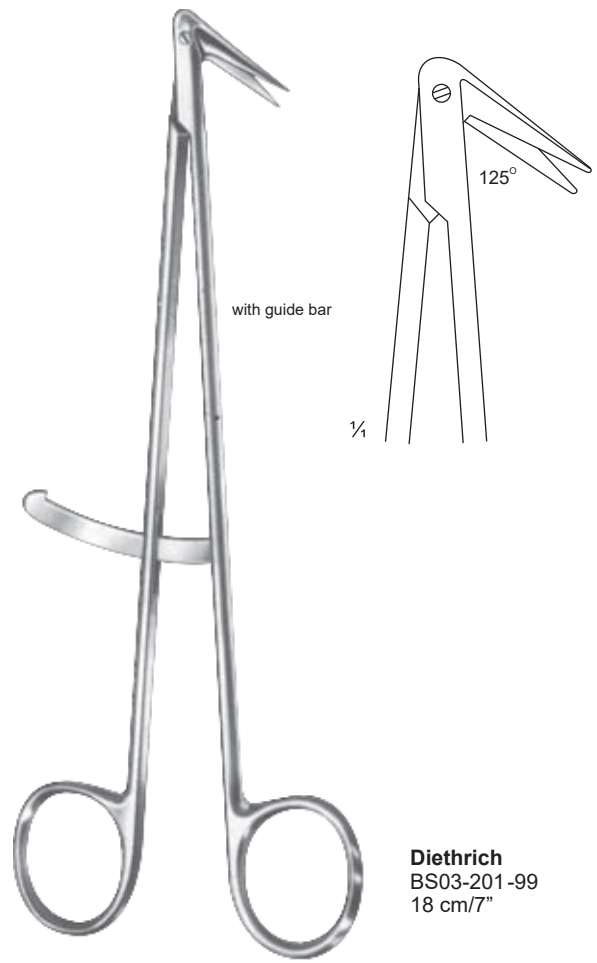

Diethrich
BS03-201-99
18 cm/7"

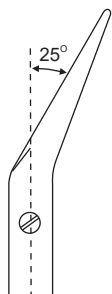

DC02-203-25
16 cm/6 1/4"

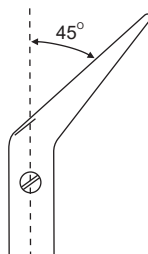

DC02-203-45
16 cm/6 1/4"

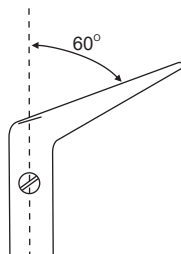

DC02-203-60
16 cm/6 1/4"

DC02-205-25
23 cm/9"

DC02-205-45
23 cm/9"

DC02-205-60
23 cm/9"

DC02-207-25
28 cm/11"

DC02-207-45
28 cm/11"

DC02-207-60
28 cm/11"



DeBakey

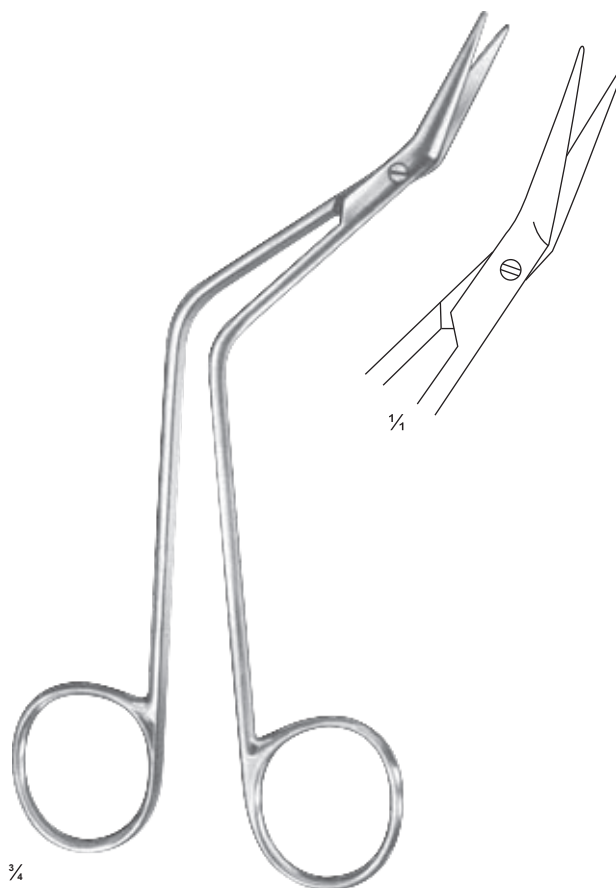

3/4

Coronary
DC02-209-17
17 cm/6 3/4"

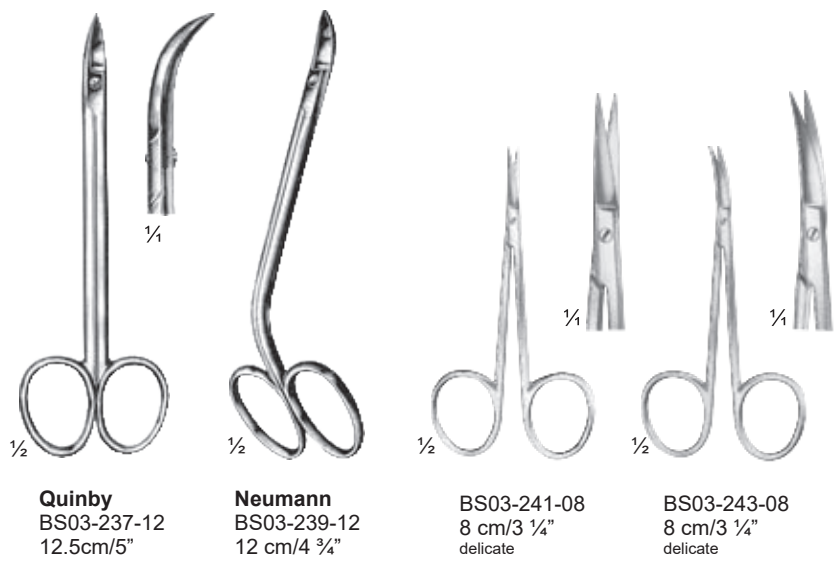
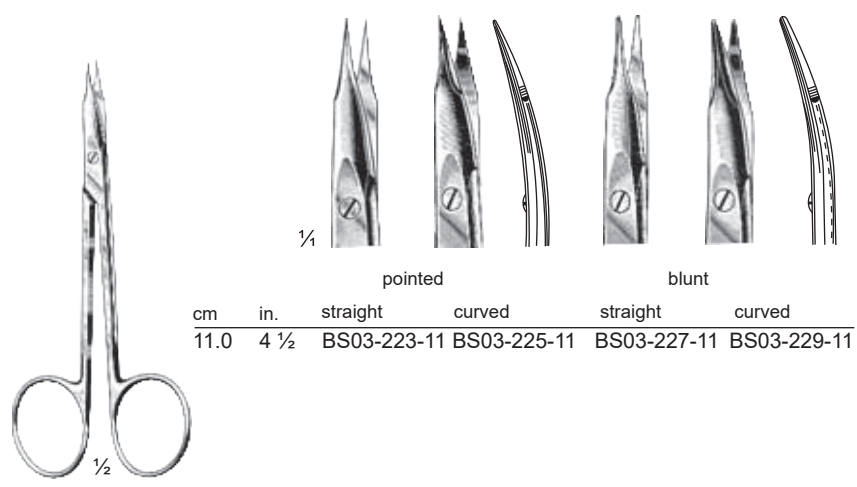

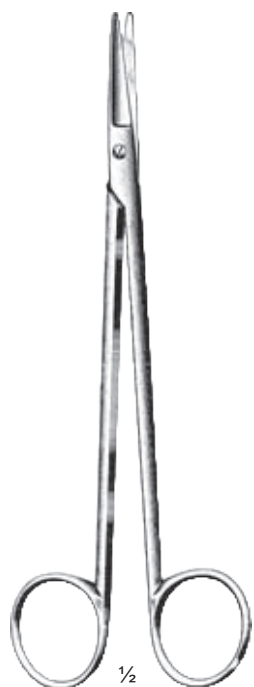

Toennis
BS03-249-18
18 cm/7"

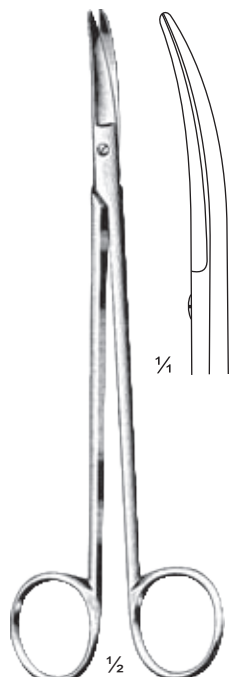

Toennis
BS03-251-18
18 cm/7"

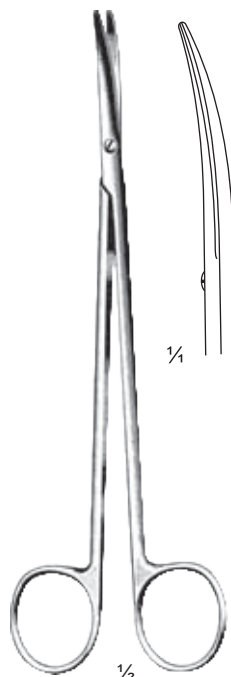

Toennis-Adson
BS03-253-17
17.5 cm/7"

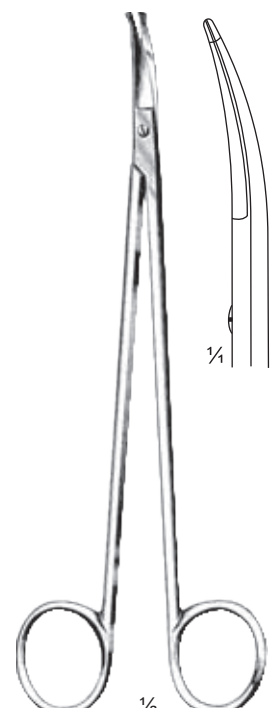

Strully
BS03-255-22
22 cm/8 1/2"

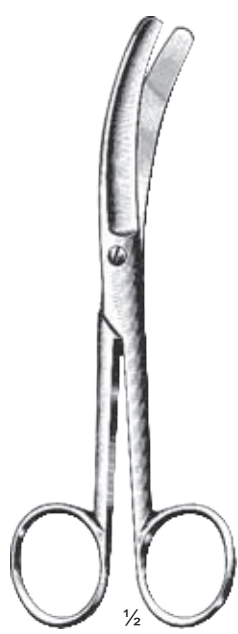

Busch
BS03-257-16
16 cm/6 1/4"



Dandy
BS03-259-17
17 cm/6 3/4"



Schmieden-Taylor
BS03-261-17
17 cm/6 3/4"



Mod. USA
BS03-263-10
10.5 cm/4 1/4"

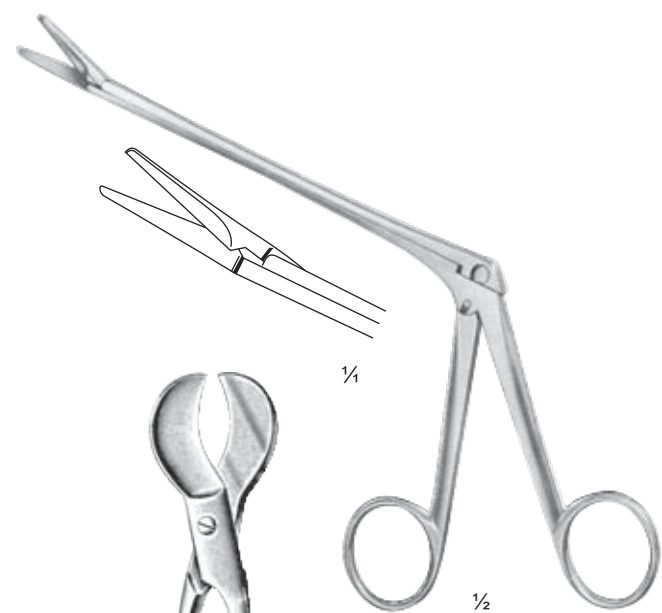

Olivecrona
BS03-265-23
23 cm/9"

Gum Scissors

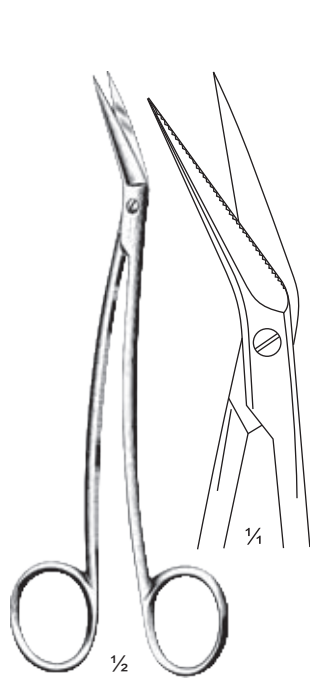

Locklin
BS03-267-16
16 cm/6 1/4"

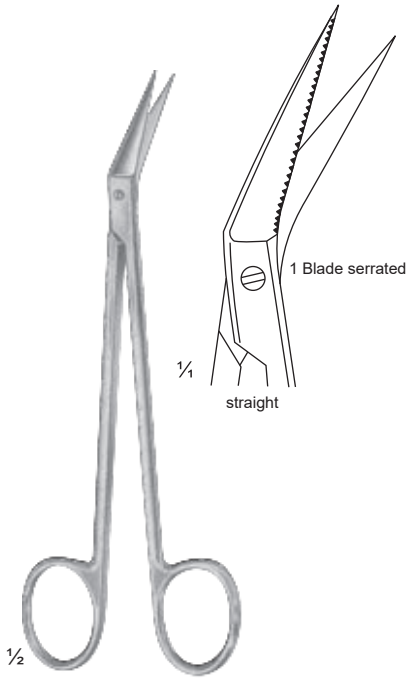

Locklin
BS03-269-16
16 cm/6 1/4"

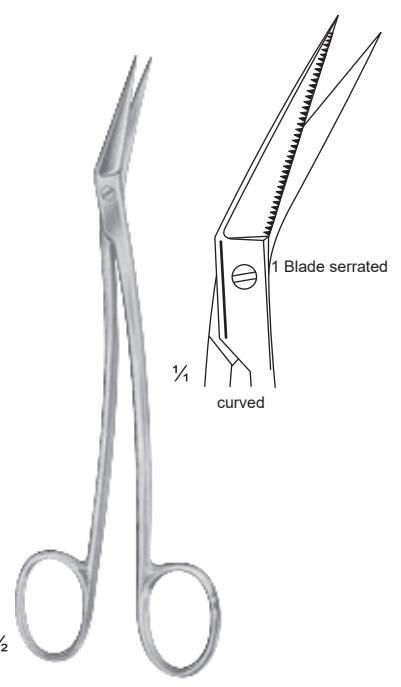

Locklin
BS03-271-16
16 cm/6 1/4"

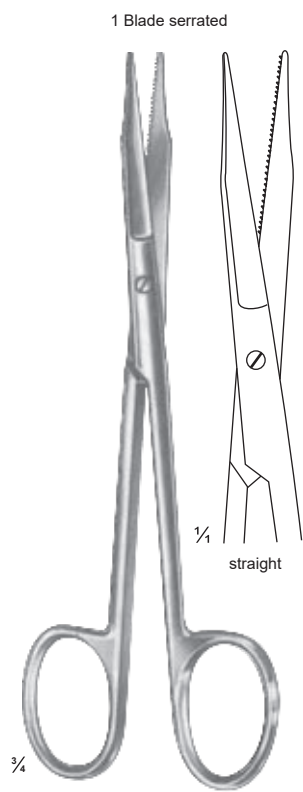

Goldmann-Fox
BS03-273-13
13 cm/5"
Umbilical Scissors

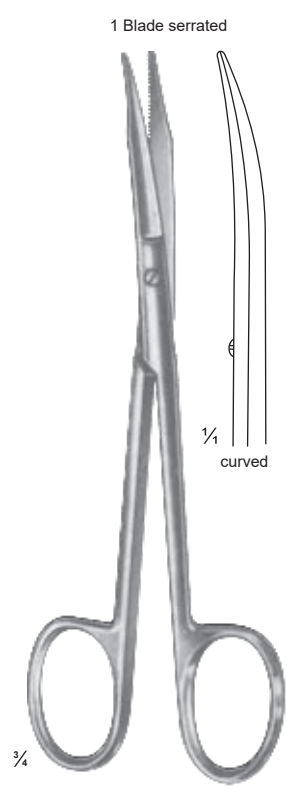

Goldmann-Fox
BS03-275-13
13 cm/5"

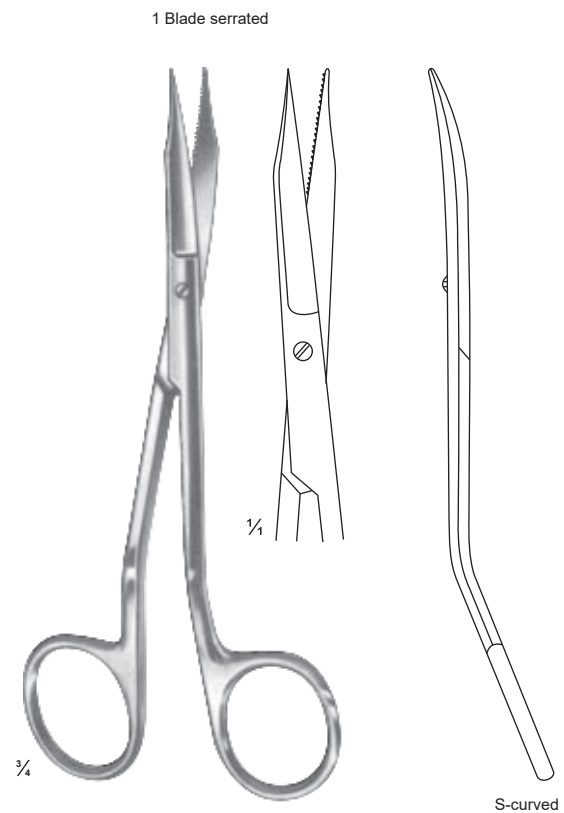

Goldmann-Fox
BS03-277-13
13 cm/5"
Umbilical Scissors



BS03-279-13
13 cm/5"



Spencer
BS03-281-09
9 cm/3 1/2"



Spencer
BS03-283-13
13 cm/5"



Buck
BS03-285-14 = 14.5 cm/5 1/2"
BS03-285-18 = 18 cm/7"



Littauer
BS03-287-14
14 cm/5 1/2"

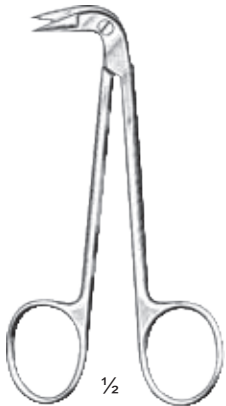

BS03-289-10
10.5 cm/4"
saw edge



Mod. Martin
BS03-291-15
15.5 cm/6"
saw edge



Heath
BS03-293-15
15 cm/6"

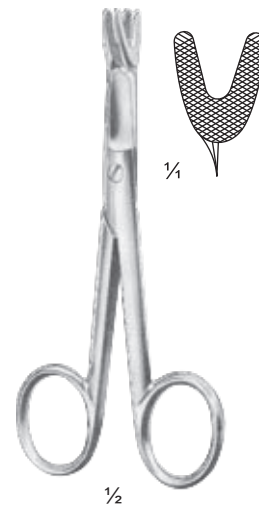

Schoemaker-Loth
BS03-295-13
13 cm/5"

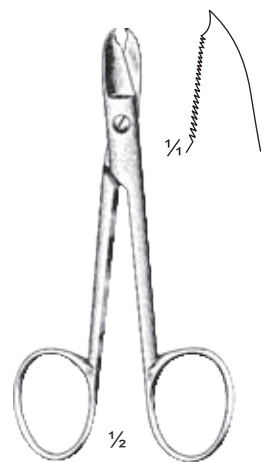

BS03-297-12
12 cm/4 3/4"
saw edge

Enterotomy, Nail Splitting Scissors & Wire & Plate Shears



BS03-299-21
21 cm/8 1/2"

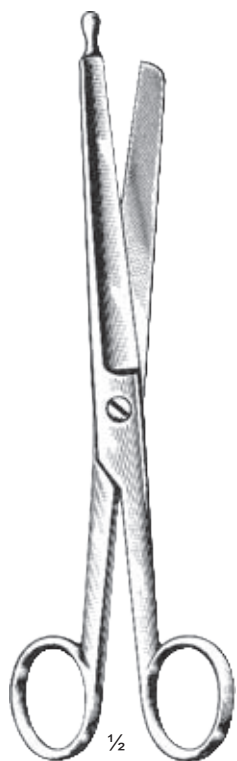

BS03-301-21
21 cm/8 1/2"



BS03-303-13 = 13 cm/5"
BS03-303-15 = 15 cm/6"

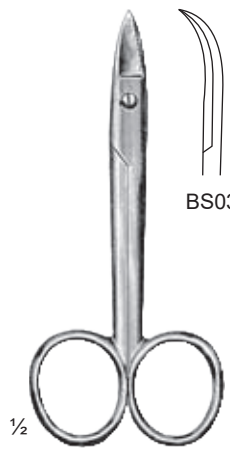

Special
BS03-305-12
saw edge

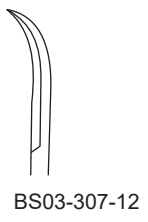

BS03-307-12

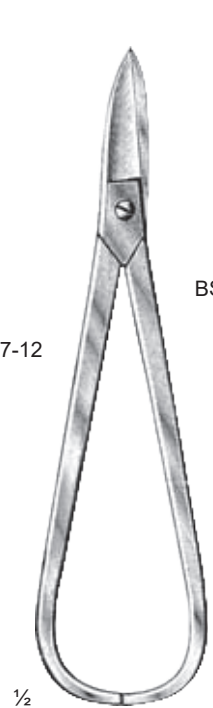

BS03-309-18
18 cm/7"

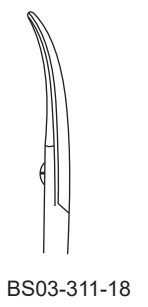

BS03-311-18



Universal
BS03-313-12
12 cm/4 3/4"
saw edge

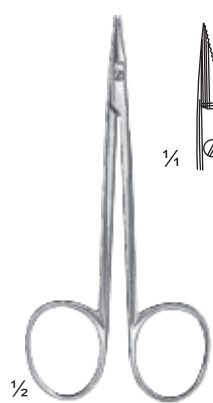

BS03-315-10
10 cm/4"
saw edge

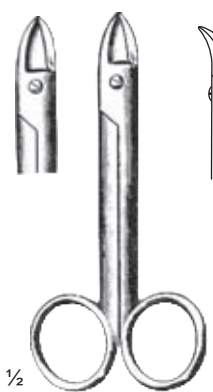
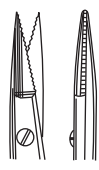

Beebee
blunt



Beebee
sharp



cm	in.	BS03-317-10	BS03-319-10	BS03-321-10	BS03-323-10
10.0	4				