



Forceps





Halsted-Mosquito

1 x 2 teeth

¼

BS05-001-12
12.5cm/5"



BS05-001-14
14cm/5½"



BS05-003-12
12.5cm/5"



BS05-003-14
14cm/5½"

¼

BS05-005-12
12.5cm/5"



BS05-005-14
14cm/5½"



BS05-007-12
12.5cm/5"



BS05-007-14
14cm/5½"

¼

BS05-009-18
18cm/7"



BS05-009-21
21cm/8¼"



BS05-011-18
18cm/7"



BS05-011-21
21cm/8¼"

¼

BS05-013-18
18cm/7"



BS05-013-21
21cm/8½"



BS05-015-18
18cm/7"



BS05-015-21
21cm/8¼"



Halsted-Mosquito

1 x 2 teeth

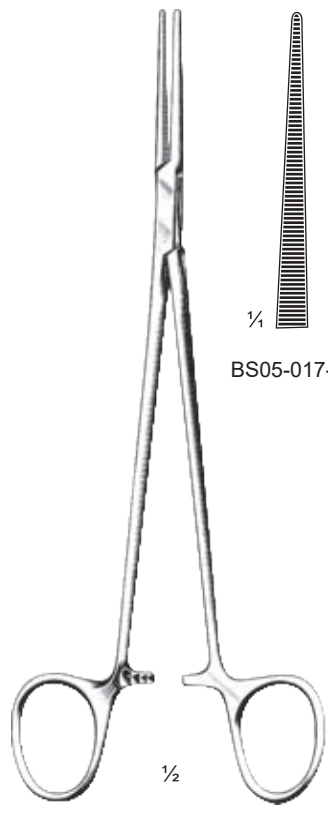

Heiss
20cm/8"



BS05-017-20

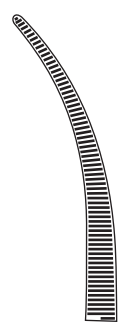

BS05-019-20

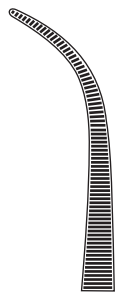

BS05-021-20



Bengolea

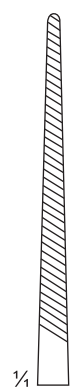

BS05-023-20
20cm/8"

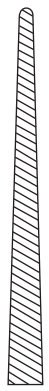

BS05-023-26
26cm/10 1/4"

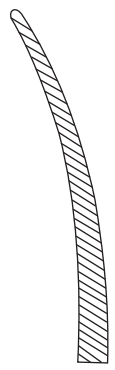

BS05-025-20
20cm/8"

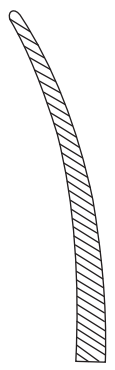

BS05-025-26
26cm/10 1/4"

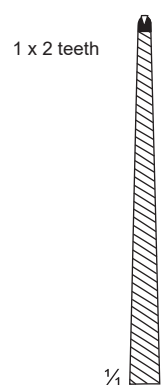

BS05-027-20
20cm/8"

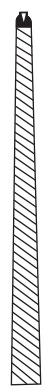

BS05-027-26
26cm/10 1/4"

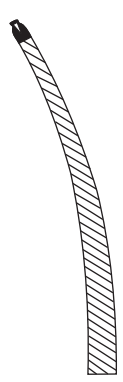

BS05-029-20
20cm/8"

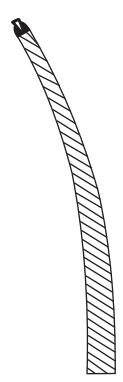

BS05-029-26
26cm/10 1/2"



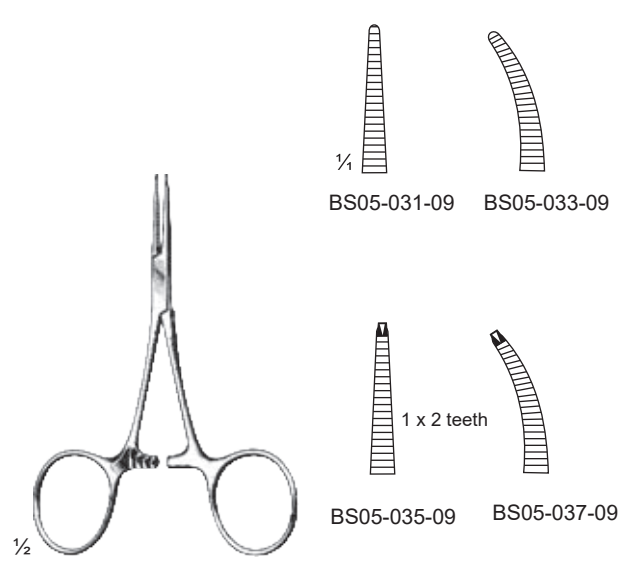

Hartmann
(Baby-Mosquito)
9.5cm/3 3/4"

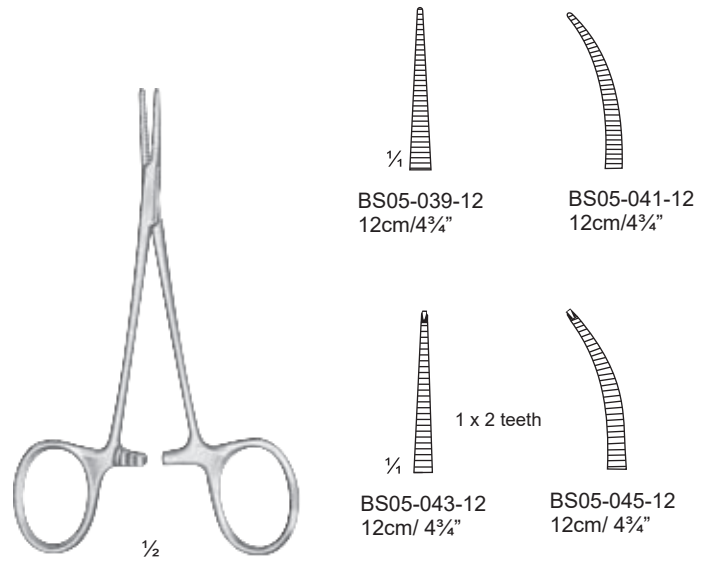

Micro-Mosquito

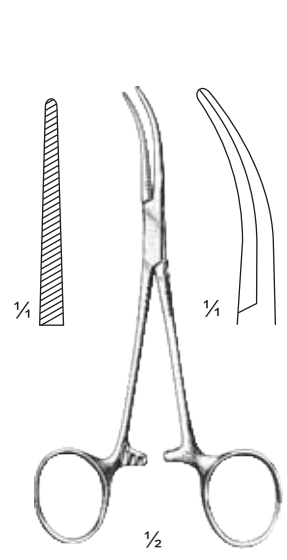

Mosquito-Dandy
BS05-047-12
12 cm/4 3/4"

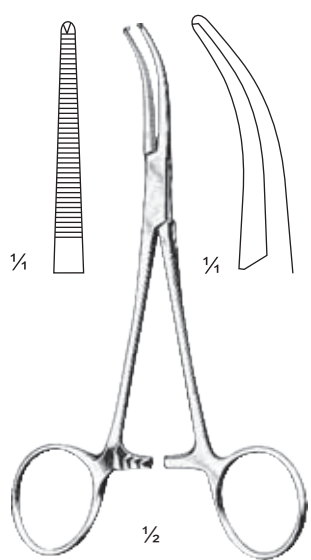

Dandy
BS05-049-14
1 : 2 Teeth

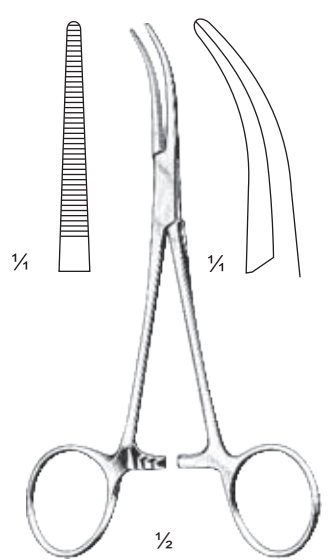

Dandy
BS05-051-14
14 cm/5 1/2"

Fine Hemostatic & Artery Forceps

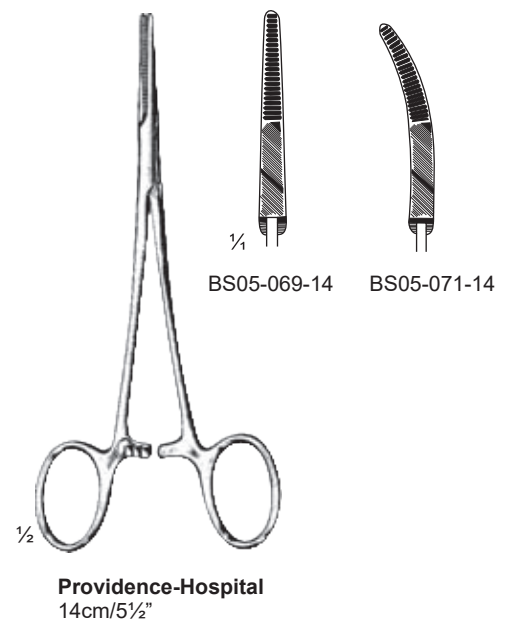
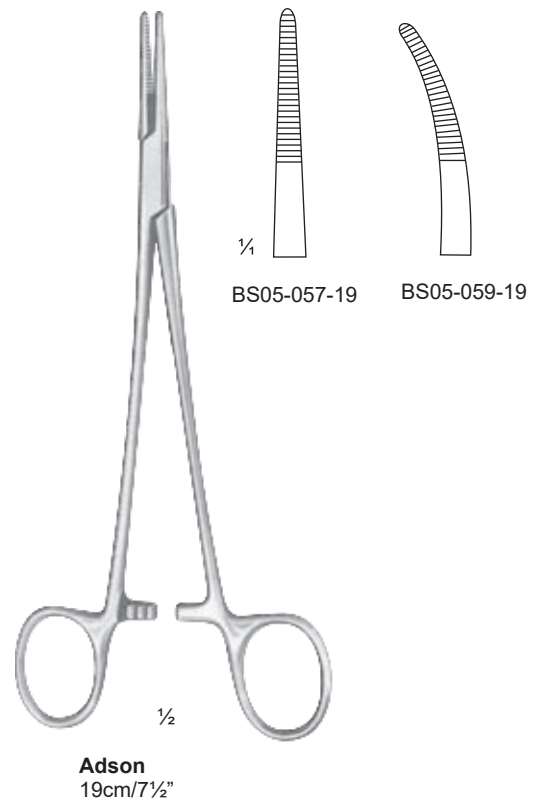
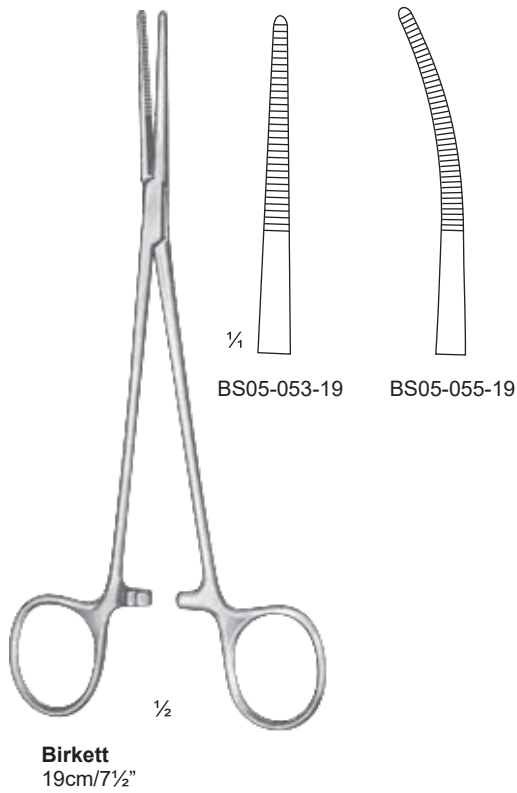

Fine Hemostatic Forceps

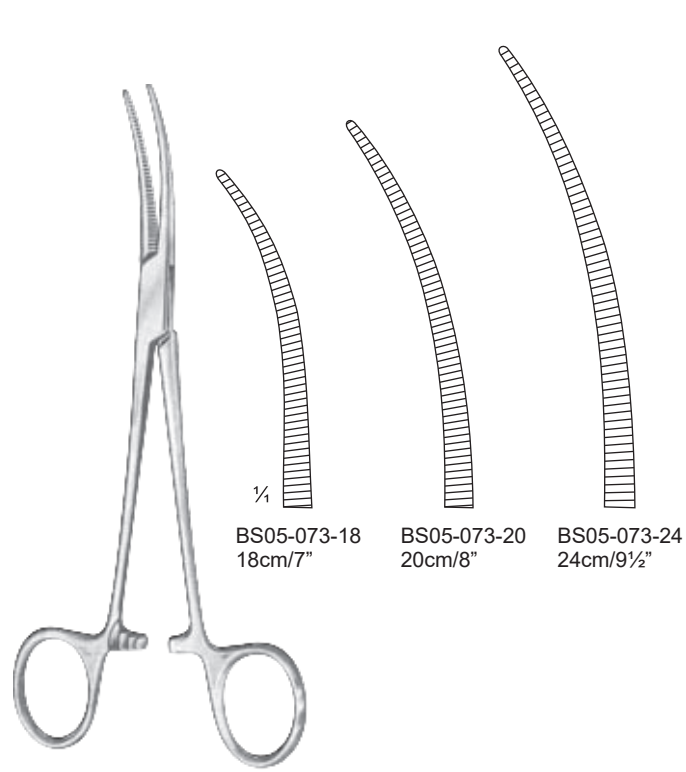

Crafoord(Coller)

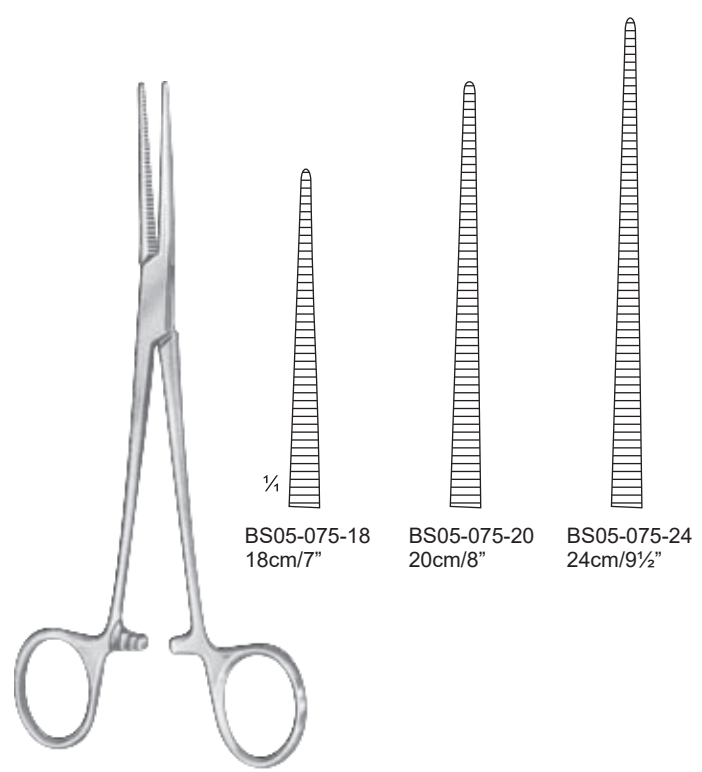

Olivecorona(Crafoord)

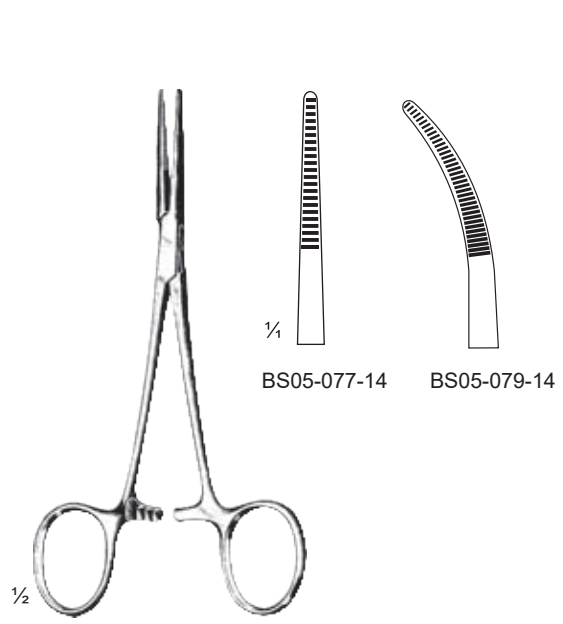

Kelly
14cm/5½"

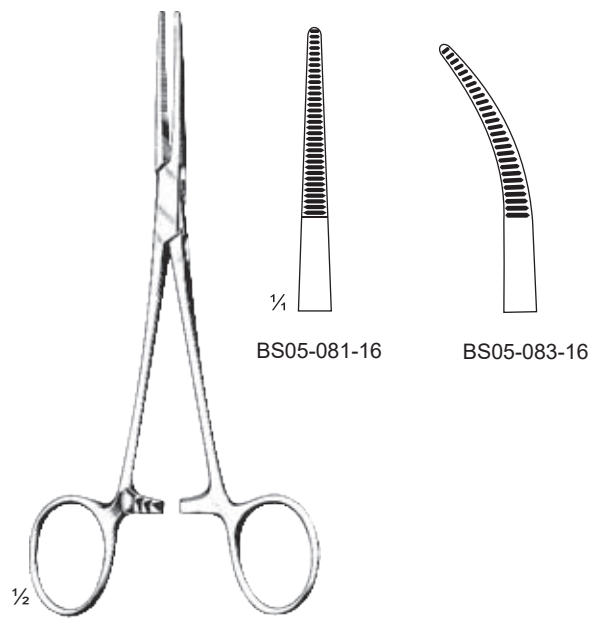

Rankin-Kelly
16cm/6¼"

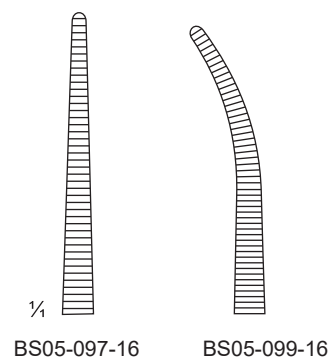
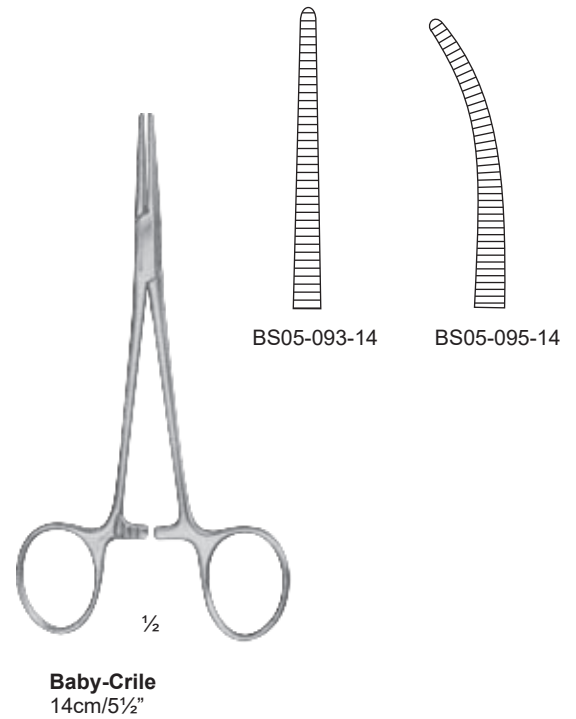
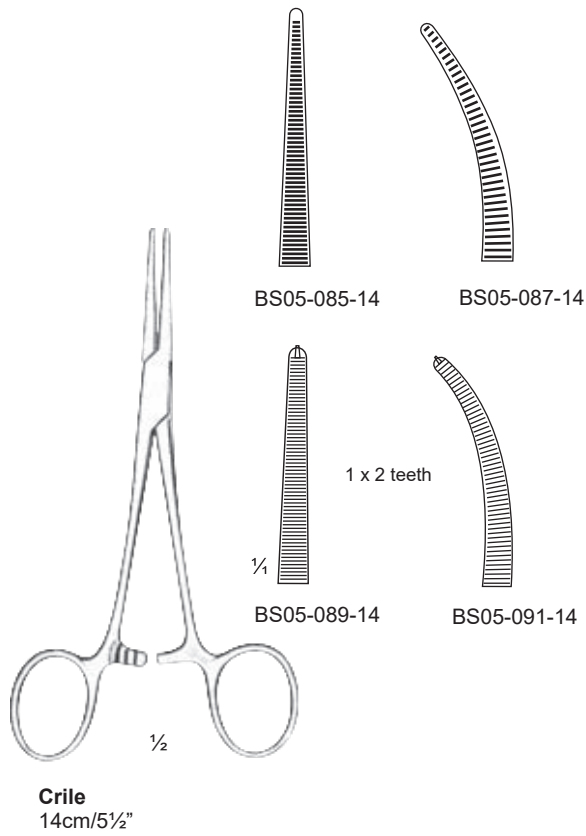

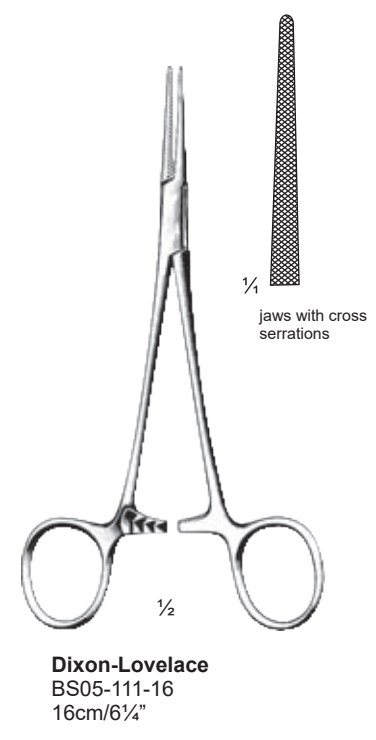
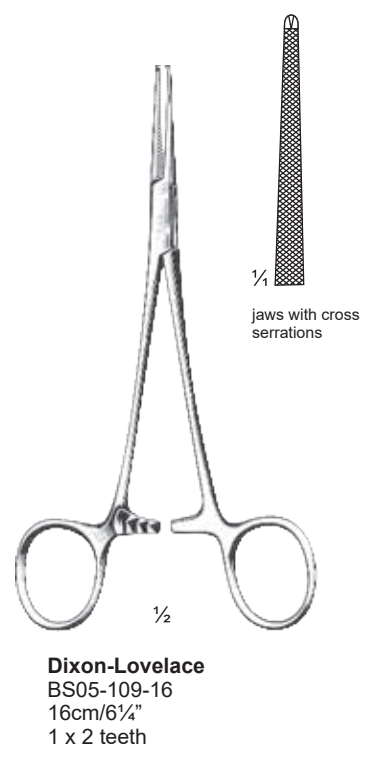
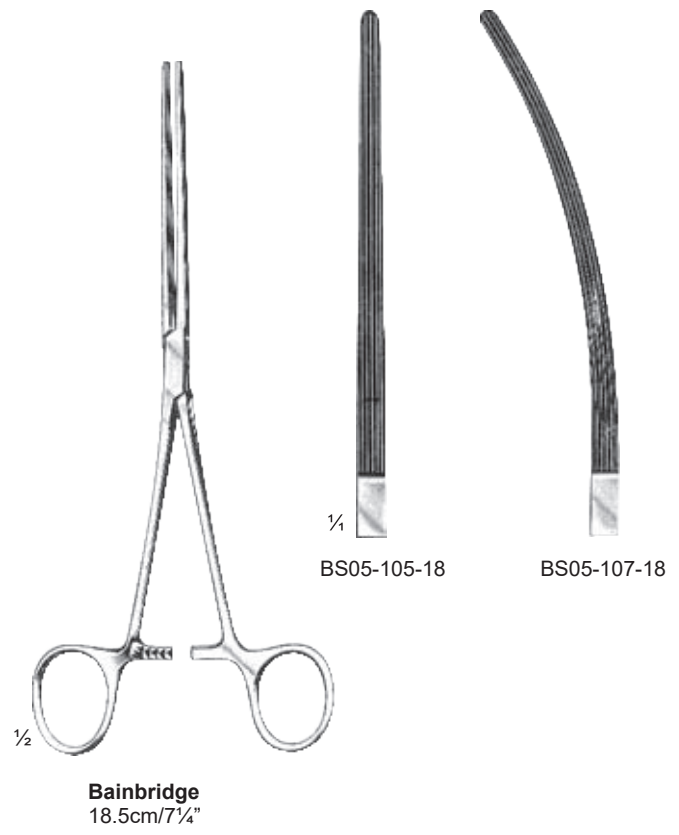
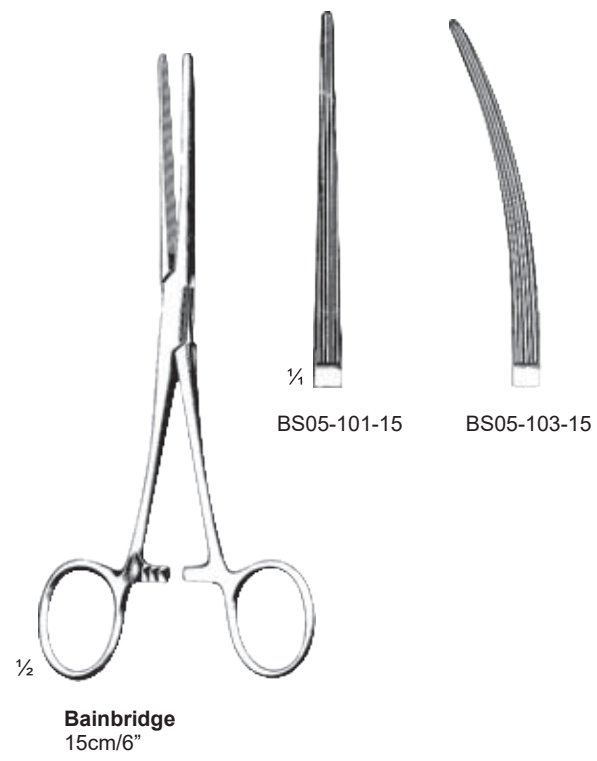

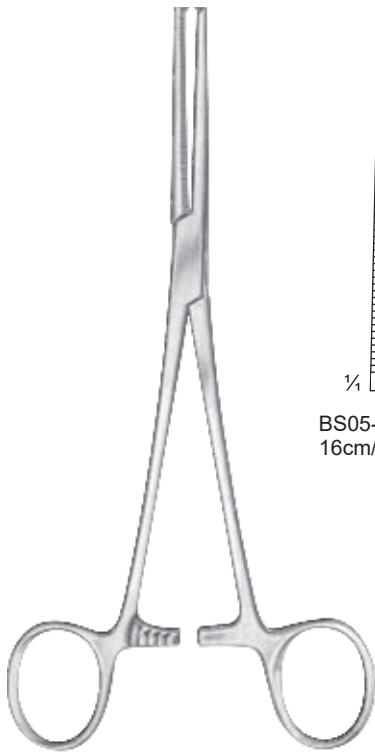

Rochester-Ochsner

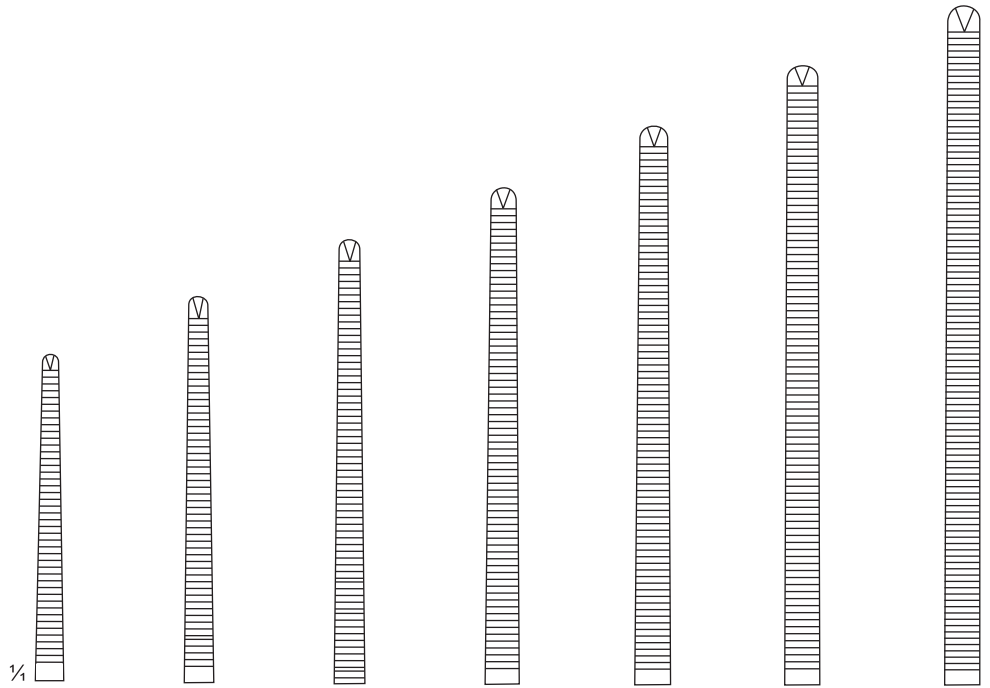

- BS05-113-16
16cm/6¼"
- BS05-113-18
18cm/7"
- BS05-113-20
20cm/8"
- BS05-113-22
22cm/8¾"
- BS05-113-24
24cm/9½"
- BS05-113-26
26cm/10¼"
- BS05-113-28
28cm/11"

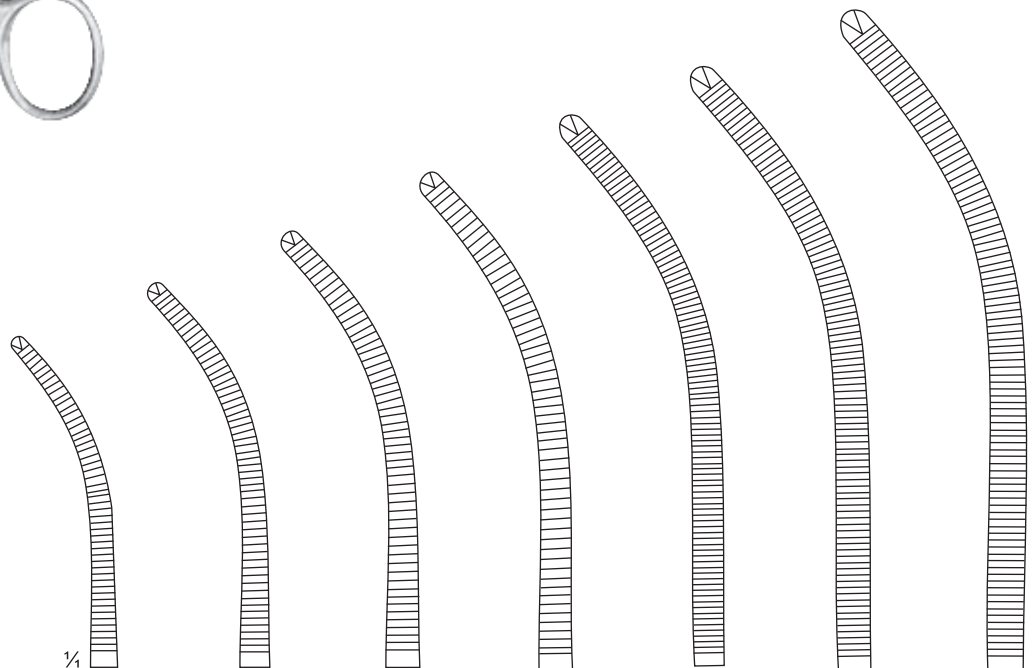

- BS05-115-16
16cm/6¼"
- BS05-115-18
18cm/7"
- BS05-115-20
20cm/8"
- BS05-115-22
22cm/8¾"
- BS05-115-24
24cm/9½"
- BS05-115-26
26cm/10¼"
- BS05-115-28
28cm/11"

Hemostatic Forceps

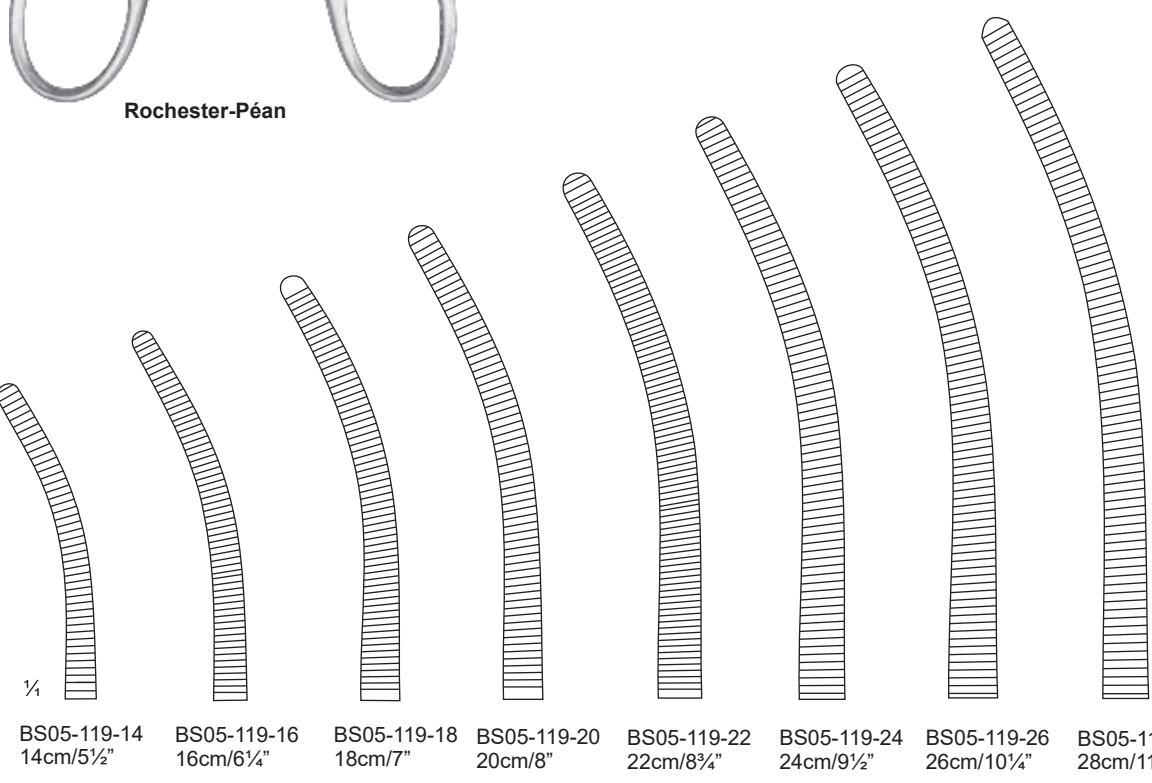
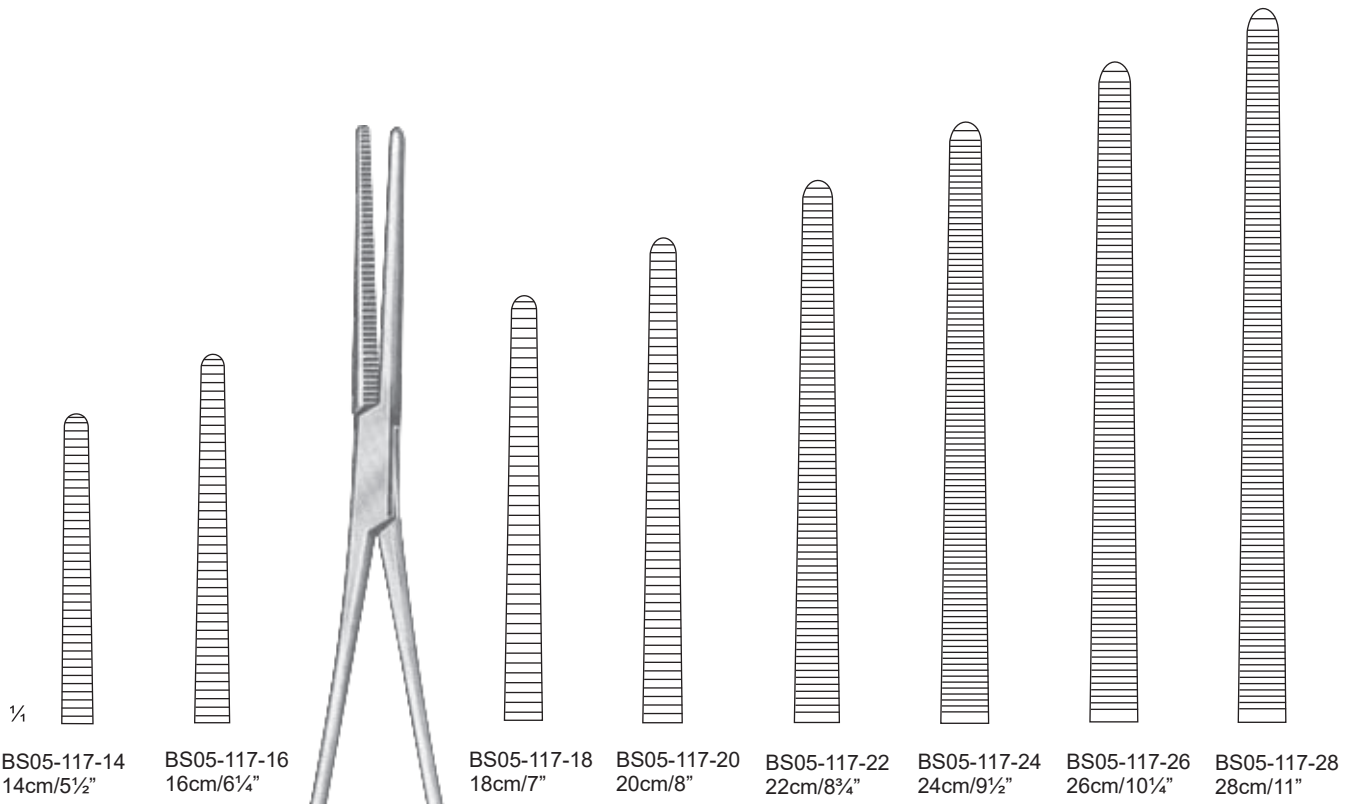

Rochester-Péan





Péan

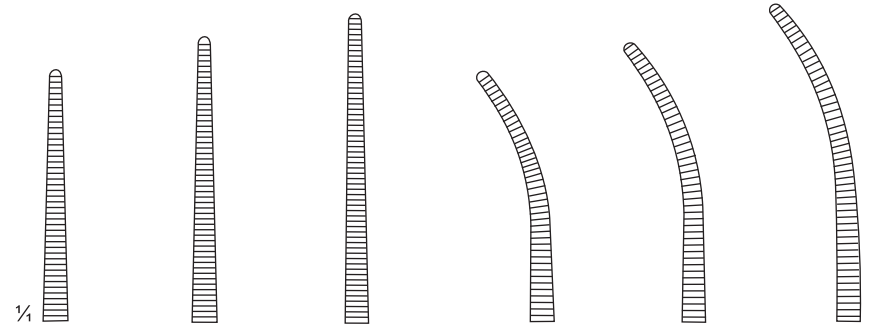

- | | | | | | |
|-------------------------|--------------------------|--------------------------|------------------------|-------------------------|-------------------------|
| BS05-121-13
13 cm/5" | BS05-121-14
14 cm/5½" | BS05-121-16
16 cm/6¼" | BS05-123-13
13cm/5" | BS05-123-14
14cm/5½" | BS05-123-16
16cm/6¼" |
|-------------------------|--------------------------|--------------------------|------------------------|-------------------------|-------------------------|



Rochester-Carmalt

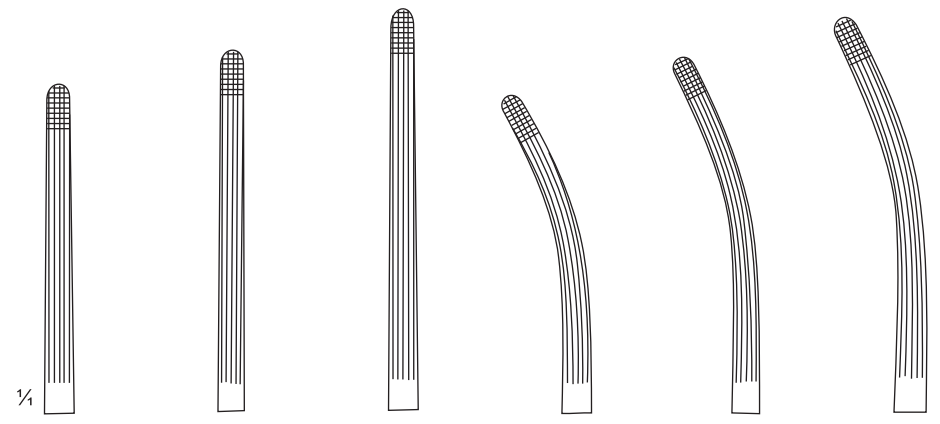

- | | | | | | |
|-------------------------|---------------------------|--------------------------|-------------------------|---------------------------|--------------------------|
| BS05-125-16
16cm/6¼" | BS05-125-18
18.5cm/7¼" | BS05-125-20
20.5cm/8" | BS05-127-16
16cm/6¼" | BS05-127-18
18.5cm/7¼" | BS05-127-20
20.5cm/8" |
|-------------------------|---------------------------|--------------------------|-------------------------|---------------------------|--------------------------|

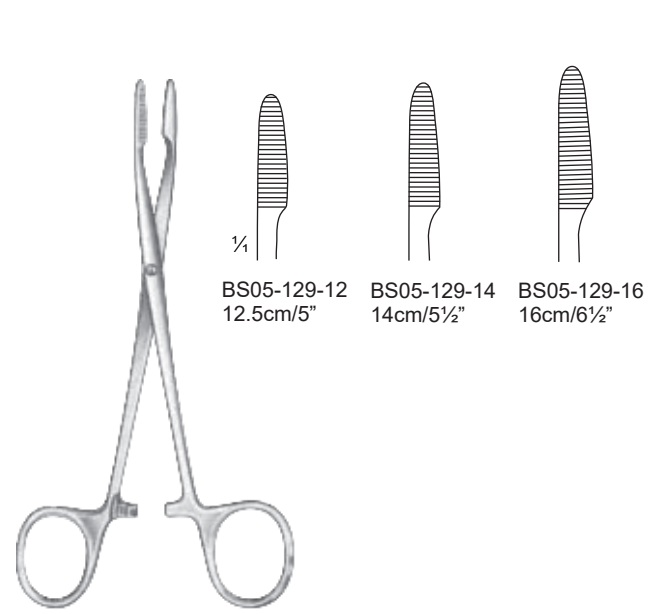

BS05-129-12 12.5cm/5"
 BS05-129-14 14cm/5½"
 BS05-129-16 16cm/6½"

Péan

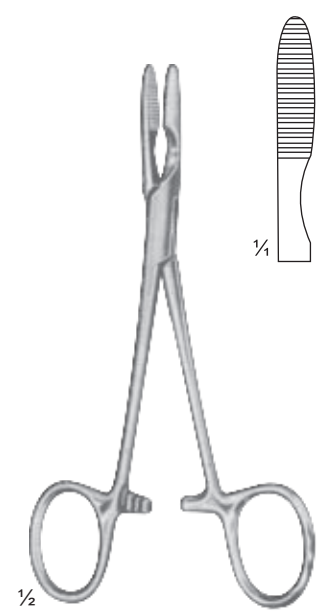

Péan
 BS05-131-14
 14.5cm/5¾"

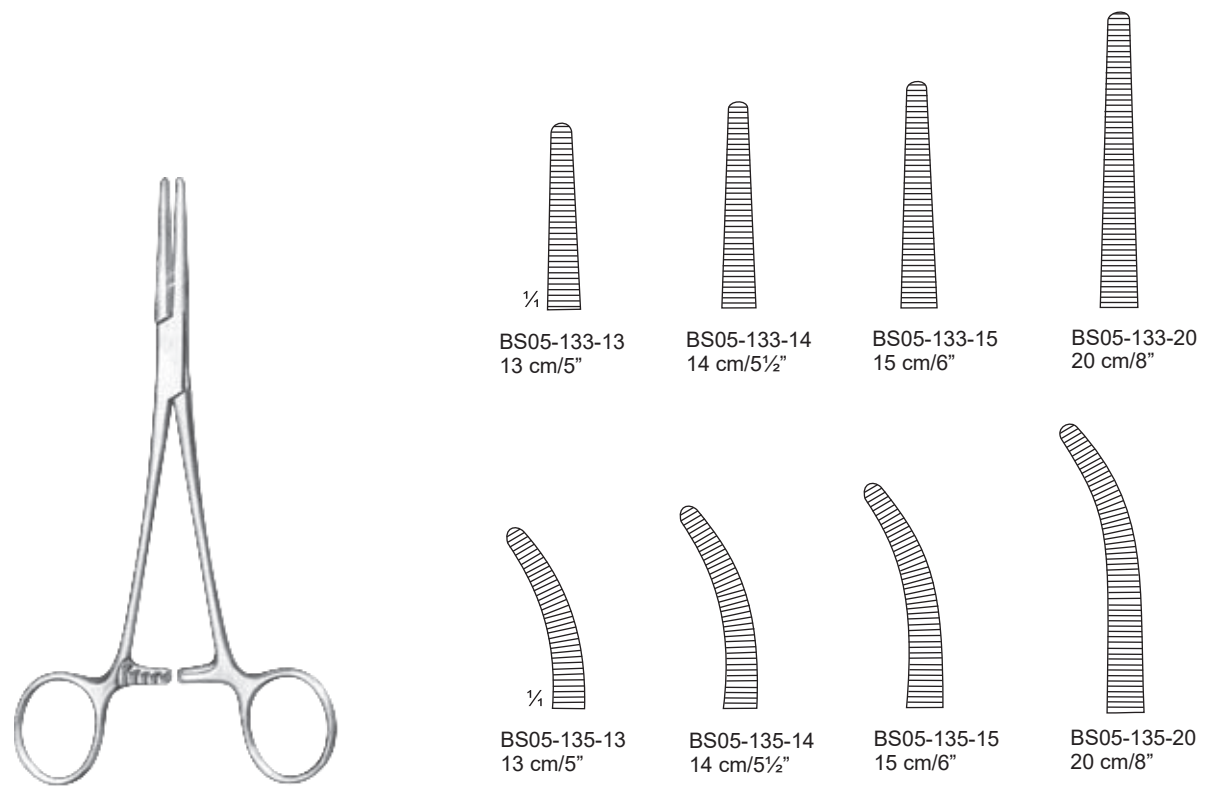

Spencer-Wells(Jones)

BS05-133-13 13 cm/5"
 BS05-133-14 14 cm/5½"
 BS05-133-15 15 cm/6"
 BS05-133-20 20 cm/8"
 BS05-135-13 13 cm/5"
 BS05-135-14 14 cm/5½"
 BS05-135-15 15 cm/6"
 BS05-135-20 20 cm/8"

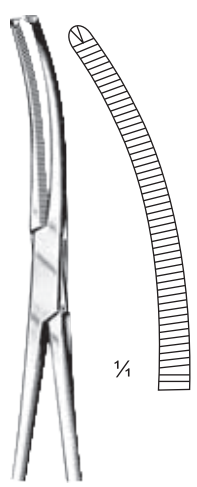
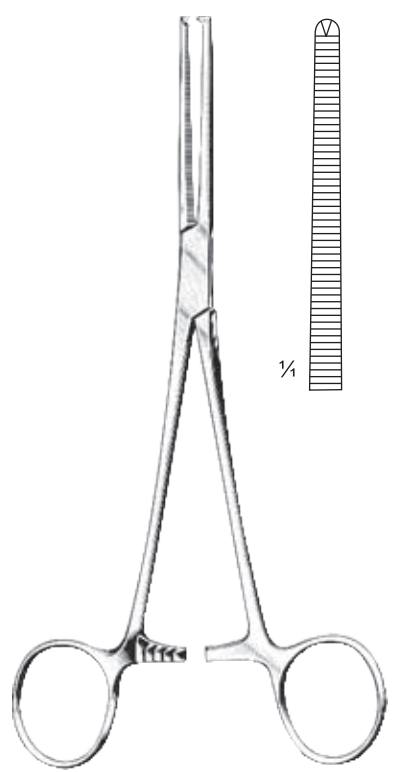

Kocher (Ochsner)

Kocher-Fine
14.5cm/5 3/4"

straight	1 : 2		curved
	cm	in.	
BS05-137-14	14	5 1/2	BS05-139-14
BS05-137-16	16	6 1/4	BS05-139-16
BS05-137-18	18	7	BS05-139-18
BS05-137-20	20	8	BS05-139-20
BS05-137-22	22	8 3/4	BS05-139-22
BS05-137-24	24	9 1/2	BS05-139-24
BS05-137-26	26	10 1/4	BS05-139-26
BS05-137-30	30	12	BS05-139-30

delicate pattern

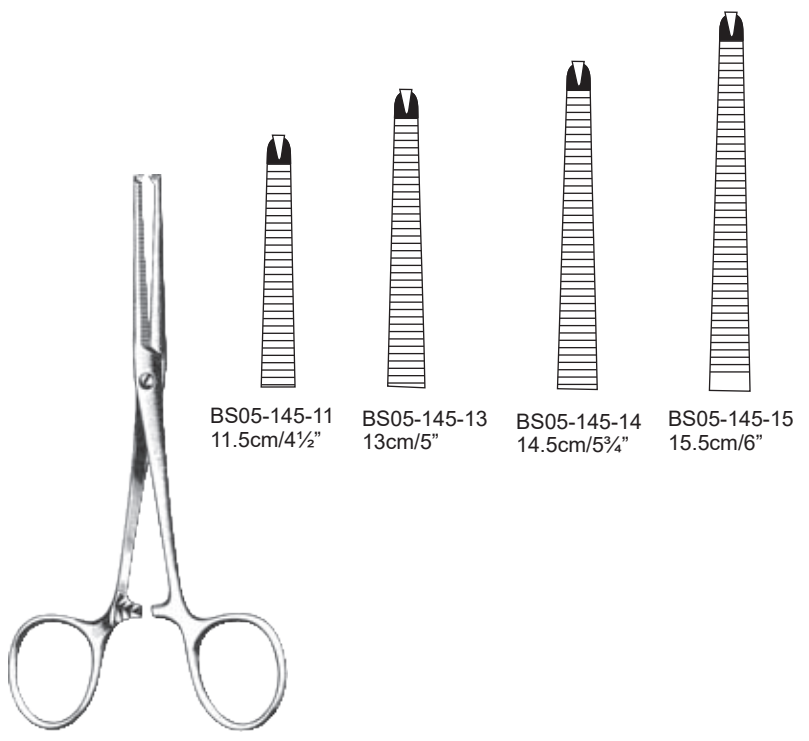

Kocher

- BS05-145-11
11.5cm/4 1/2"
- BS05-145-13
13cm/5"
- BS05-145-14
14.5cm/5 3/4"
- BS05-145-15
15.5cm/6"

Dissecting and Hemostatic Forceps

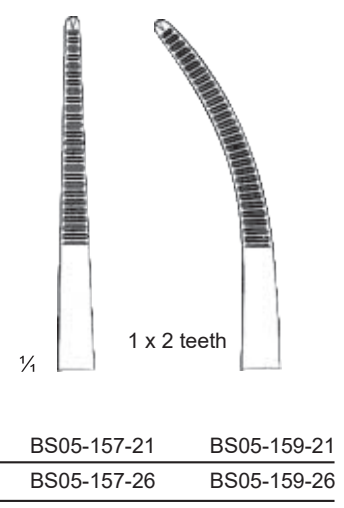
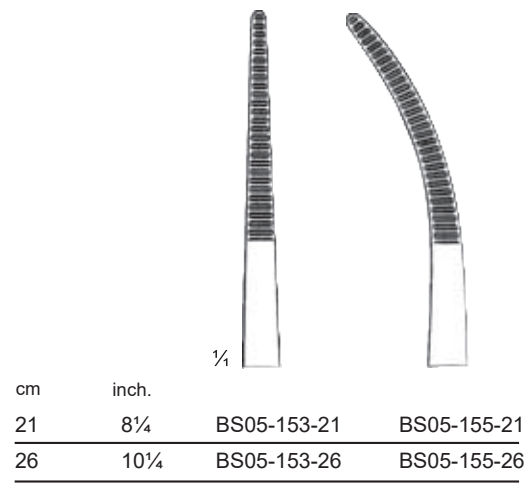
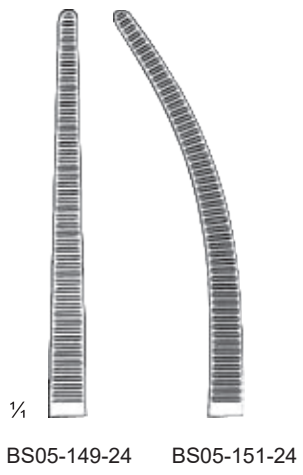
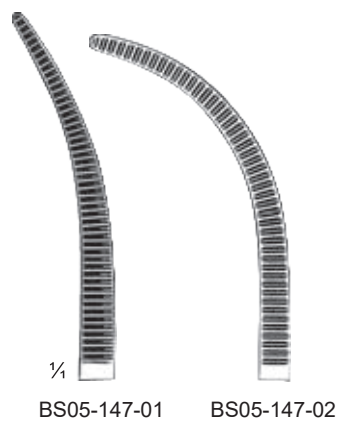

Zenker
30cm/12"

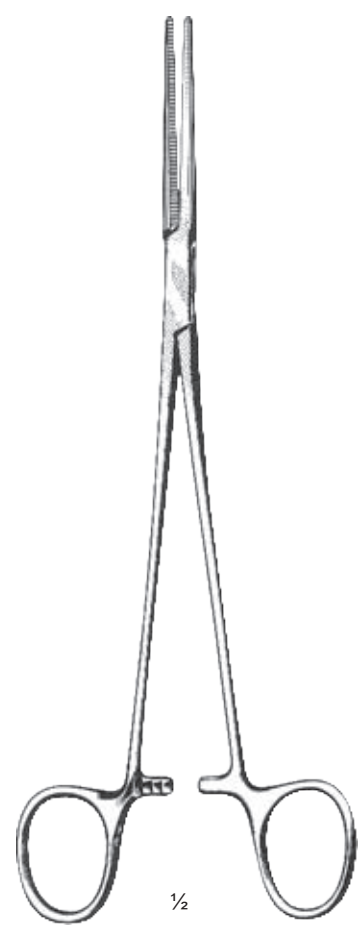

Roberts
24cm/9 1/2"



Toennis

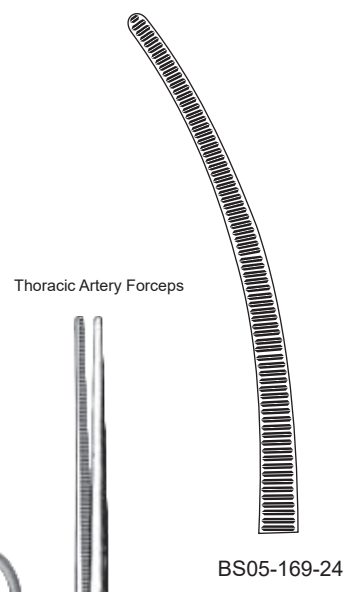
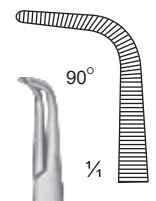
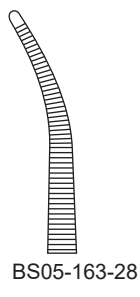
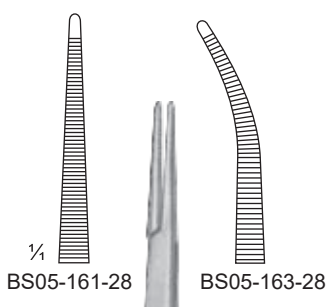

Bridge
28cm/11"

Meeker
BS05-165-28
28cm/11"

Lawrence
BS05-167-28
28cm/11"

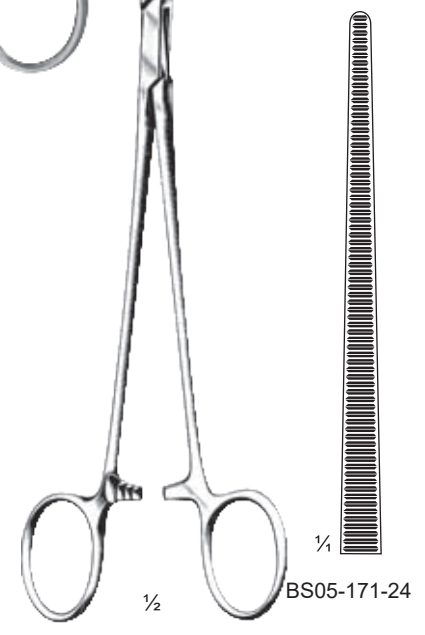

Sarot
24cm/9 1/2"



Dissecting, Hemostatic and Ligature Forceps



Rumel
23cm/9"

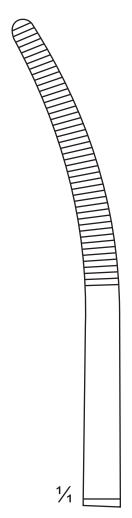

BS05-173-01

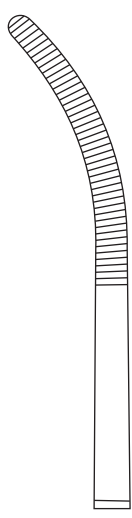

BS05-173-02

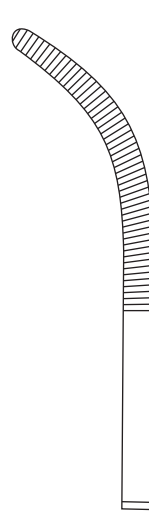

BS05-173-03

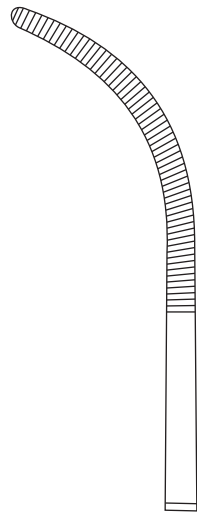

BS05-173-04

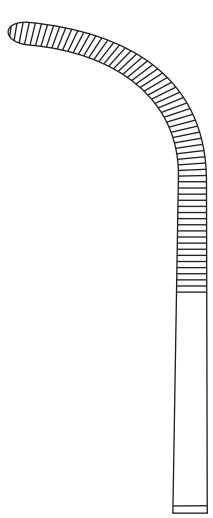

BS05-173-05

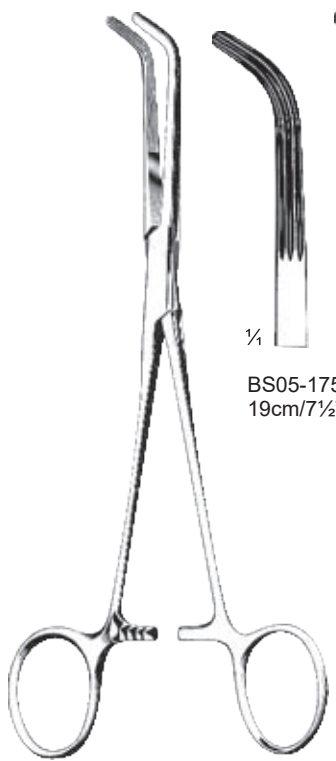

Lahey



BS05-175-19
19cm/7½"



BS05-175-23
23cm/9"



Mixer
BS05-177-23
23cm/9"

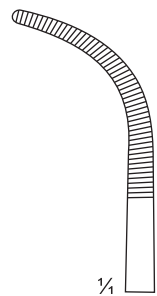

¼



Johns-Hopkins
BS05-179-20
20cm/8"



¼

Dissecting, Hemostatic and Ligature Forceps



Kantrowitz

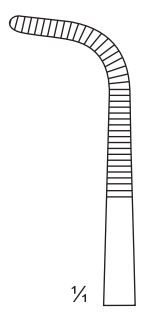

BS05-181-20
20cm/8"

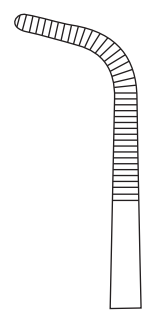

BS05-181-24
24cm/9½"

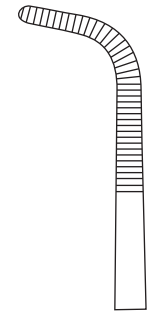

BS05-181-28
28cm/11"



Baby-Adson
BS05-183-18
18cm/7"

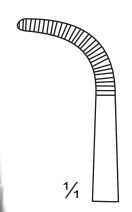

½

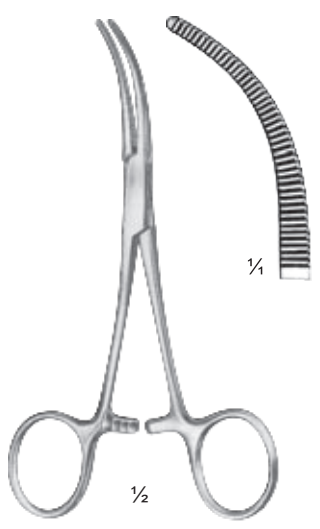

Baby-Overholt
BS05-185-13
3.5cm/5¼"

½



¼

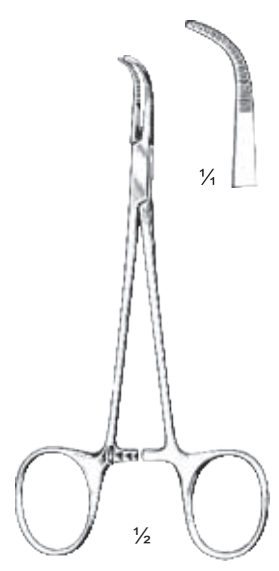

Micro-Adson
BS05-187-13
14cm/5½"

½



¼

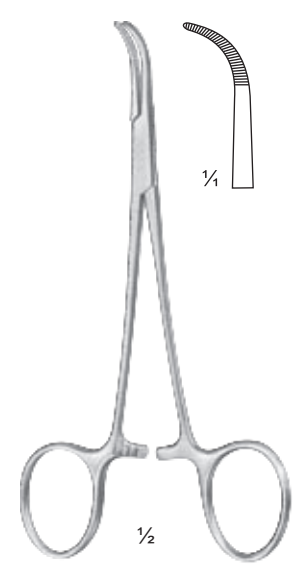

Baby-Adson
BS05-189-14
14cm/5½"

½

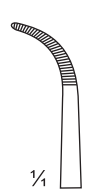

¼

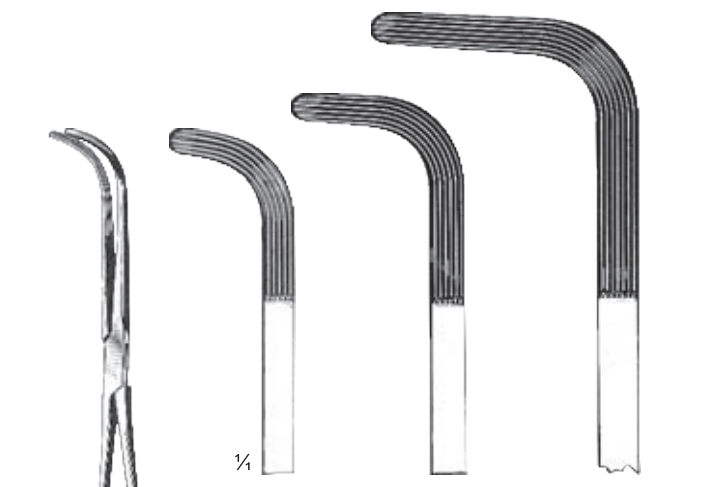

BS05-191-22 22cm/8 3/4"
BS05-191-25 25cm/10"
BS05-191-28 28cm/11"

Also Gall Duct Clamps



Mixer

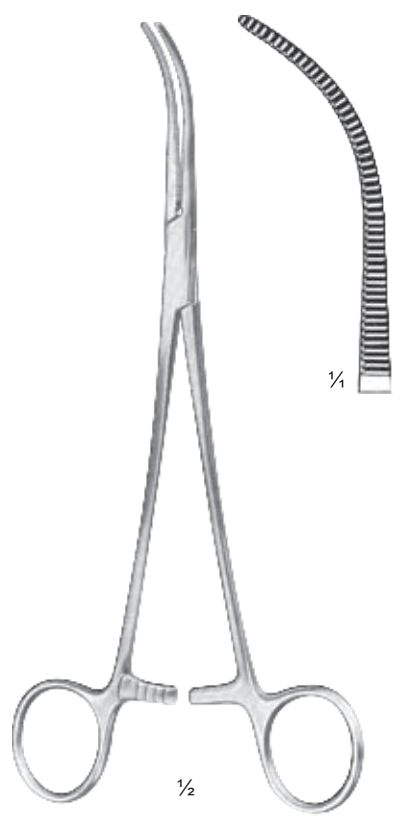

Overholt-Mixer
BS05-193-21
21cm/8 1/4"

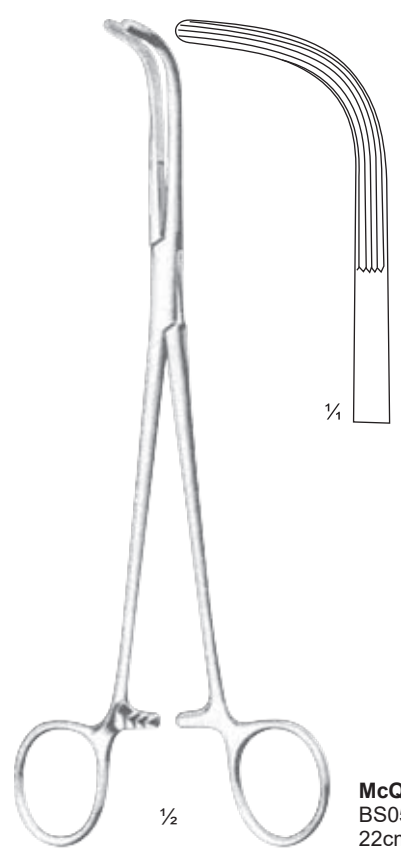

McQuigg-Mixer
BS05-195-22
22cm/8 3/4"

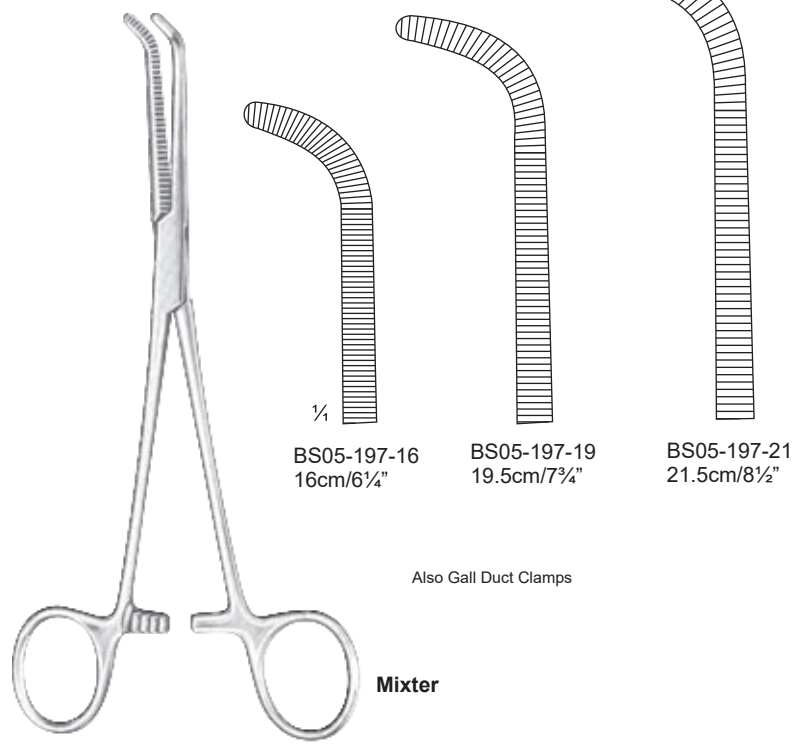

BS05-197-16 16cm/6 1/4"
BS05-197-19 19.5cm/7 3/4"
BS05-197-21 21.5cm/8 1/2"

Also Gall Duct Clamps

Mixer



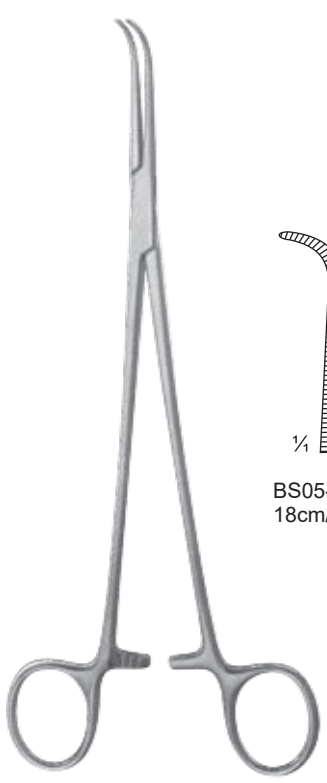

Gemini-Mini (Mixer)

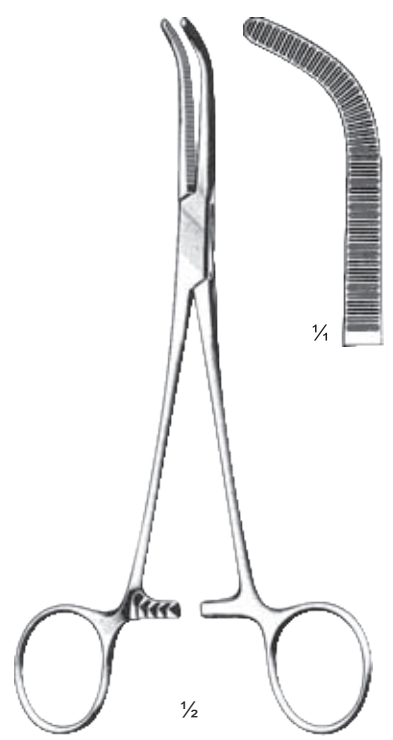
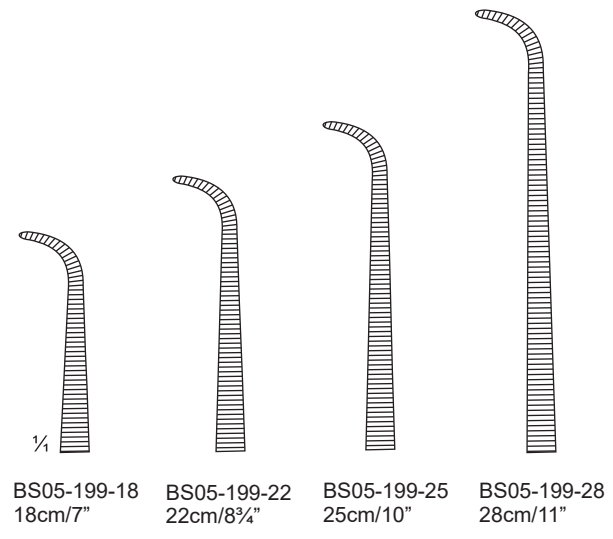

Mixer-O'Shaughnessy
BS05-201-19
19cm/7½"

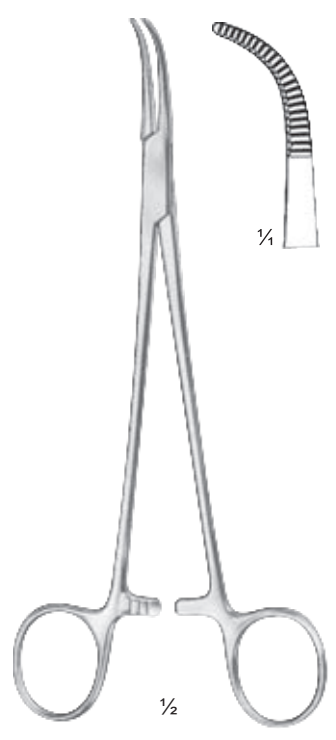

Baby-Mixer
BS05-203-18
18cm/7"

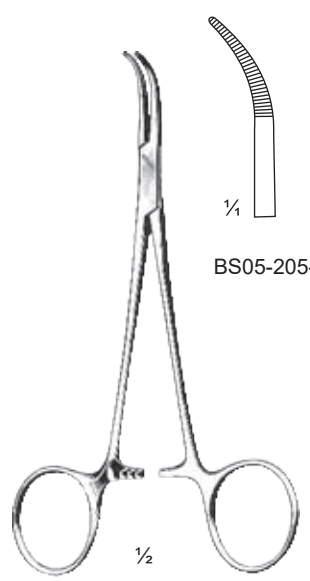

Baby-Mixer
14cm/5½"

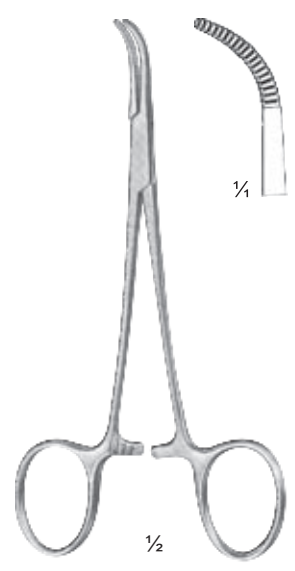
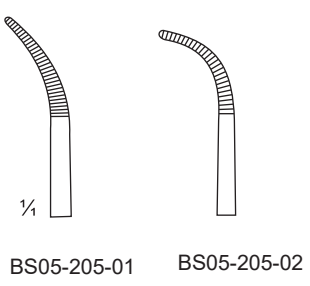

Baby-Mixer
BS05-207-14
14cm/5½"

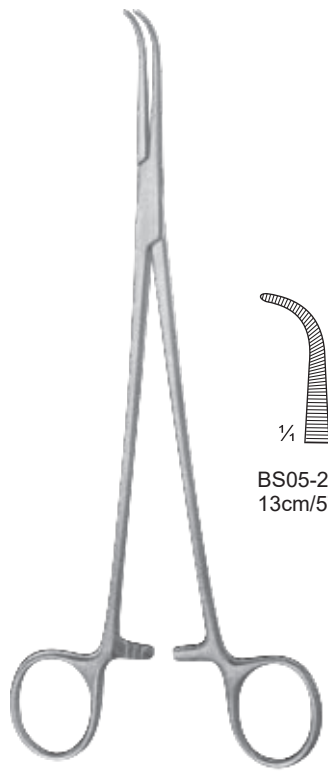

Gemini (DeBaKey-Mixer)

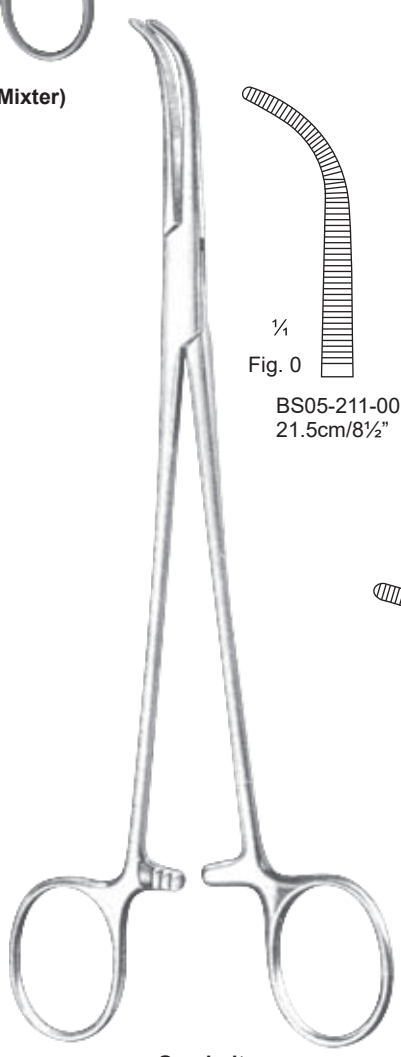
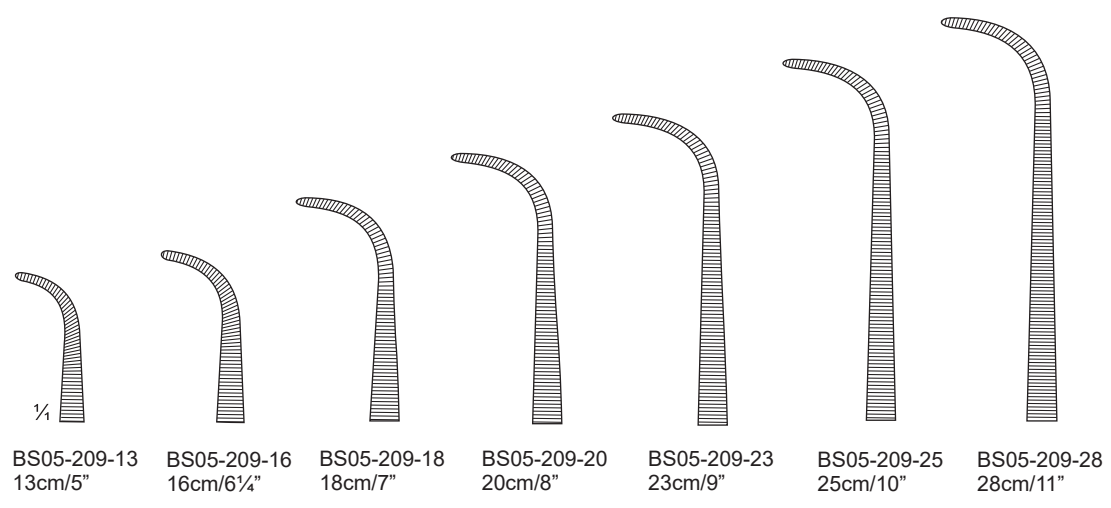

Overholt
delicate pattern

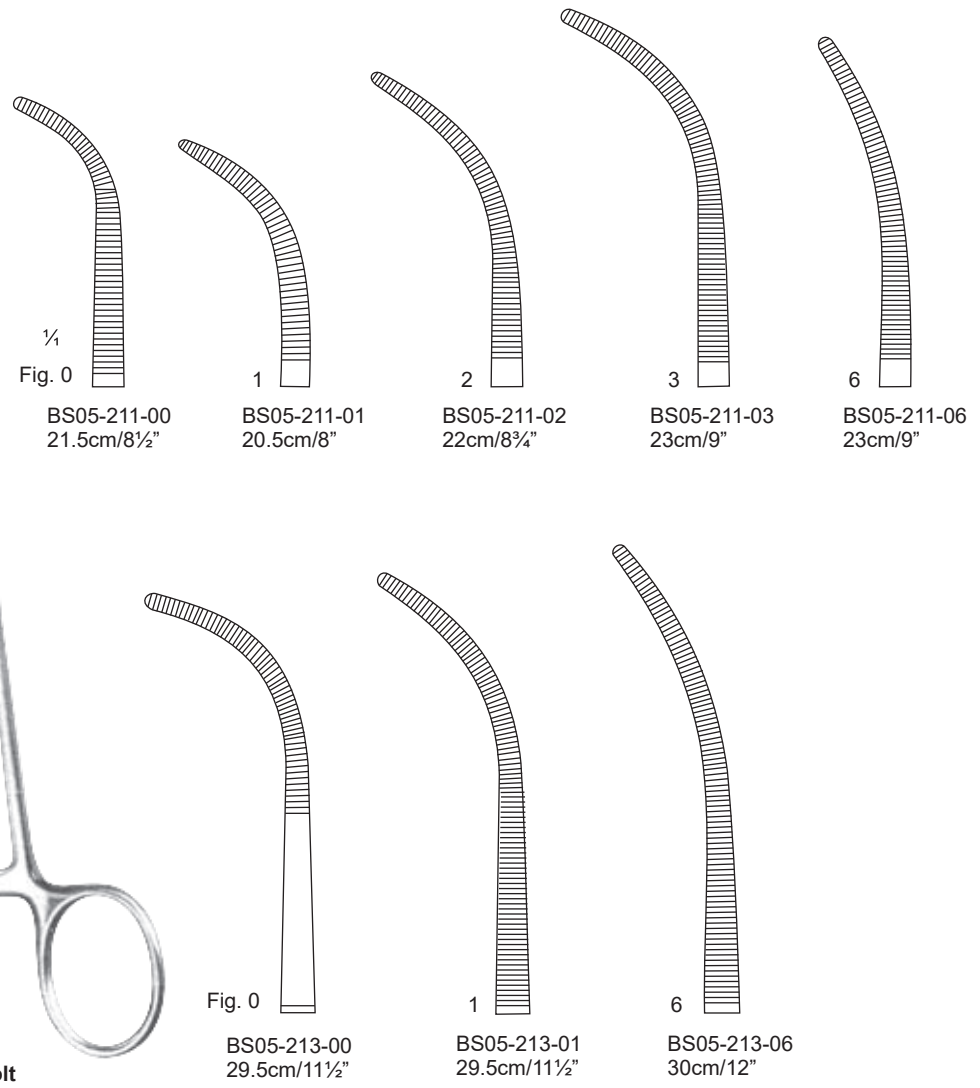



Overholt-Geissendoerfer
BS05-215-00

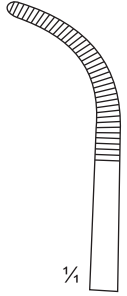
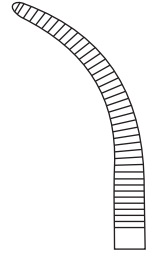
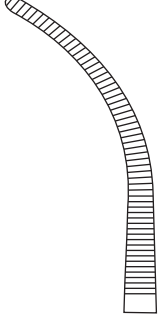
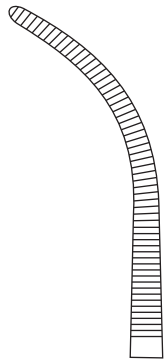
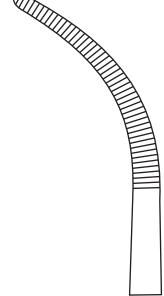
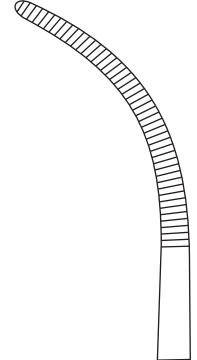
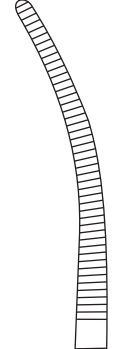

Overholt-Geissendoerfer
BS05-217-00

						
Fig. 0	1	2	3	4	5	6
BS05-215-00 19.5cm/7 $\frac{1}{4}$ "	BS05-215-01 21cm/8 $\frac{1}{4}$ "	BS05-215-02 22.5cm/8 $\frac{3}{4}$ "	BS05-215-03 22.5cm/9"	BS05-215-04 21.5cm/8 $\frac{1}{4}$ "	BS05-215-05 22.5cm/9"	BS05-215-06 22.5cm/9"
BS05-217-00 26cm/10 $\frac{1}{4}$ "	BS05-217-01 27cm/10 $\frac{1}{2}$ "	BS05-217-02 27.5cm/10 $\frac{3}{4}$ "	BS05-217-03 27.5cm/10 $\frac{3}{4}$ "	BS05-217-04 27.5cm/10 $\frac{3}{4}$ "	BS05-217-05 28cm/11"	BS05-217-06 27.5cm/10 $\frac{3}{4}$ "



Dissecting, Hemostatic and Ligature Forceps



Crafoord-Sellors
24cm/9½"

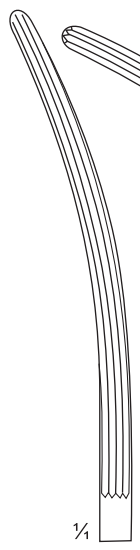

Fig. 1
BS05-219-24

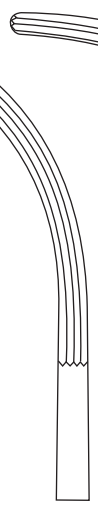

Fig. 2
BS05-219-23

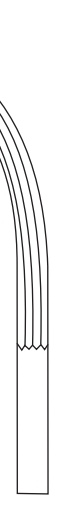
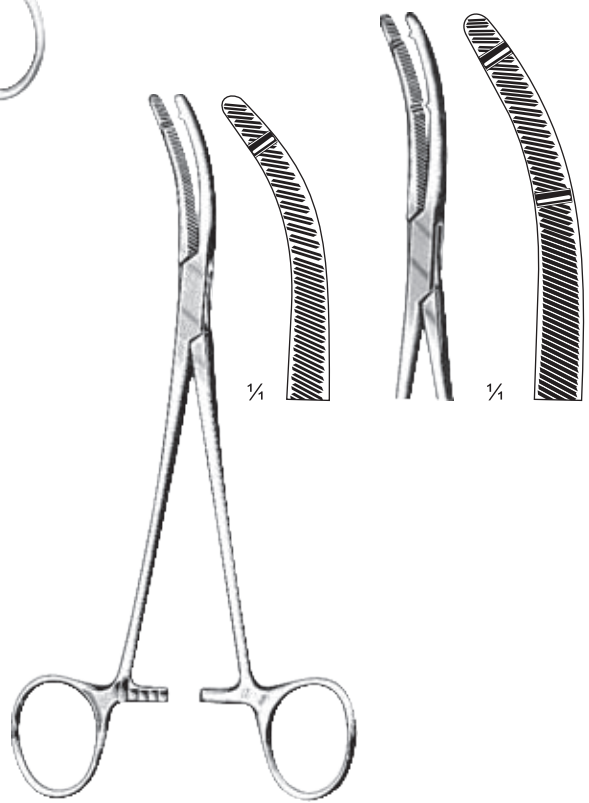
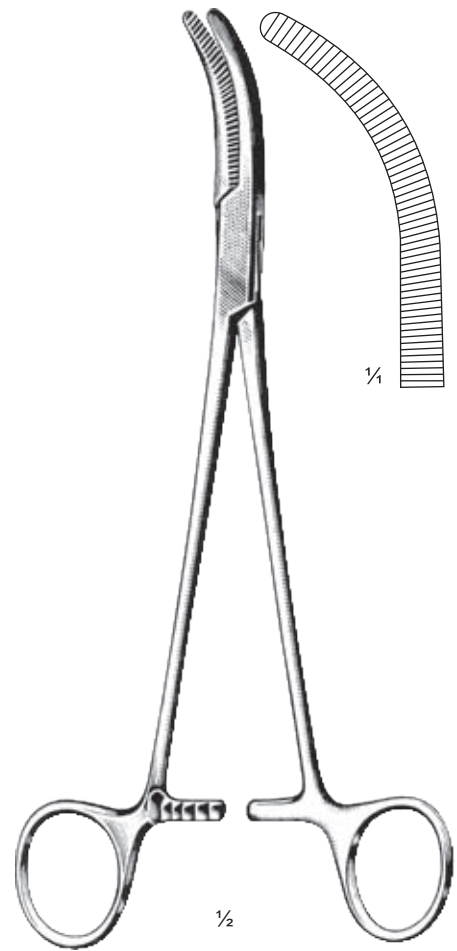

Fig. 3
BS05-219-22



Heaney	cm	in.	
BS05-221-19	19.5	7 ¾	BS05-223-19
BS05-221-21	21.0	8 ¼	BS05-223-21
BS05-221-23	23.0	9	BS05-223-23



Wertheim
BS05-225-25
25 cm/10"



Clamp-Forceps, Hysterectomy and Vaginal Forceps

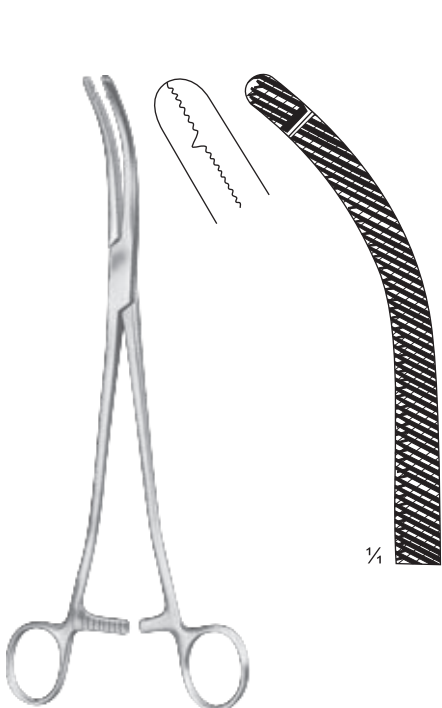

Wiener Modell
BS05-227-20 = 20cm/8"
BS05-227-22 = 22cm/8¾"
BS05-227-25 = 25cm/10"

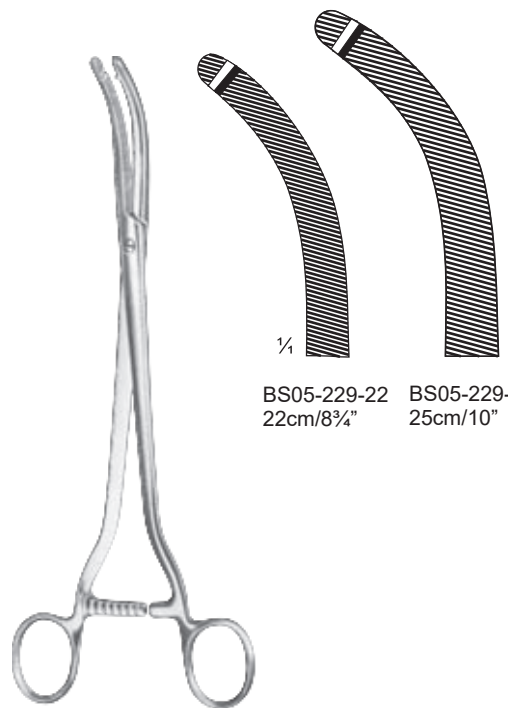

BS05-229-22 22cm/8¾"
BS05-229-25 25cm/10"

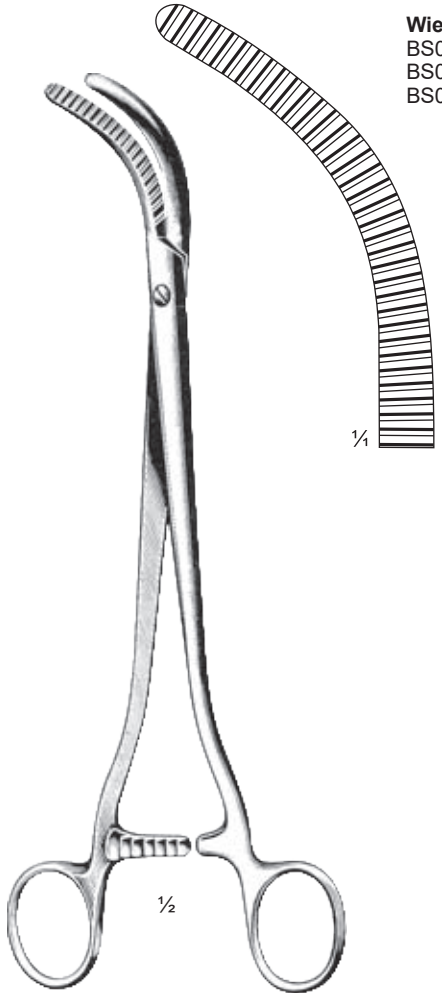

Wertheim
BS05-231-25
25 cm/10"

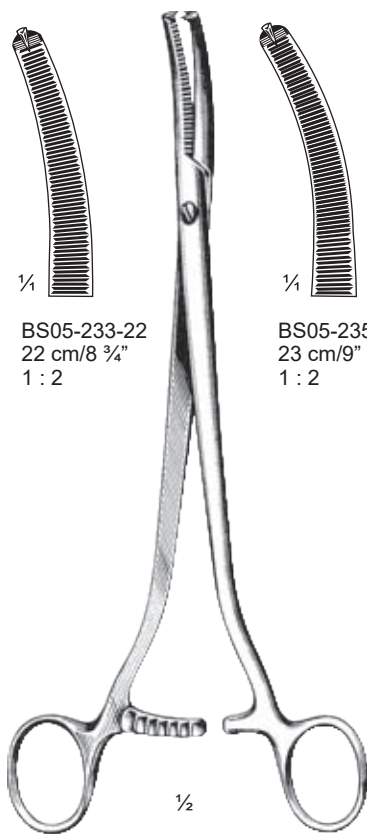

Wertheim
BS05-233-22
slightly curved

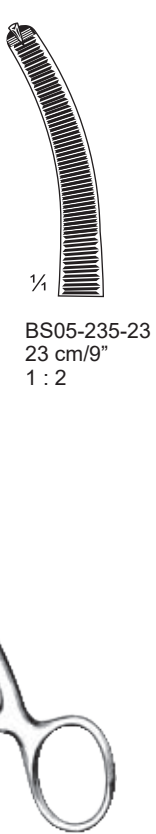

BS05-235-23
more curved

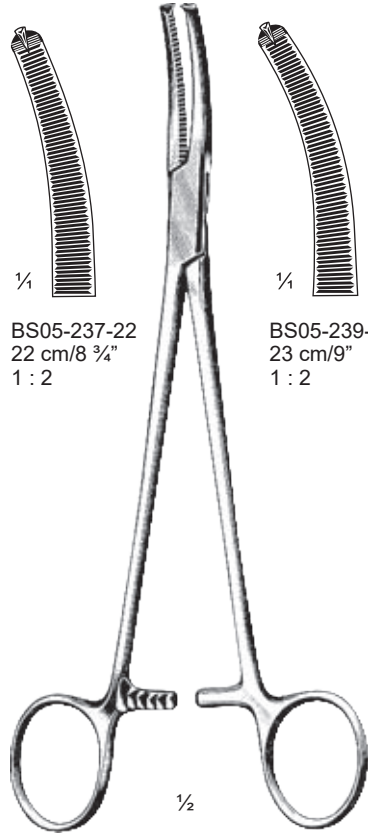

Wertheim
BS05-237-22
slightly curved

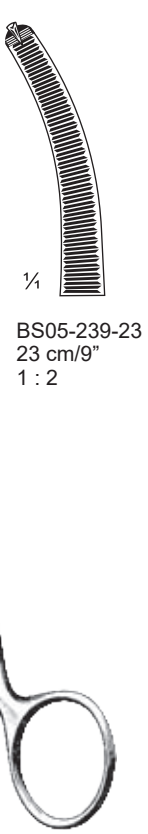

BS05-239-23
more curved



Clamp-Forceps, Hysterectomy and Vaginal Forceps

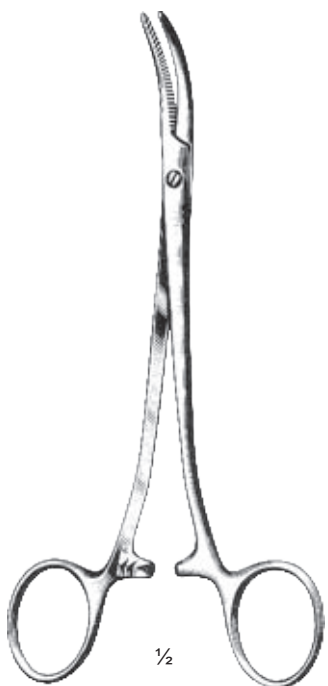

Wertheim
BS05-239-18
18 cm/7"



Phaneuf
21.5cm/8½"

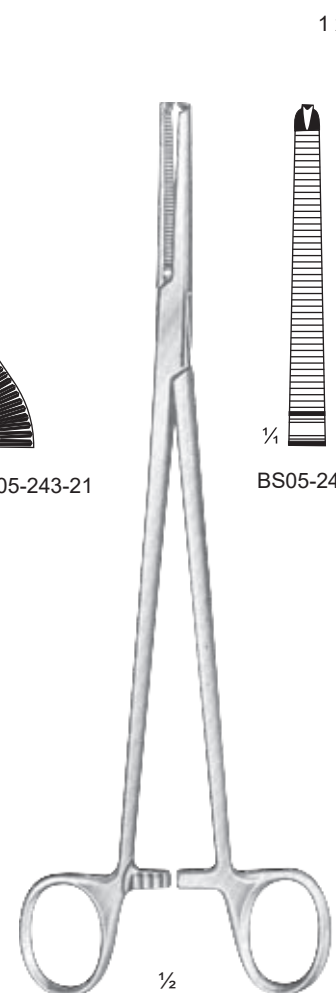
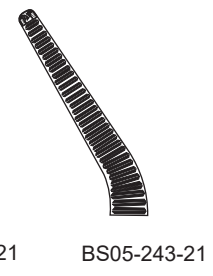

Holzbach
23.5cm/9¼"

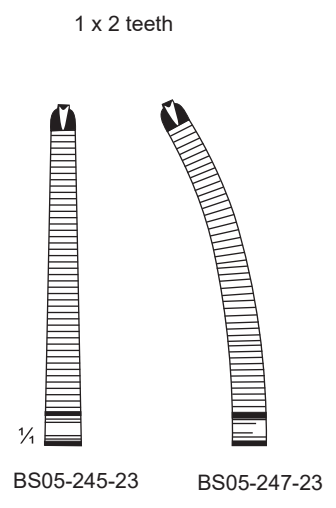

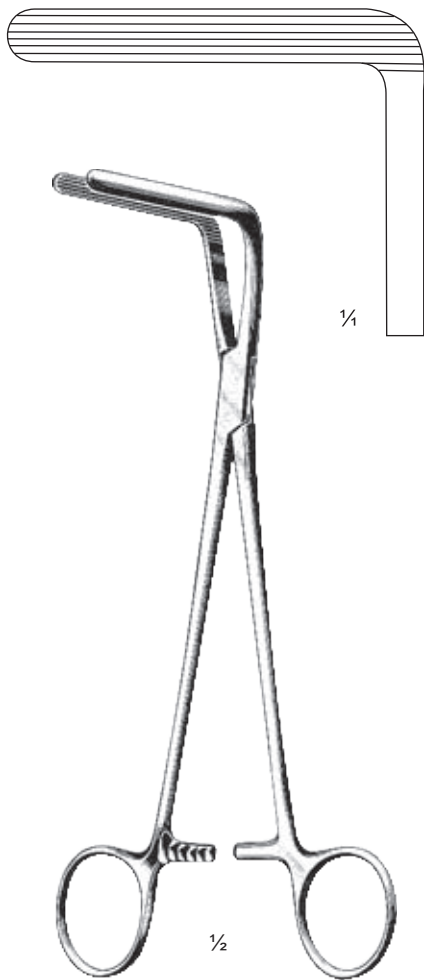

Wertheim-Cullen
BS05-249-21
21.5 cm/8 1/2"

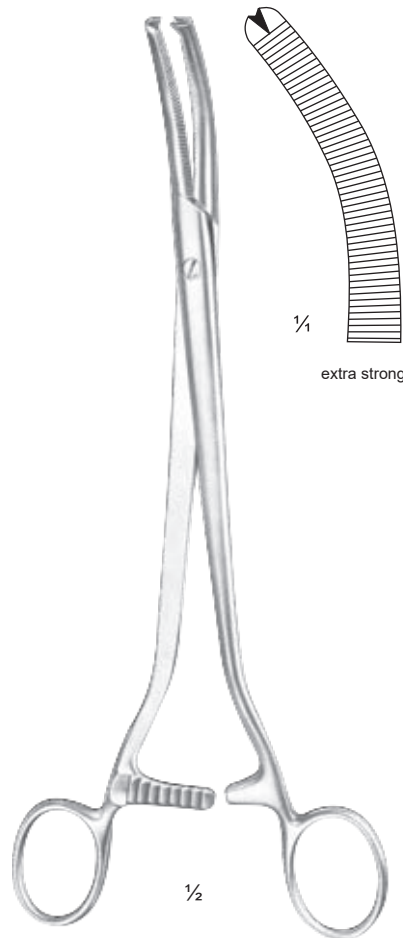

Wertheim
BS05-251-24
24 cm/9 1/2"

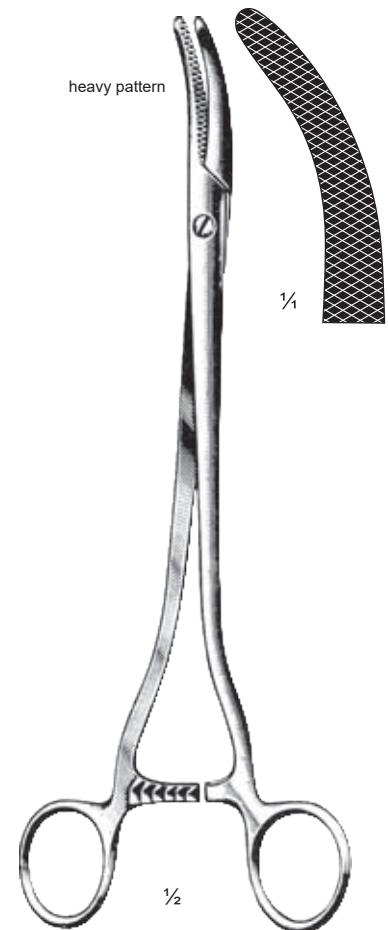

Wertheim
BS05-253-25
25 cm/10"



Wertheim-Martin
23 cm/9 1/4"

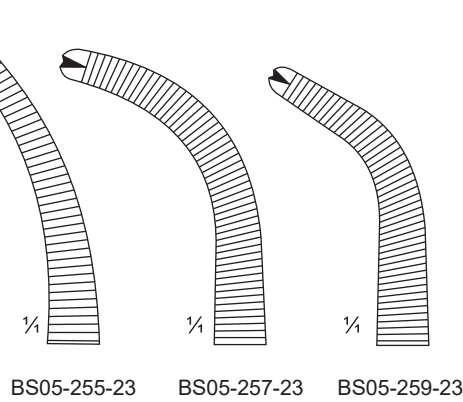

BS05-255-23 BS05-257-23 BS05-259-23

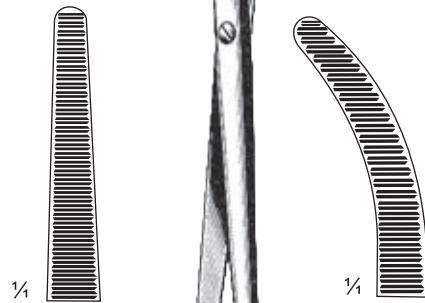

Segond-Landau
BS05-261-24
24 cm/9 1/2"

Segond
BS05-263-24
24 cm/9 1/2"

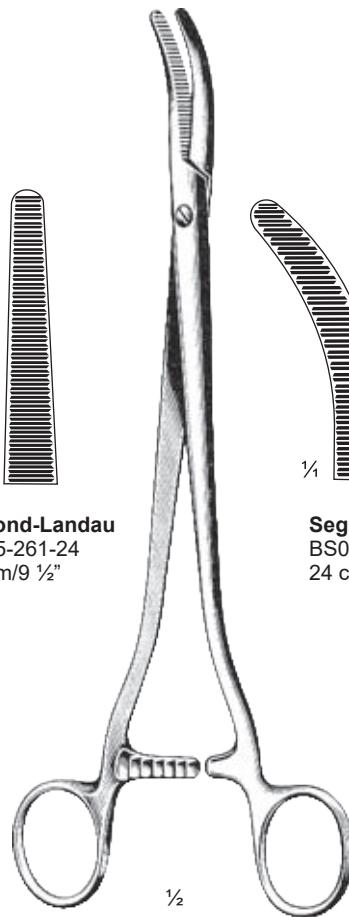

1/2

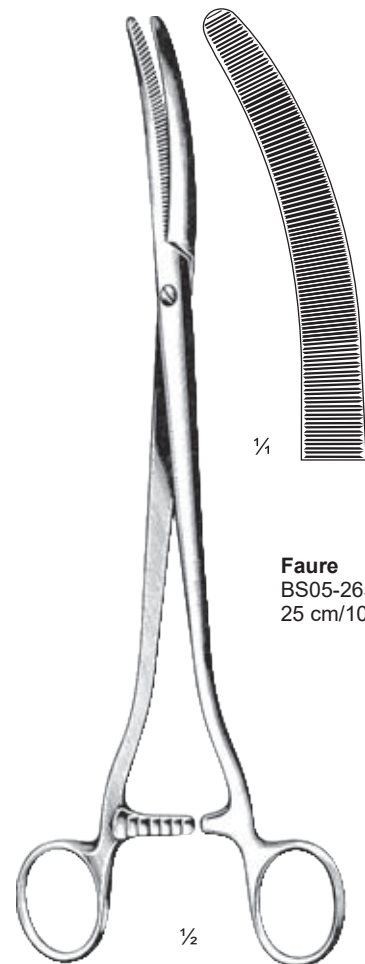

Faure
BS05-265-25
25 cm/10"

1/2

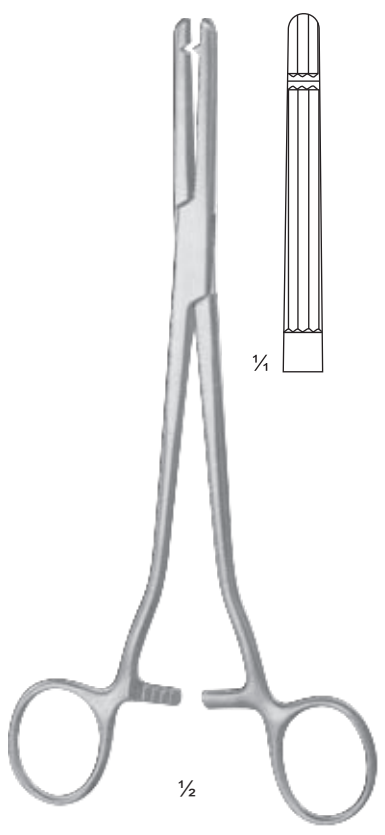

Ballentine
BS05-267-21
21.5cm/8½"

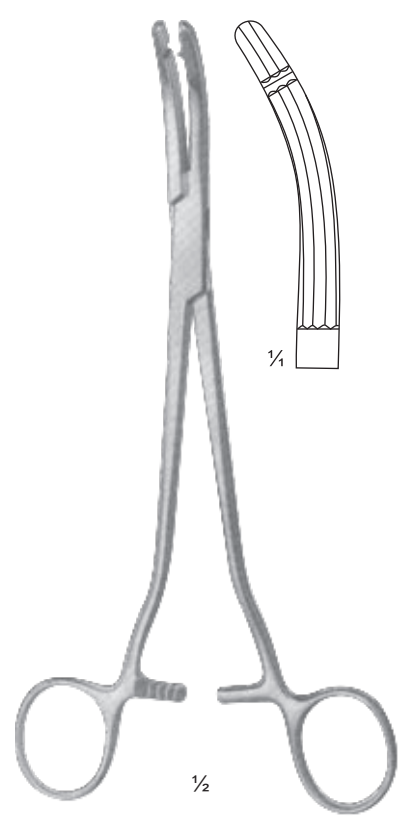

Heaney-Ballentine
BS05-269-21
21.5cm/8½"

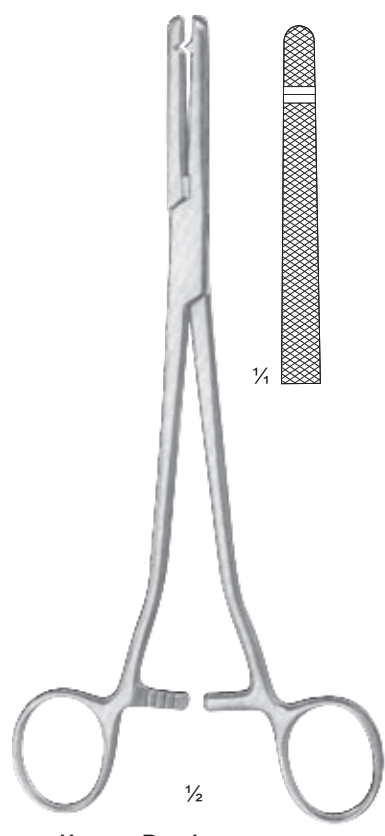

Heaney-Rezek
BS05-271-21
21.5cm/8½"

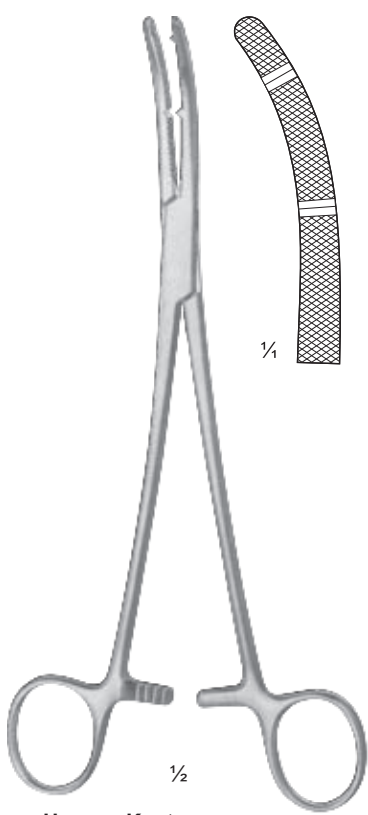

Heaney-Kanter
BS05-273-21
21.5cm/8½"

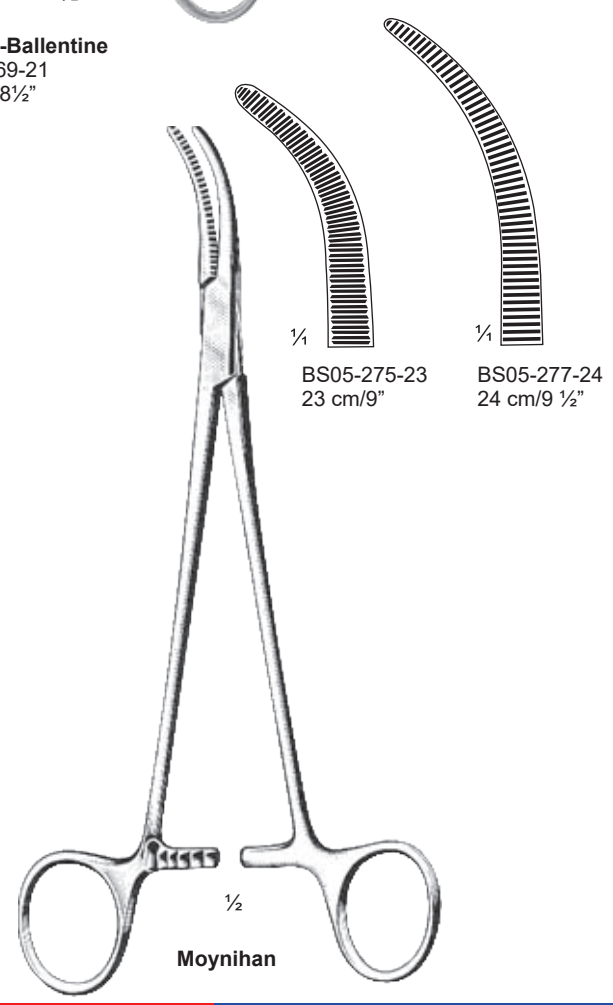

Moynihan

BS05-275-23
23 cm/9"

BS05-277-24
24 cm/9 ½"

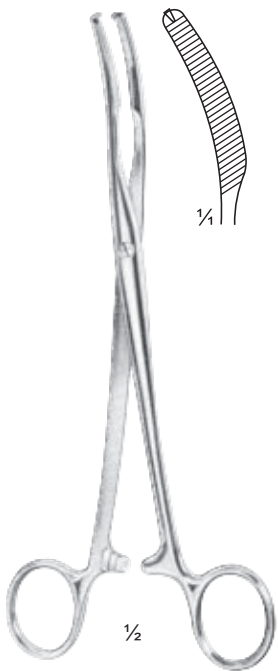

Mikulicz
BS05-279-18
18 cm/7"
1 : 2

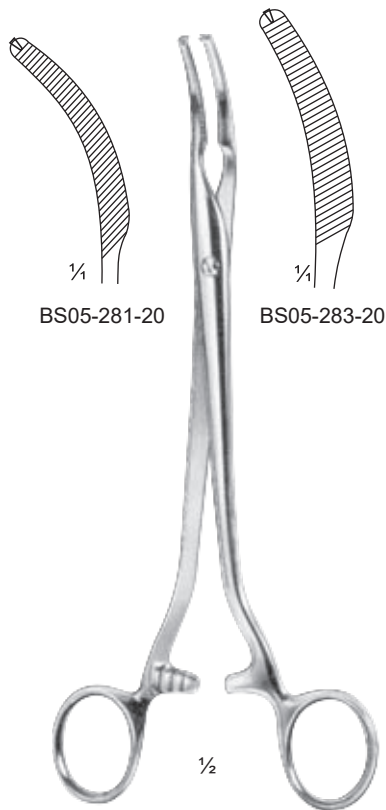

Mikulicz
20 cm/8"
1 : 2

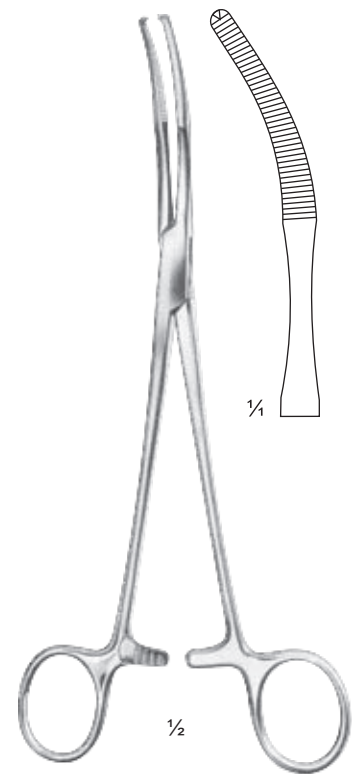

Mikulicz
BS05-285-20
20 cm/8"
1 : 2

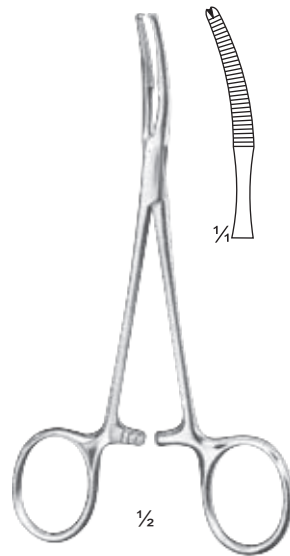

Baby-Mikulicz
BS05-287-14
14 cm/5 1/2"

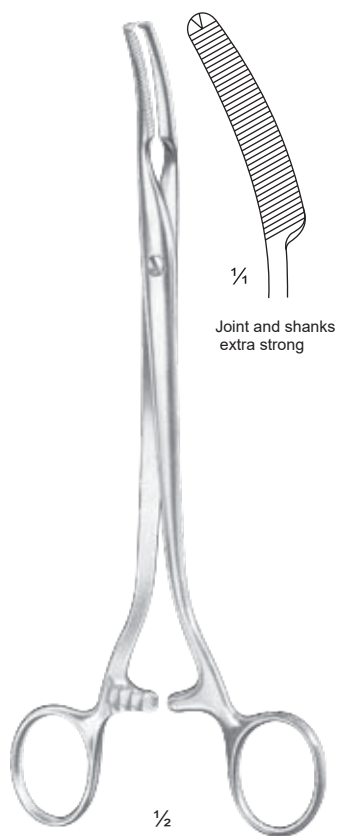

Mikulicz
BS05-289-21
20.0 cm/8"

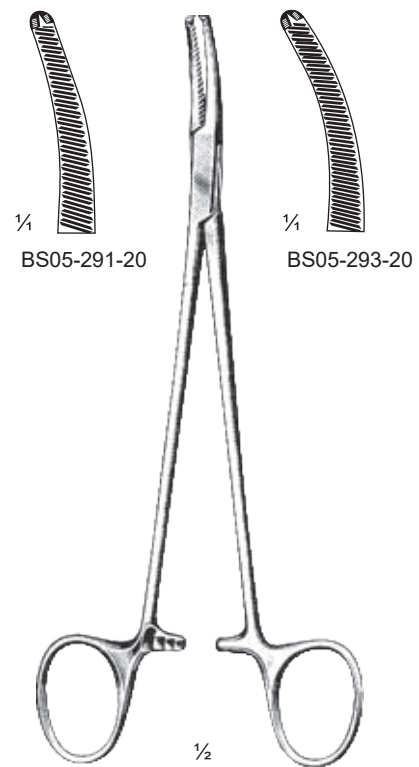

Faure
20 cm/8"
1 : 2

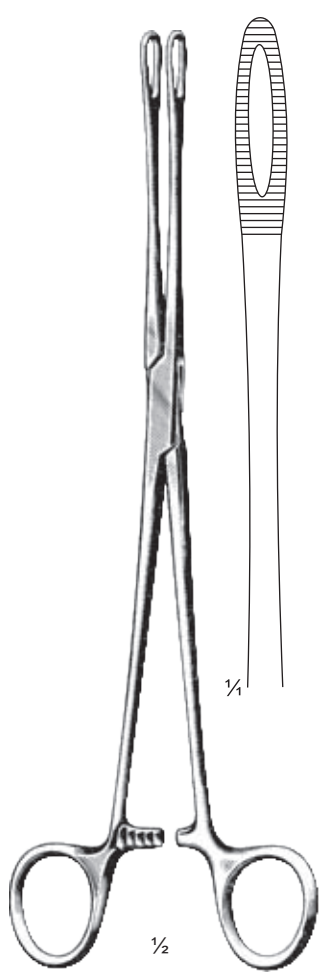

Foerster
25 cm/10"
narrow

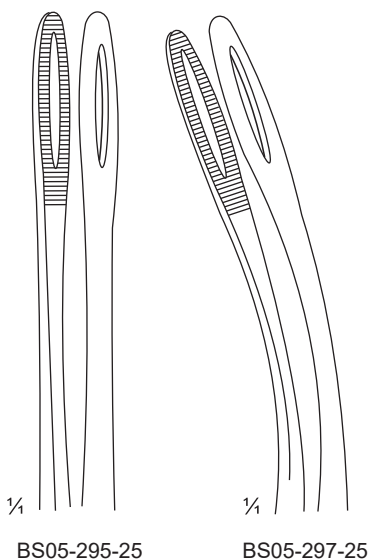

BS05-295-25

BS05-297-25



Ramley
BS05-299-25
25 cm/10"

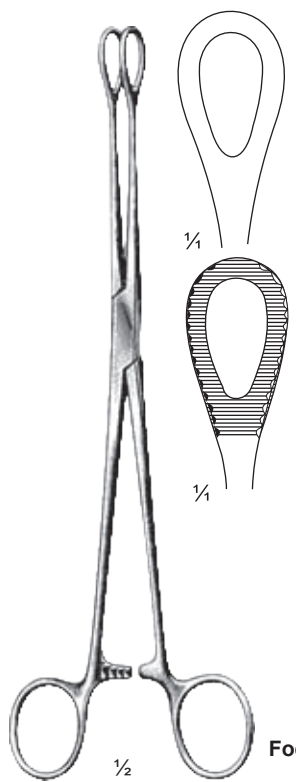

Foerster

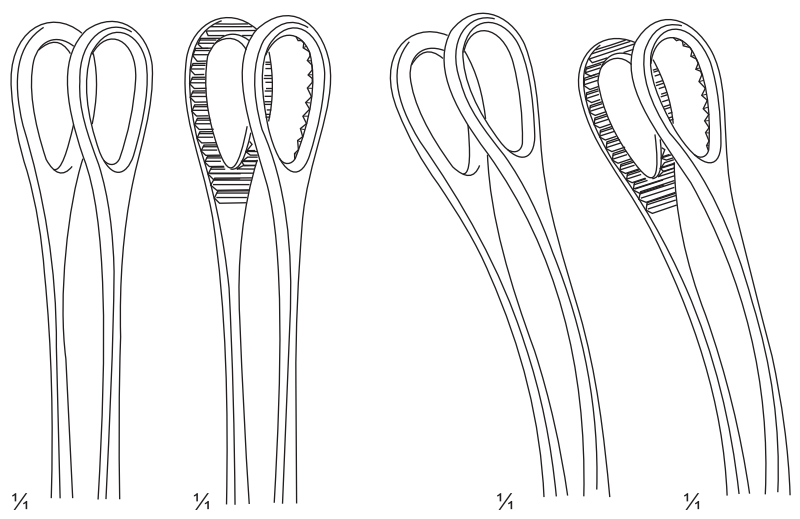

cm	in.		
18.0	7	BS05-303-18	BS05-307-18
20.0	8	BS05-303-20	BS05-307-20
25.0	10	BS05-301-25	BS05-303-25
			BS05-305-25
			BS05-307-25



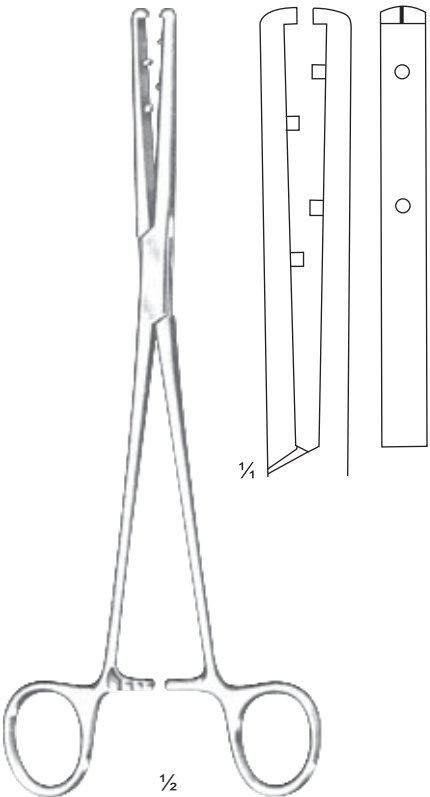

Emmet
BS05-309-21
21cm/8¼"

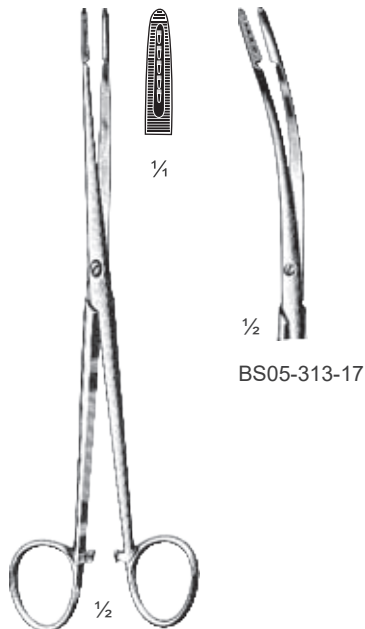

Mod. Martin
BS05-311-17
17 cm/6 ¾"



Duplay
BS05-315-20
20 cm/8"

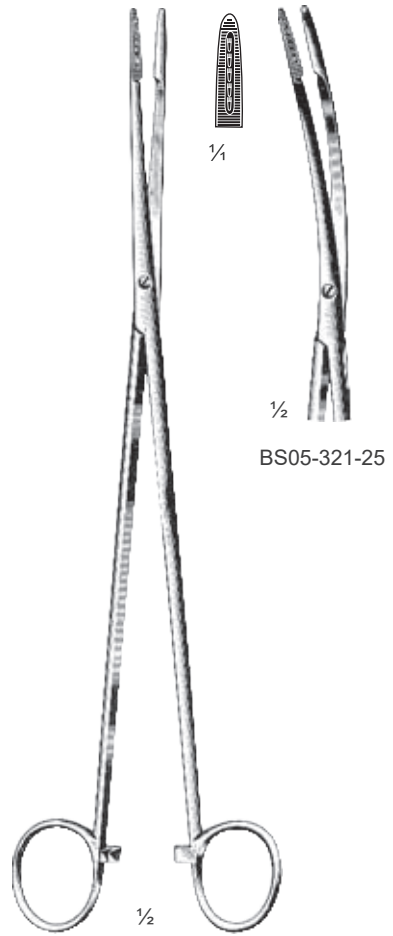

Mod. Martin
BS05-319-25
25.5 cm/10"

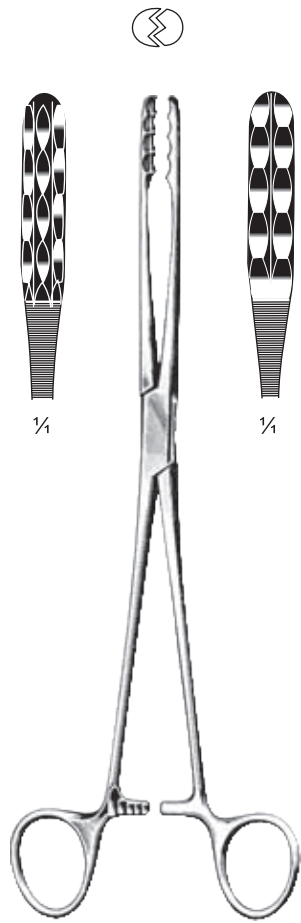

Ulrich
 BS05-323-22 = 22 cm/8 ¾"
 BS05-323-25 = 25 cm/10"
 BS05-323-27 = 27 cm/10 ¾"

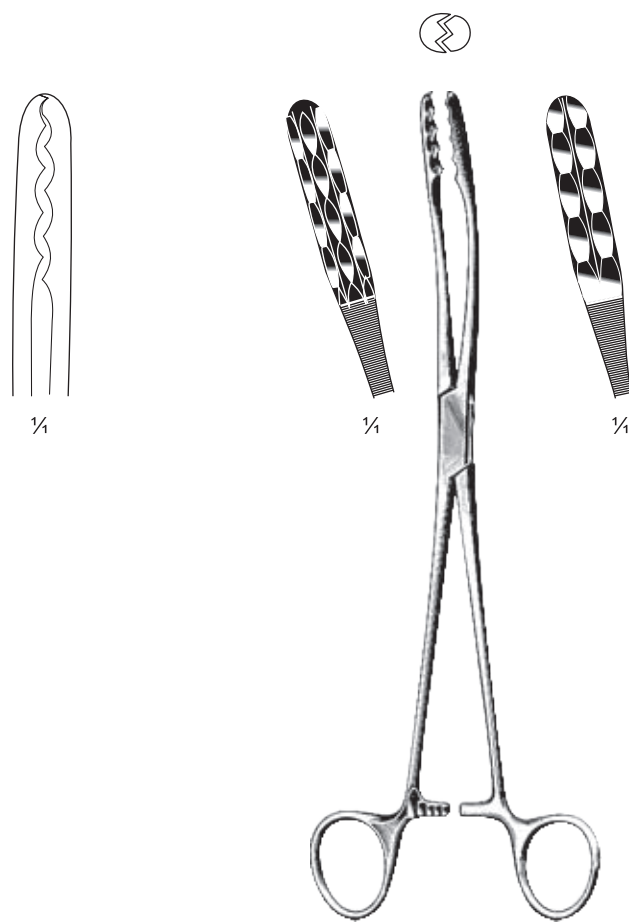

Ulrich
 BS05-325-22 = 22 cm/8 ¾"
 BS05-325-25 = 25 cm/10"
 BS05-325-27 = 27 cm/10 ¾"

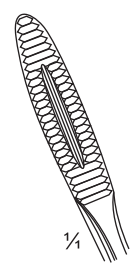
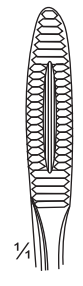
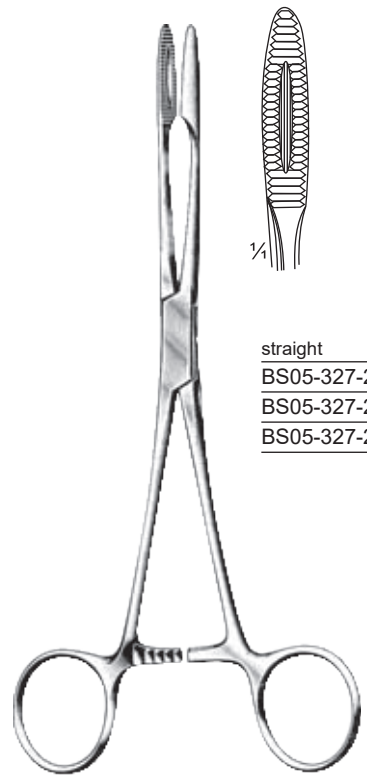

straight	cm	in.	curved
BS05-327-20	20	8	BS05-329-20
BS05-327-22	22	8 3/4	BS05-329-22
BS05-327-25	25	10	BS05-329-25

Gross-Maier
20 cm/8"

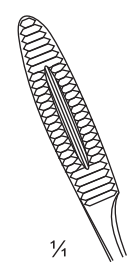
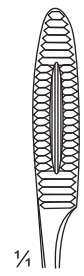
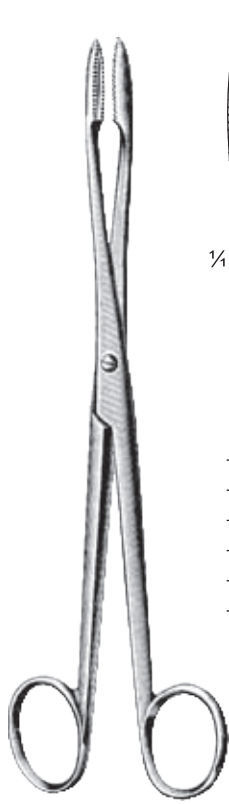

without ratchet

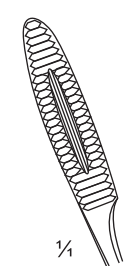
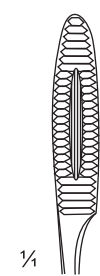

with ratchet

straight	curved	cm	in.	straight	curved
-	-	14.5	5 1/2	BS05-335-14	BS05-337-14
BS05-331-16	BS05-333-16	16	6 1/4	BS05-335-16	BS05-337-16
BS05-331-18	BS05-333-18	18	7	BS05-335-18	BS05-337-18
BS05-331-20	BS05-333-20	20	8	BS05-335-20	BS05-337-20
BS05-331-25	BS05-333-25	25	10	BS05-335-25	BS05-337-25

Gross-Maier

Gross-Maier

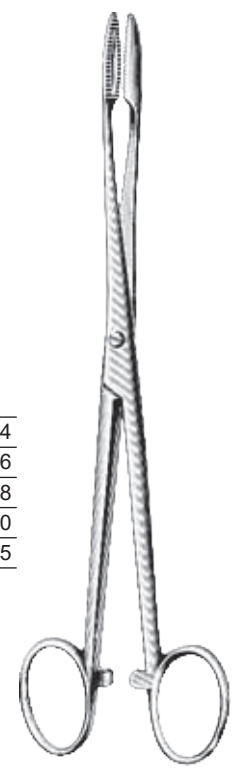

Polypus, Dressing and Cotton Swab Forceps, Foreign Body Forceps

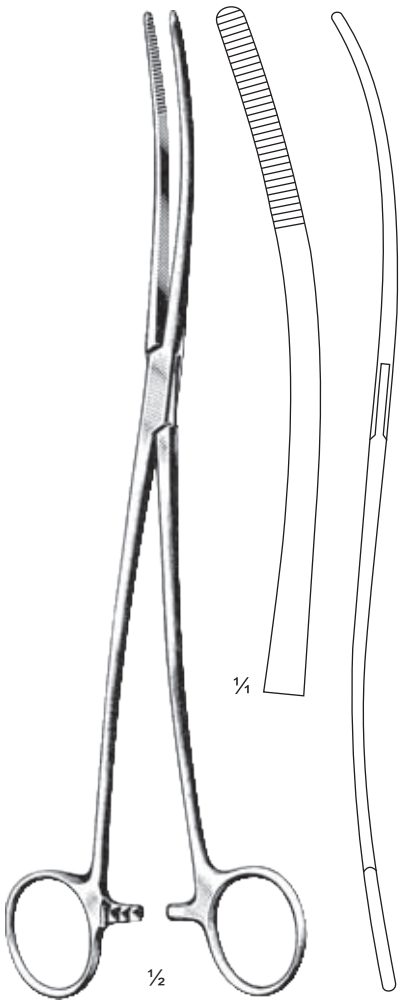

Bozemann
BS05-339-26
26 cm/10 1/4"

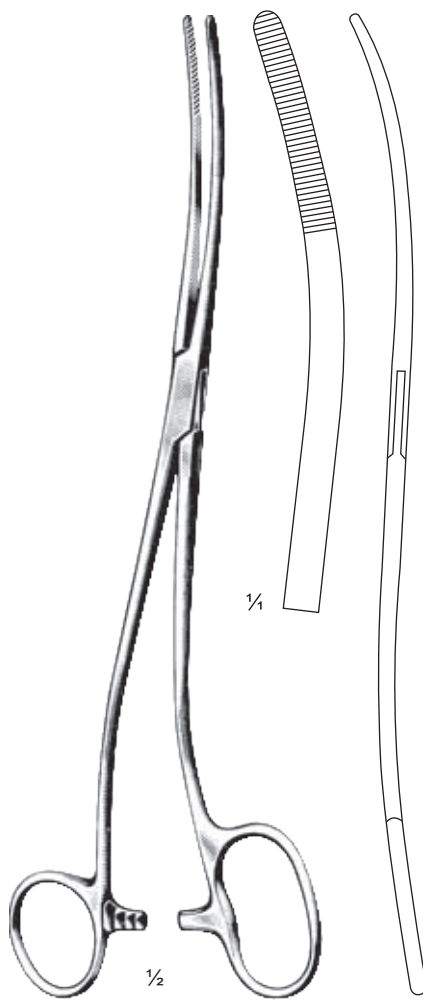

Bozemann-Douglas
BS05-341-26
26 cm/10 1/4"

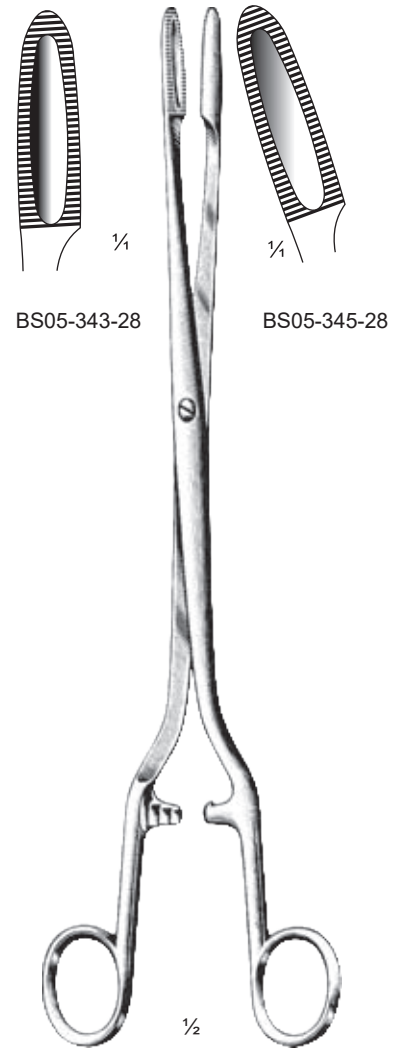

Sims-Maier
28 cm/11"

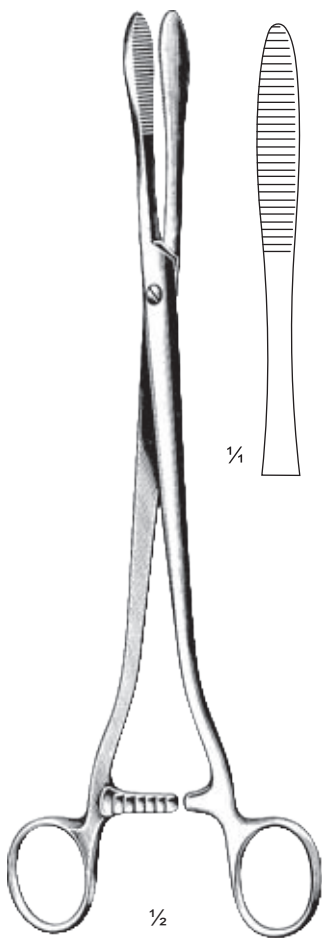

Collin
BS05-347-25
25 cm/10"



Pelkmann
BS05-349-25
25 cm/10"

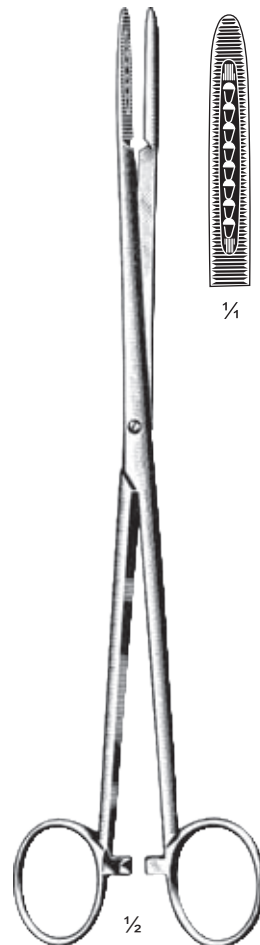

Maier
BS05-353-25
25 cm/10"

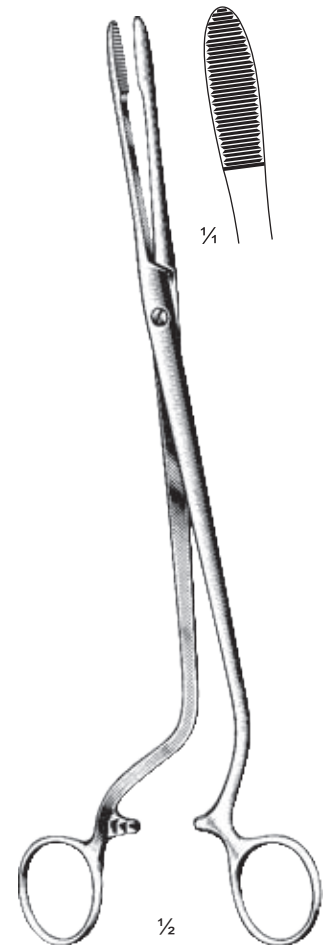

Cheron
BS05-355-25
25 cm/10"

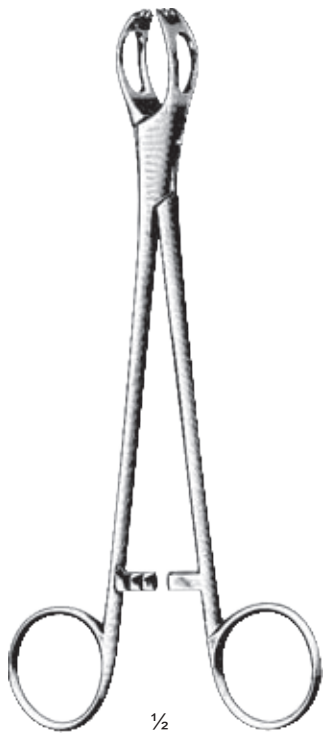

Lane
BS05-357-20
20 cm/8"



Roeder
BS05-359-13 = 13 cm/5"
BS05-359-15 = 15 cm/6"

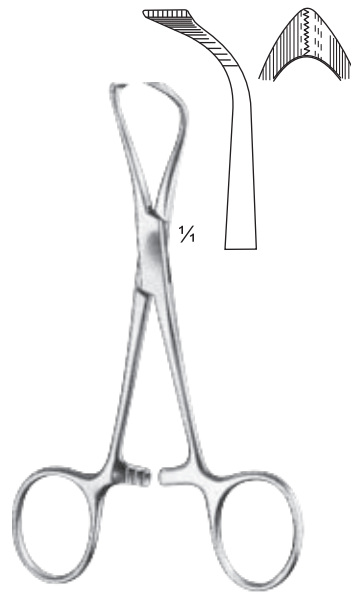

Lorna
BS05-361-10 = 10 cm/4"
BS05-361-13 = 13 cm/5"



Bernhard
BS05-363-16
16 cm/6 1/2"



BS05-365-11 = 11 cm/4 1/2"
BS05-365-13 = 13 cm/5"
delicate pattern



BS05-367-11
11 cm/4 1/2"
with Clip for Tubing or Cable

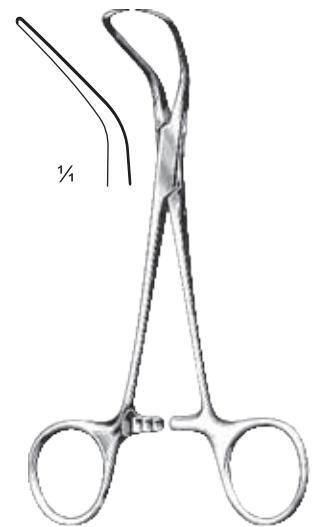

Backhaus
BS05-369-08 = 8 cm/3 1/4"
BS05-369-11 = 11 cm/4 1/2"
BS05-369-13 = 13 cm/5"
BS05-369-15 = 15 cm/6"

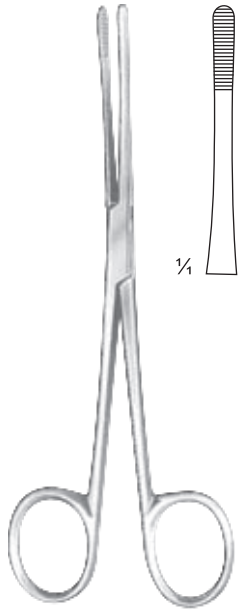

Lister
 BS05-371-13 = 13cm/5"
 BS05-371-15 = 15cm/6"
 BS05-371-18 = 18cm/7"

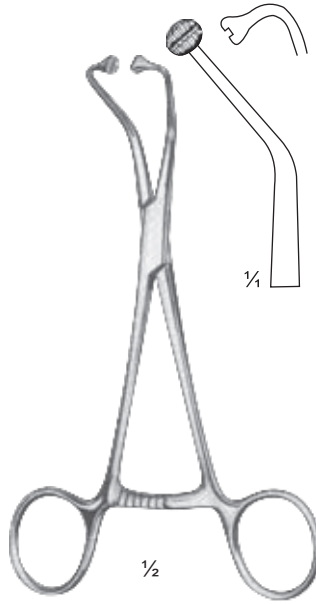

Peers
 BS05-373-14
 14.5cm/ 5 3/4"

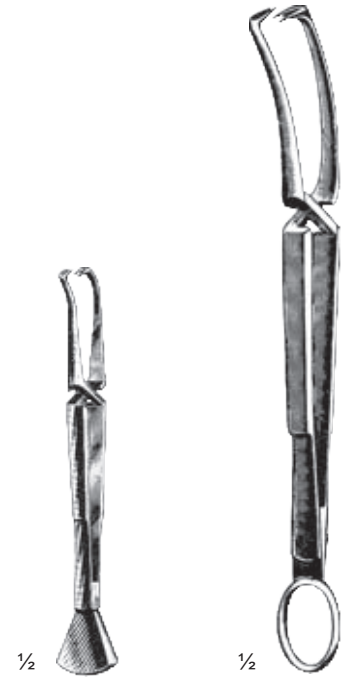

Doyen
 BS05-375-11
 11 cm/4 1/2"

Doyen
 BS05-377-18
 18 cm/7"



Schaedel
 BS05-379-09
 9 cm/3 1/2"



Engl. Modell
 BS05-381-09
 9 cm/3 1/2"



Jones
 BS05-383-05 = 5 cm/2"
 BS05-383-09 = 9 cm/3 1/2"



Jones-Martin
 BS05-385-09
 9 cm/3 1/2"
 with Clip for
 Tubing or Cable

Tendon Interlacing Forceps

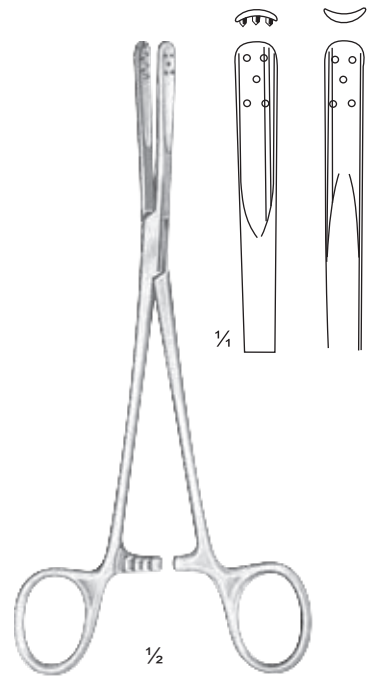

Brand
BS05-387-15
15.5cm/5 3/4"

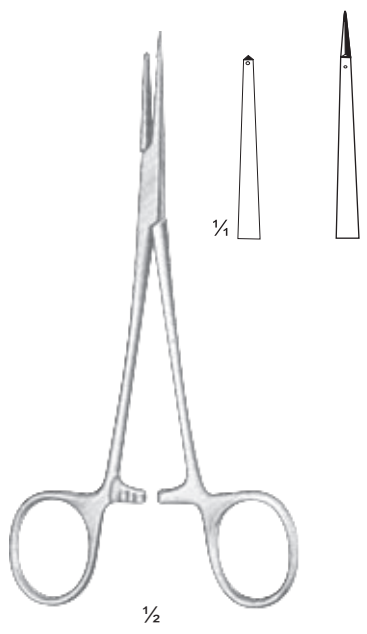

BS05-389-15
15cm/6"

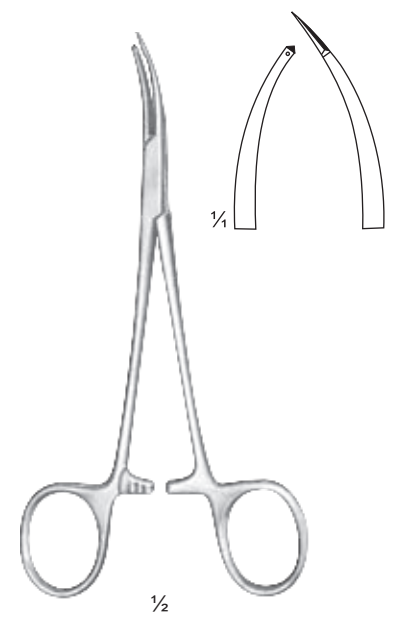

BS05-391-15
15cm/6"

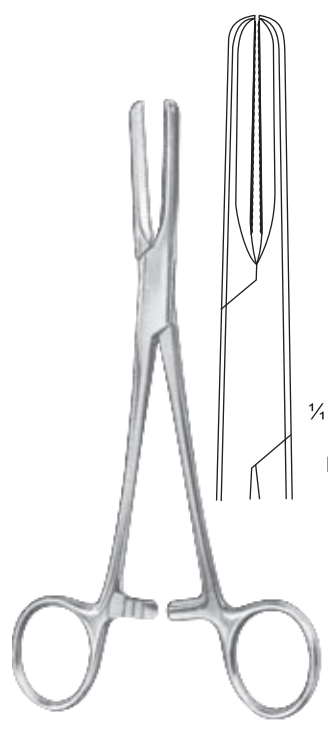

BS05-393-15
15cm/6"

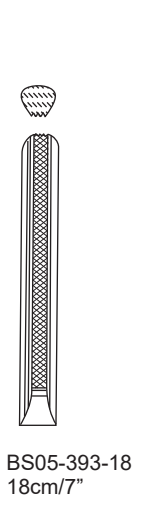

BS05-393-18
18cm/7"

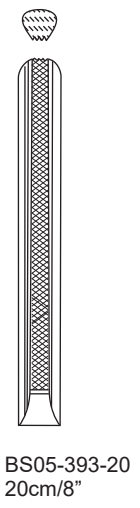

BS05-393-20
20cm/8"

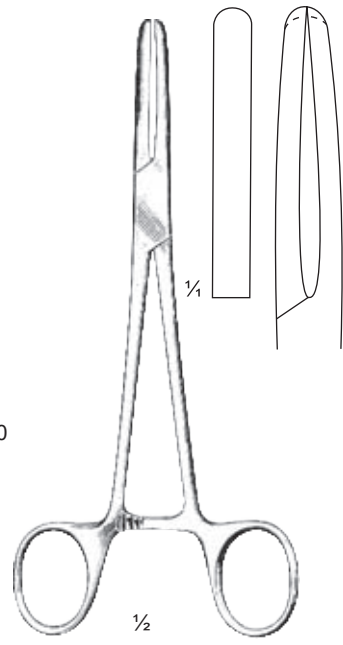

Presbyterian-Hospital
BS05-395-16
16.5cm/6 1/2"

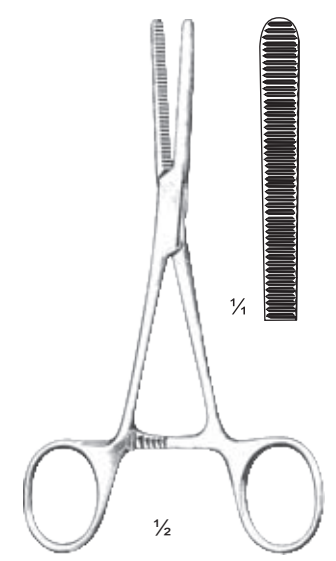

Mod. Klinikum Berlin
BS05-397-14
14.5cm/5 3/4"