



# Probes, Trocars, Suction tubes





cm	in.	Stacke	Doyen	Nelaton	
10.5	4 ¼	BS07-001-10			
11.5	4 ½		BS07-005-11		
13.0	5		BS07-005-13	BS07-007-13	
14.0	5 ½			BS07-009-14	
14.5	5 ½	BS07-003-14	BS07-005-14	BS07-007-14	
16.0	6 ¼	BS07-003-16	BS07-005-16	BS07-007-16	BS07-011-16
18.0	7		BS07-005-18	BS07-007-18	
20.0	8		BS07-005-20		



cm	in.	2 mm ø	1 mm ø	2 mm ø	2 mm ø	2 mm ø
11.5	4 ½	BS07-013-11	BS07-015-11		BS07-019-11	
13.0	5	BS07-013-13	BS07-015-13	BS07-017-13	BS07-019-13	
14.5	5 ½	BS07-013-14	BS07-015-14	BS07-017-14	BS07-019-14	BS07-021-14
16.0	6 ¼	BS07-013-16	BS07-015-16	BS07-017-16	BS07-019-16	
18.0	7	BS07-013-18	BS07-015-18		BS07-019-18	BS07-021-18
20.0	8	BS07-013-20	BS07-015-20		BS07-019-20	
25.0	10	BS07-013-25			BS07-019-25	

**Fish**  
BS07-023-13

**Kronecker**  
BS07-025-15

**Johns-Hopkins**  
BS07-025-15

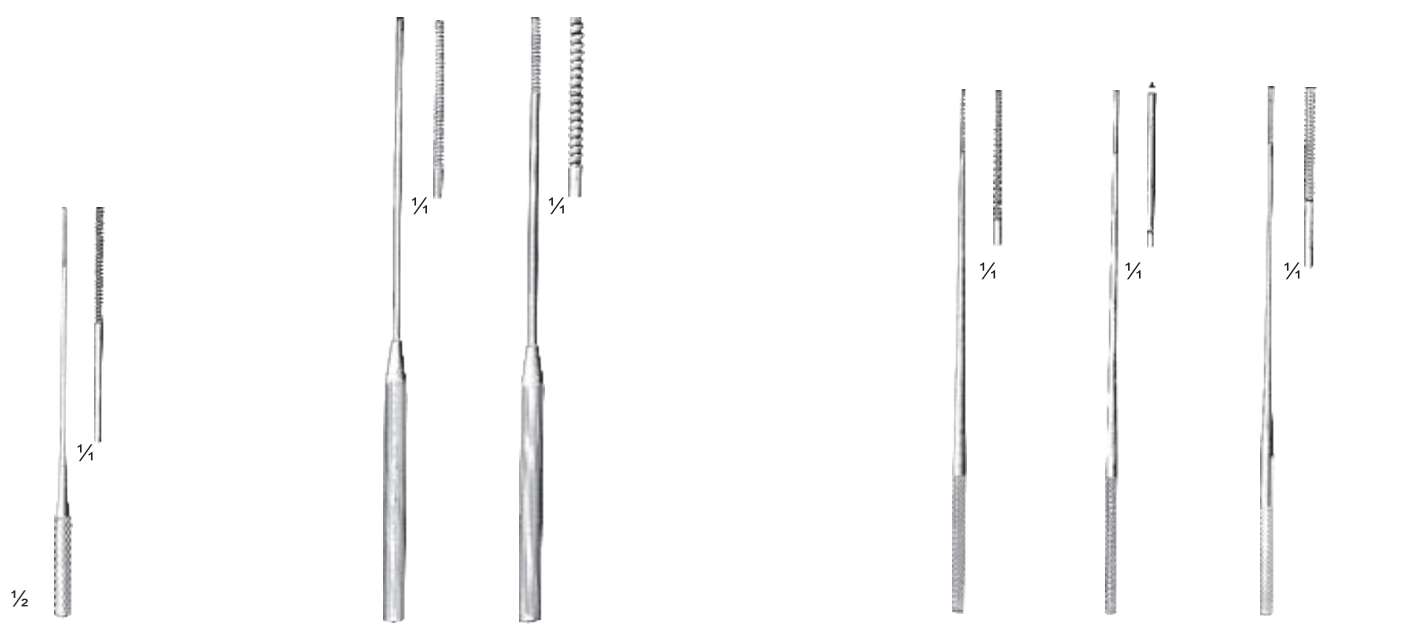
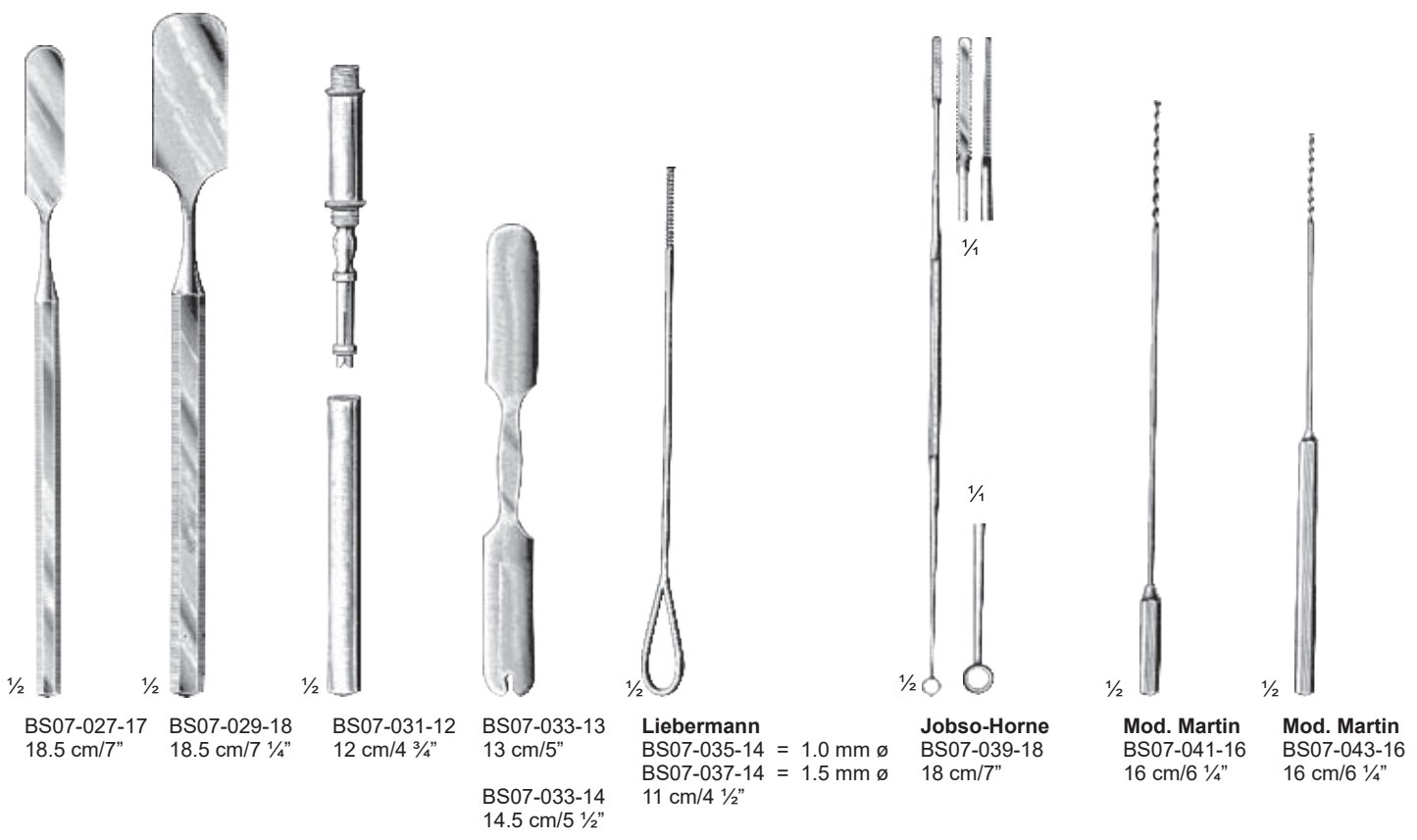

**Ziegler**  
 BS07-045-11  
 11 cm/4 1/2"  
 1.3 mm ø

		Universal	
cm	in.	1.2 mm ø	1.7 mm ø
12.5	5	BS07-047-12	BS07-049-12
16	6 1/4	BS07-047-16	BS07-049-16

			Farrell (Lathbury-Uebe)		
cm	in.	mm ø			
12	4 3/4	0.9	BS07-051-12	BS07-053-12	BS07-055-12
14	5 1/2	0.9	BS07-051-14	BS07-053-14	BS07-055-14
16 1/2	6 1/2	1.1	BS07-051-16	BS07-053-16	BS07-055-16
18	7	1.2	BS07-051-18	BS07-053-18	BS07-055-18
23	9	1.3	BS07-051-23	BS07-053-23	BS07-055-23

Cotton Applicators, Sponge Holders, Cotton Carrier for Rectoscopes

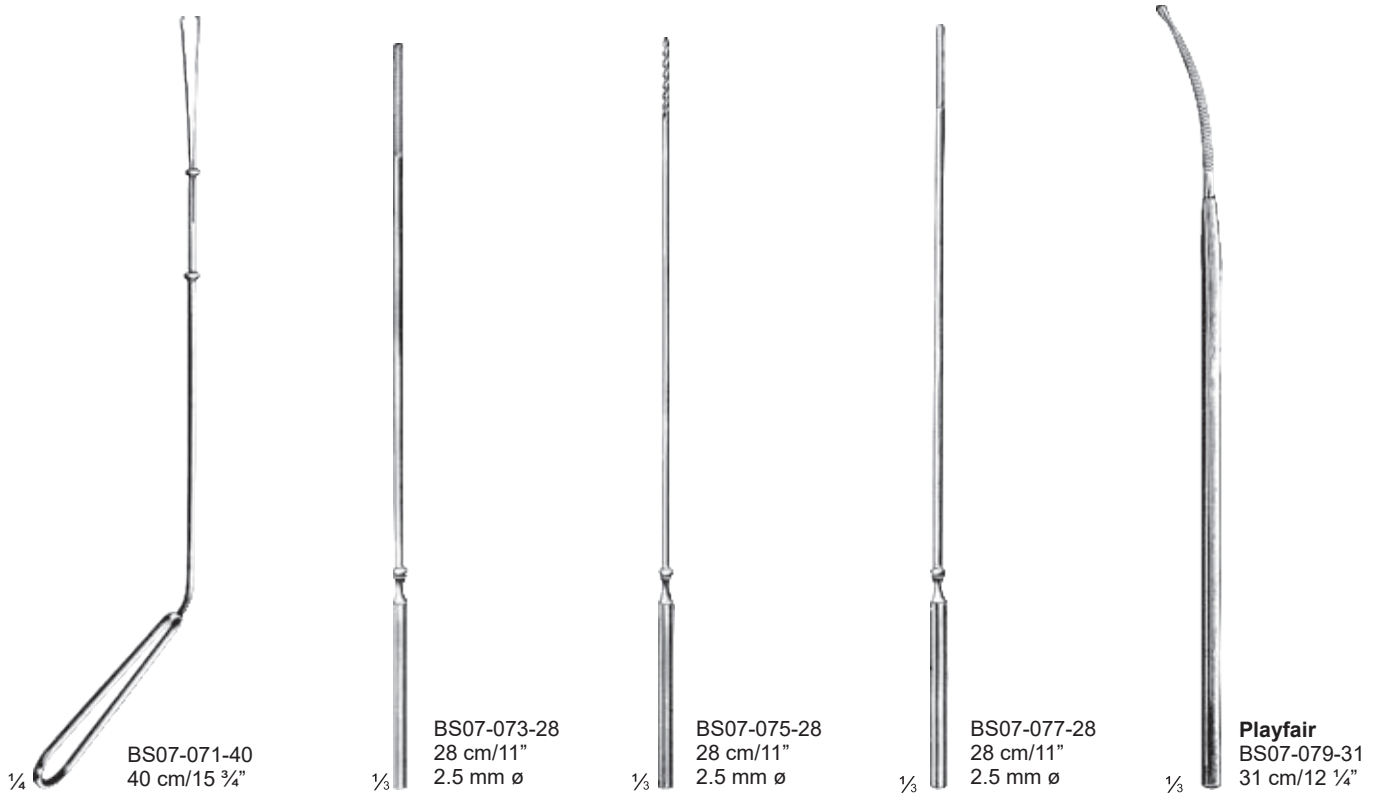
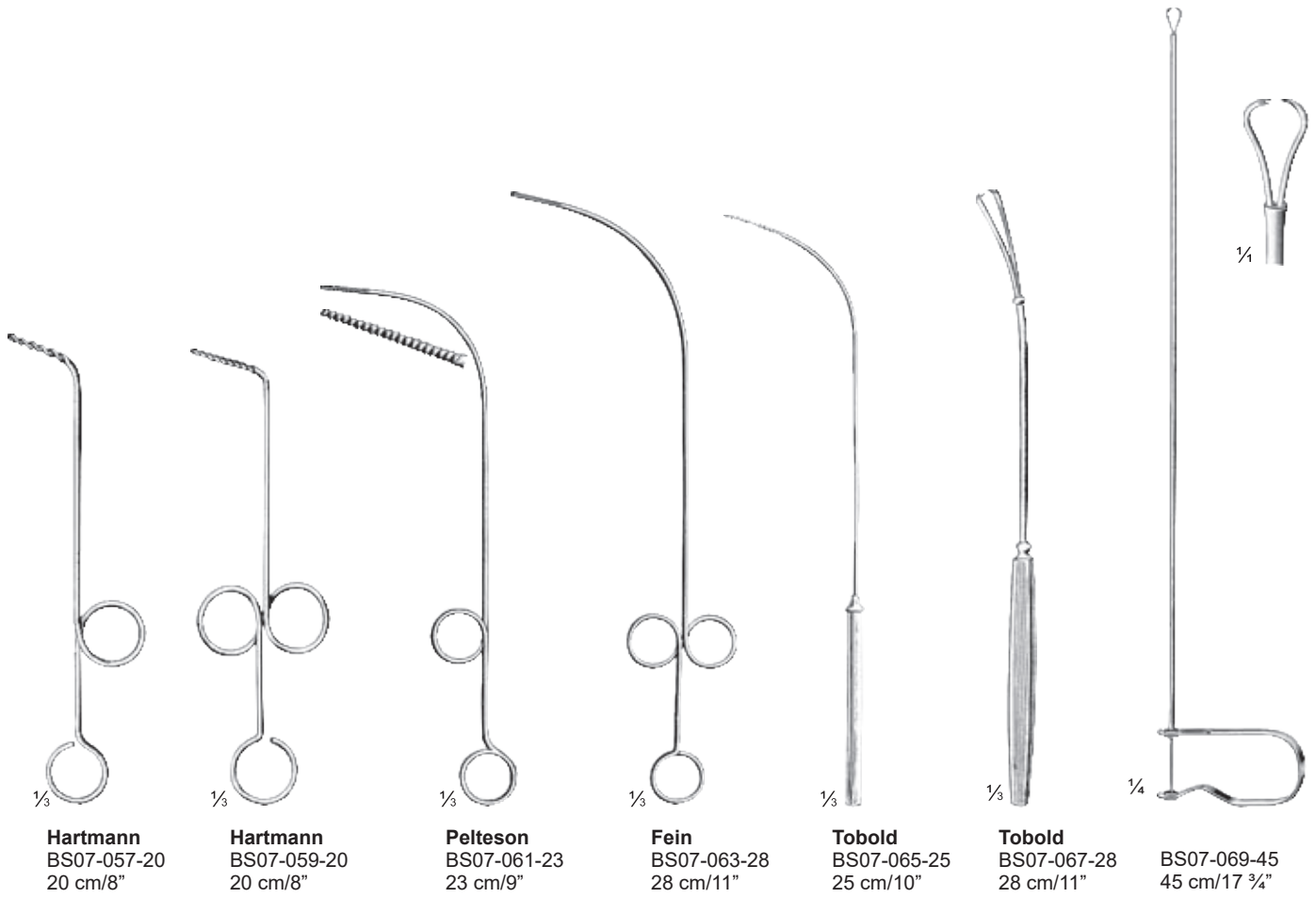



Suction Tubes



**Poole**  
BS07-081-22  
22 cm/8 3/4", 10mm Ø  
(Charr./Fr.30)



**Poole**  
BS07-083-22  
22 cm/8 3/4", 8 mm Ø  
(Charr./Fr.23)

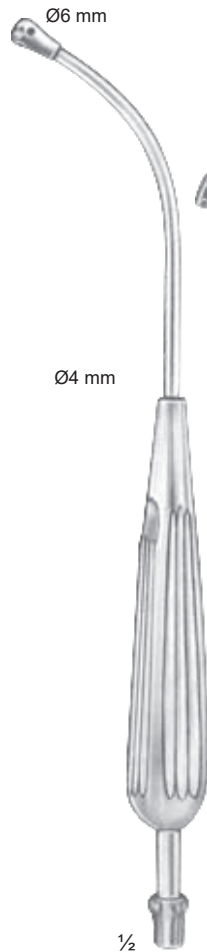

**Andrew-Pynchon**  
24 cm/9 1/2"  
BS07-085-24

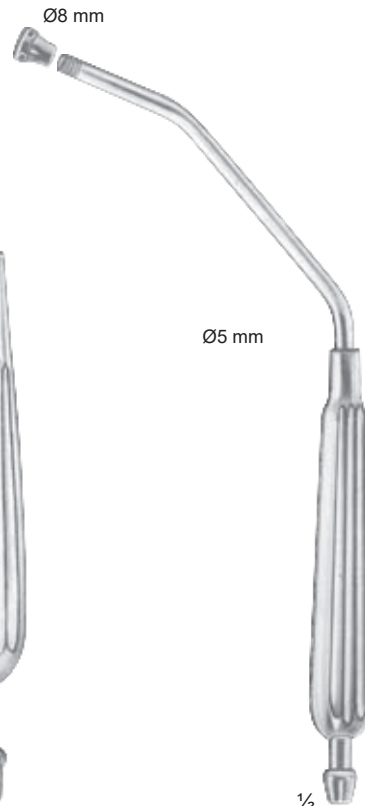

**Baby-Yankauer**  
21 cm/8 1/4"  
BS07-087-21



**Yankauer**  
29.5 cm/11 1/2"  
BS07-087-29



**Frazier**  
13 cm/5"  
BS07-089-20=2.0mm Ø Charr. 6  
BS07-089-27=2.7mm Ø Charr. 8  
BS07-089-33=3.3mm Ø Charr. 10  
BS07-089-40=4.0mm Ø Charr. 12

17 cm/6 3/4"  
BS07-091-20=2.0mm Ø Charr. 6  
BS07-091-27=2.7mm Ø Charr. 8  
BS07-091-33=3.3mm Ø Charr. 10  
BS07-091-40=4.0mm Ø Charr. 12

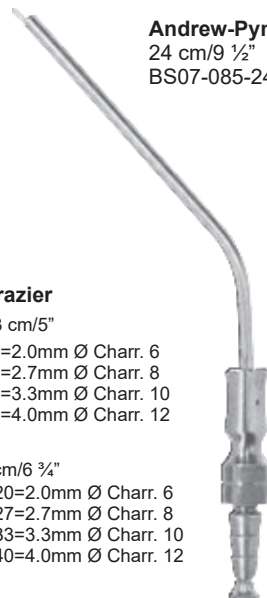

**Frazier**  
13 cm/5"  
BS07-093-20=2.0mm Ø Charr. 6  
BS07-093-27=2.7mm Ø Charr. 8  
BS07-093-33=3.3mm Ø Charr. 10  
BS07-093-40=4.0mm Ø Charr. 12

17 cm/6 3/4"  
BS07-095-20=2.0mm Ø Charr. 6  
BS07-095-27=2.7mm Ø Charr. 8  
BS07-095-33=3.3mm Ø Charr. 10  
BS07-095-40=4.0mm Ø Charr. 12

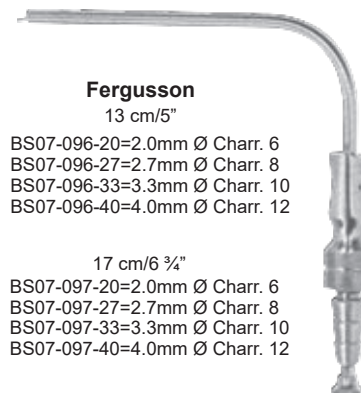

**Fergusson**  
13 cm/5"  
BS07-096-20=2.0mm Ø Charr. 6  
BS07-096-27=2.7mm Ø Charr. 8  
BS07-096-33=3.3mm Ø Charr. 10  
BS07-096-40=4.0mm Ø Charr. 12

17 cm/6 3/4"  
BS07-097-20=2.0mm Ø Charr. 6  
BS07-097-27=2.7mm Ø Charr. 8  
BS07-097-33=3.3mm Ø Charr. 10  
BS07-097-40=4.0mm Ø Charr. 12





**Adson Charr. 12**  
BS07-099-40  
21cm/8 1/4", 4mmØ



**Adson Charr. 12**  
BS07-101-40  
21cm/8 1/4", 4mmØ



Cylindrical, silver

**Wullstein**  
BS07-103-15 Ø 1.5 mm  
BS07-103-20 Ø 2.0 mm  
16 cm/6 1/4"



3.0 x 1.75 mm Ø  
conical, silver

**Wullstein**  
BS07-105-30  
16 cm/6 1/4"



Handle with thumb valve for  
Wullstein suction tubes

**Wullstein**  
BS07-107-50  
10.5 cm/4 1/4"

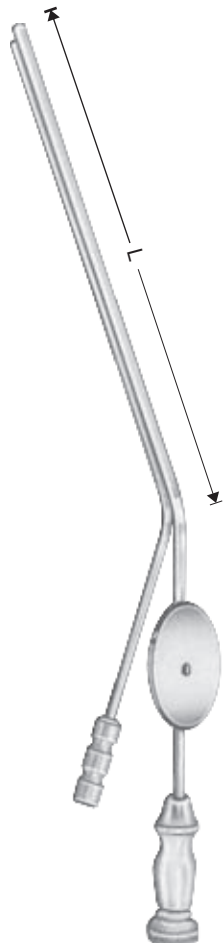

Irrigation and suction Instruments, with thumb valve

L = 9cm/3 1/2"

L = 18cm/7"

Suction tube		Irrigation tube		Suction tube		Irrigation tube	
mmØ		mmØ		mmØ		mmØ	
0.9	X	0.7	BS07-109-09				
1.2	X	0.9	BS07-109-12				
1.5	X	1.2	BS07-109-15				
1.8	X	1.8	BS07-109-18	1.8	X	1.8	BS07-111-18
2.5	X	2.0	BS07-109-25	2.5	X	2.0	BS07-111-25
3.0	X	2.0	BS07-109-30	3.0	X	2.0	BS07-111-30
4.5	X	2.0	BS07-109-45				

House-Luer



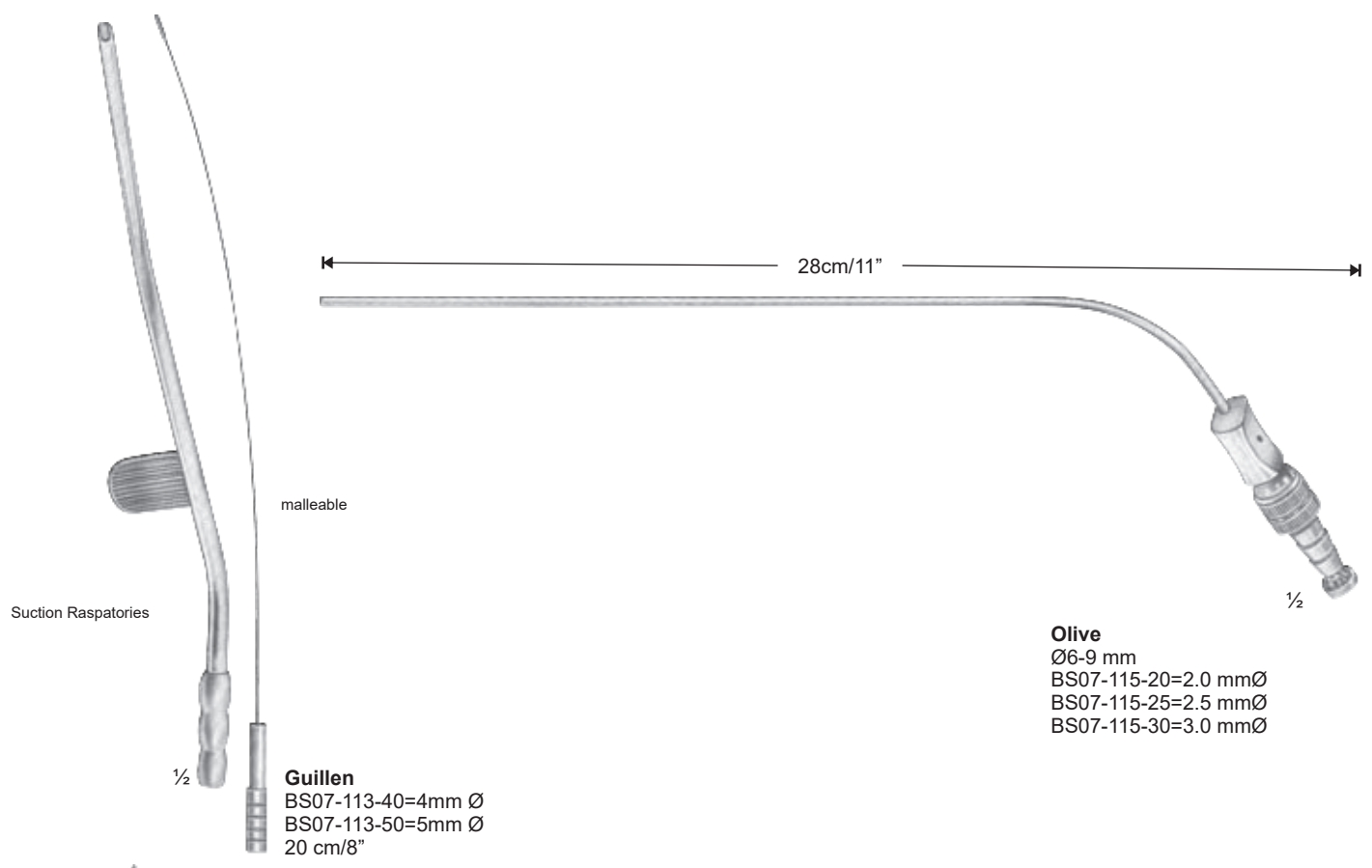

**Olive**  
Ø6-9 mm  
BS07-115-20=2.0 mmØ  
BS07-115-25=2.5 mmØ  
BS07-115-30=3.0 mmØ

Trocars

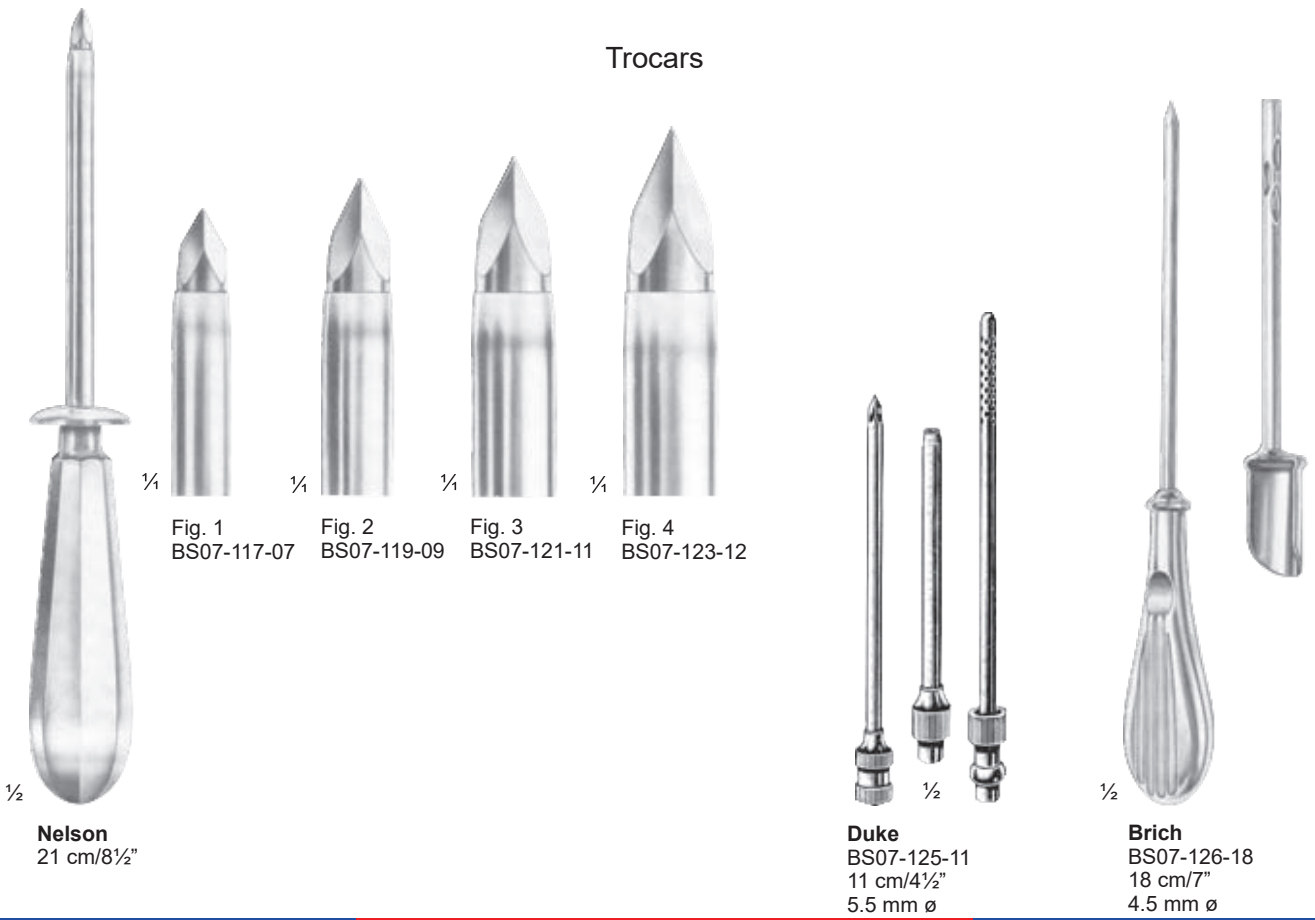



ø mm	11 cm/4½"
3.0	BS07-127-11
3.5	BS07-129-11
4.0	BS07-131-11
4.5	BS07-133-11
5.0	BS07-135-11
5.5	BS07-137-11
6.0	BS07-139-11

Standard



ø mm	12 cm/4¾"
3.0	BS07-141-12
3.5	BS07-143-12
4.0	BS07-145-12
4.5	BS07-147-12
5.0	BS07-149-12
5.5	BS07-151-12
6.0	BS07-153-12

Standard



ø mm	12 cm/4¾"
3.0	BS07-155-12
3.5	BS07-157-12
4.0	BS07-159-12
4.5	BS07-161-12
5.0	BS07-163-12
5.5	BS07-165-12
6.0	BS07-167-12

Standard

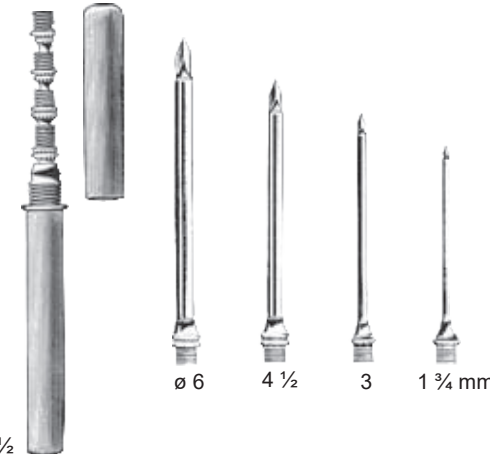

ø 6    4 ½    3    1 ¾ mm

**Universal**  
 BS07-169-03 set of 3 Pieces  
 BS07-171-04 set of 4 pieces



**Universal**  
 BS07-173-03 set of 3 Pieces  
 BS07-175-04 set of 4 pieces



**Ochsner**  
 mm ø

4.0	BS07-177-10
5.5	BS07-179-14
6.5	BS07-181-14



**Billroth**  
 mm ø

5.0	BS07-183-20
6.0	BS07-185-20



**Emmet**  
 mm ø    Charr./Fr.

6.0	18	BS07-187-25
8.7	26	BS07-189-25
10.0	30	BS07-191-25