



# Retractors



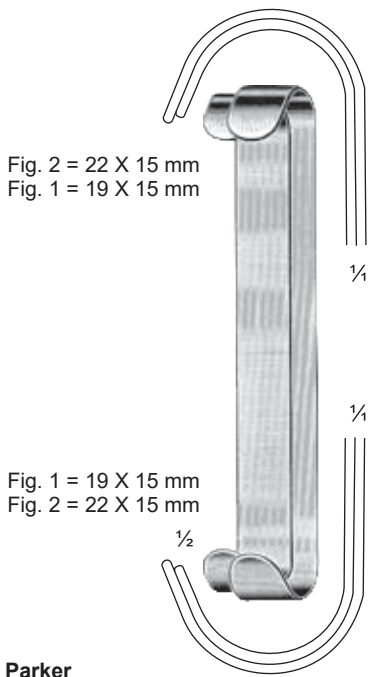

Fig. 2 = 22 X 15 mm  
Fig. 1 = 19 X 15 mm

Fig. 1 = 19 X 15 mm  
Fig. 2 = 22 X 15 mm

**Parker**  
BS08-001-01 = Set  
BS08-001-11 = Fig. 1  
BS08-001-12 = Fig. 2  
13.5 cm/5 1/4"

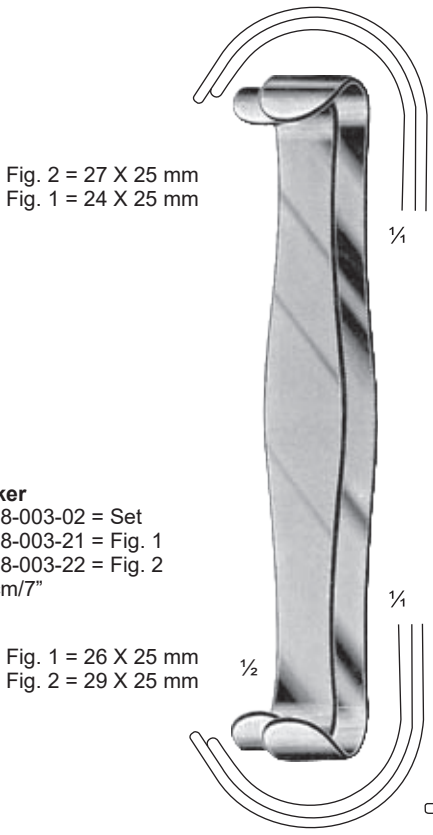

Fig. 2 = 27 X 25 mm  
Fig. 1 = 24 X 25 mm

**Parker**  
BS08-003-02 = Set  
BS08-003-21 = Fig. 1  
BS08-003-22 = Fig. 2  
18 cm/7"

Fig. 1 = 26 X 25 mm  
Fig. 2 = 29 X 25 mm

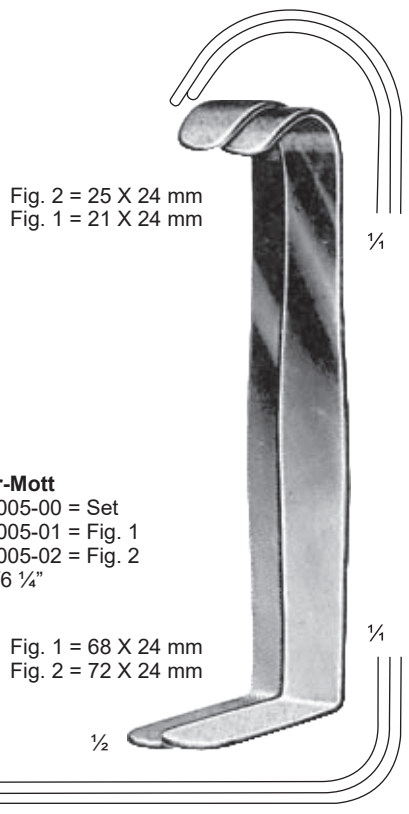
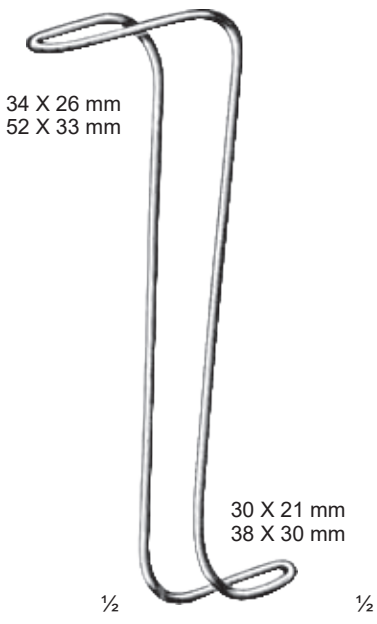

Fig. 2 = 25 X 24 mm  
Fig. 1 = 21 X 24 mm

**Parker-Mott**  
BS08-005-00 = Set  
BS08-005-01 = Fig. 1  
BS08-005-02 = Fig. 2  
16 cm/6 1/4"

Fig. 1 = 68 X 24 mm  
Fig. 2 = 72 X 24 mm



34 X 26 mm  
52 X 33 mm

30 X 21 mm  
38 X 30 mm

**Collin-Hartmann**  
BS08-007-01 = 14 cm/5 1/2"  
BS08-007-02 = 16 cm/6 1/4"

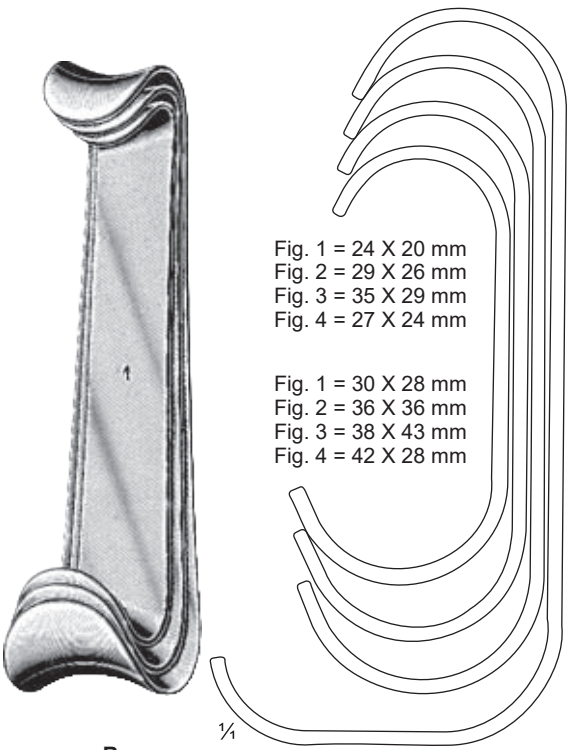

Fig. 1 = 24 X 20 mm  
Fig. 2 = 29 X 26 mm  
Fig. 3 = 35 X 29 mm  
Fig. 4 = 27 X 24 mm

Fig. 1 = 30 X 28 mm  
Fig. 2 = 36 X 36 mm  
Fig. 3 = 38 X 43 mm  
Fig. 4 = 42 X 28 mm

**Roux**  
BS08-009-00 = Set Fig. 1-3  
BS08-009-01 = Fig. 1 = 14 cm/5 1/2"  
BS08-009-02 = Fig. 2 = 15 cm/6"  
BS08-009-03 = Fig. 3 = 17 cm/6 3/4"  
BS08-009-04 = Fig. 4 = 18 cm/7"

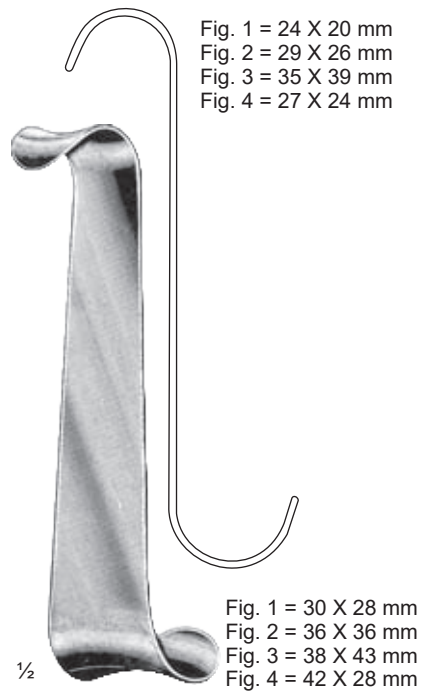

Fig. 1 = 24 X 20 mm  
Fig. 2 = 29 X 26 mm  
Fig. 3 = 35 X 39 mm  
Fig. 4 = 27 X 24 mm

Fig. 1 = 30 X 28 mm  
Fig. 2 = 36 X 36 mm  
Fig. 3 = 38 X 43 mm  
Fig. 4 = 42 X 28 mm

**Roux-Magnus**  
BS08-011-00 = Set Fig. 1-3  
BS08-011-01 = Fig. 1 = 14 cm/5 1/2"  
BS08-011-02 = Fig. 2 = 15 cm/6"  
BS08-011-03 = Fig. 3 = 17 cm/6 3/4"  
BS08-011-04 = Fig. 4 = 18 cm/7"



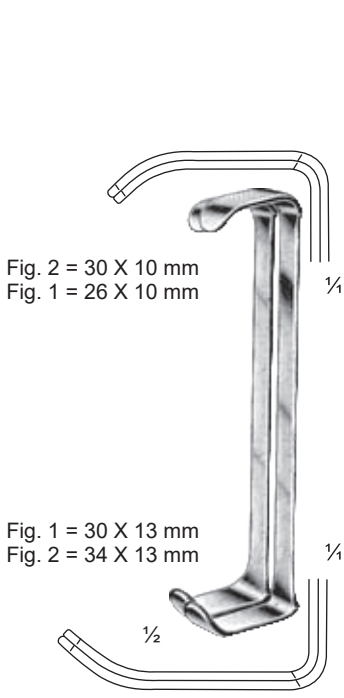

Fig. 2 = 30 X 10 mm  
Fig. 1 = 26 X 10 mm

Fig. 1 = 30 X 13 mm  
Fig. 2 = 34 X 13 mm

**Farabeuf**  
BS08-013-00 = Set  
BS08-013-01 = Fig. 1  
BS08-013-02 = Fig. 2  
12 cm/4 3/4"

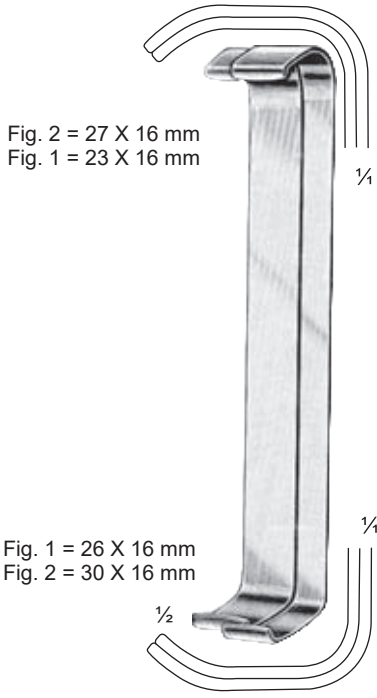
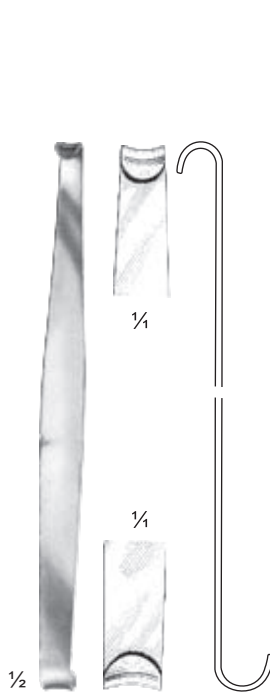

Fig. 2 = 27 X 16 mm  
Fig. 1 = 23 X 16 mm

Fig. 1 = 26 X 16 mm  
Fig. 2 = 30 X 16 mm

**Farabeuf**  
BS08-015-00 = Set  
BS08-015-01 = Fig. 1  
BS08-015-02 = Fig. 2  
12 cm/4 3/4"



**Mini-Roux**  
BS08-017-06

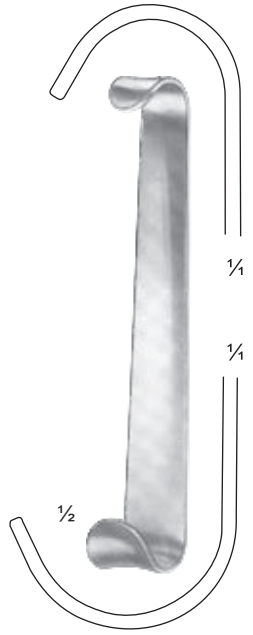

**Baby-Roux**  
BS08-019-13  
13 cm/5 1/4"

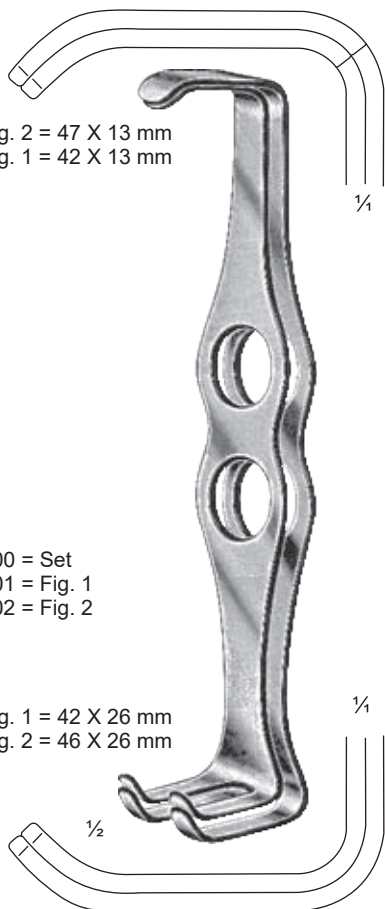

Fig. 2 = 47 X 13 mm  
Fig. 1 = 42 X 13 mm

Fig. 1 = 42 X 26 mm  
Fig. 2 = 46 X 26 mm

**Mathieu**  
BS08-021-00 = Set  
BS08-021-01 = Fig. 1  
BS08-021-02 = Fig. 2  
20 cm/8"

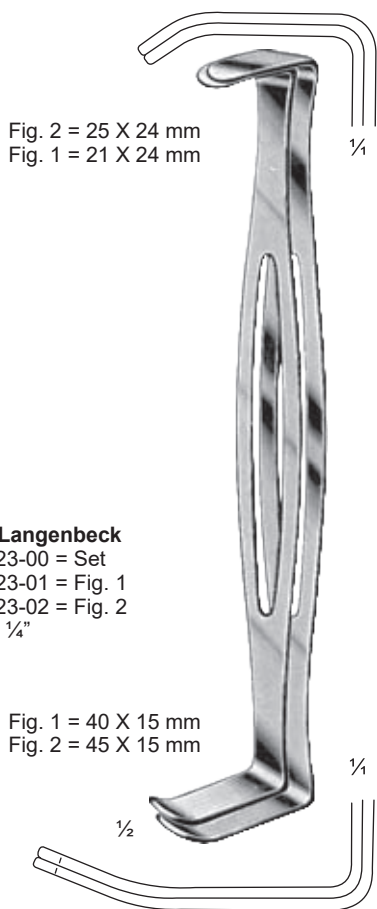

Fig. 2 = 25 X 24 mm  
Fig. 1 = 21 X 24 mm

Fig. 1 = 40 X 15 mm  
Fig. 2 = 45 X 15 mm

**Parker-Langenbeck**  
BS08-023-00 = Set  
BS08-023-01 = Fig. 1  
BS08-023-02 = Fig. 2  
21 cm/8 1/4"



37 X 40 mm

30 X 31 mm

**Goelet**  
BS08-025-00  
19 cm/7 1/2"

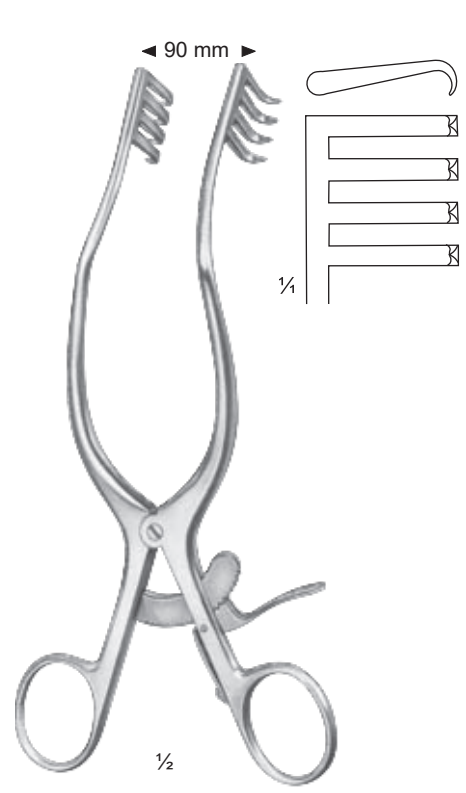

**Anderson-Adson**  
BS08-027-20  
19.5 cm/8"

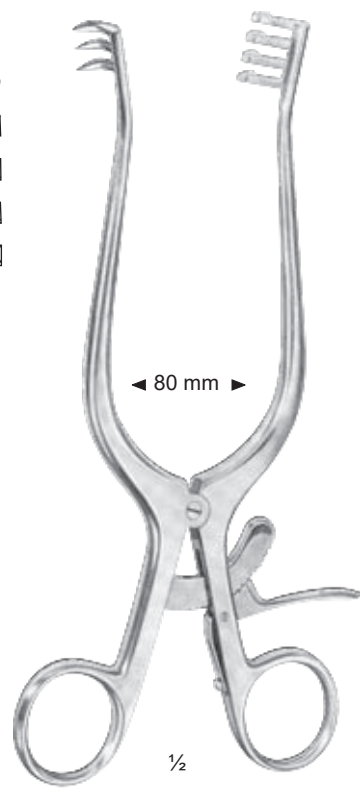

**Weitlaner**  
BS08-029-20  
20 cm/8"

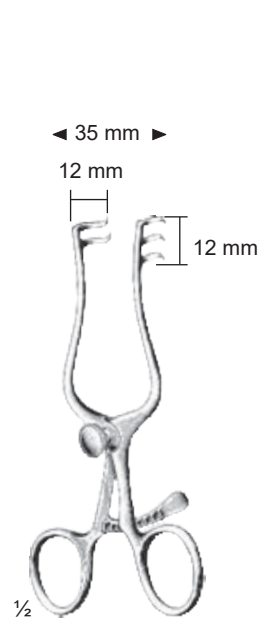
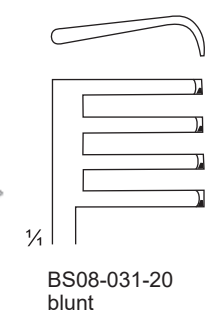
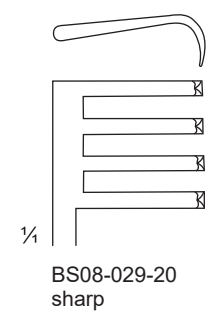

**Weitlaner**  
BS08-033-10 sharp  
BS08-035-10 blunt  
10.5cm/4 1/4"

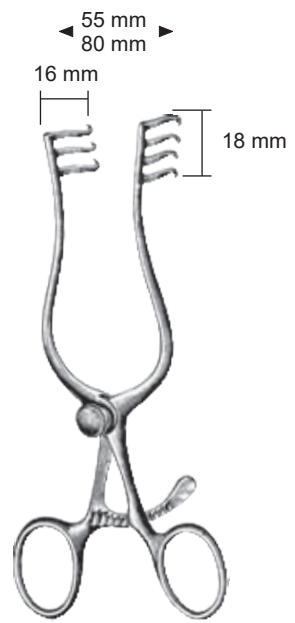

**Weitlaner**

	sharp	cm	in.	blunt
BS08-037-13		13.0	5	BS08-039-13
BS08-037-16		16.5	6 1/2	BS08-039-16

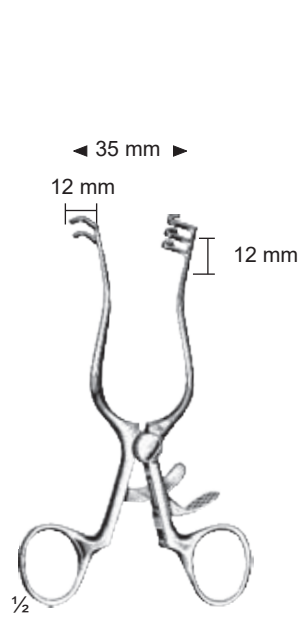

**Weitlaner-Loktite**  
BS08-041-10 sharp  
BS08-043-10 blunt  
10.5cm/4 1/4"

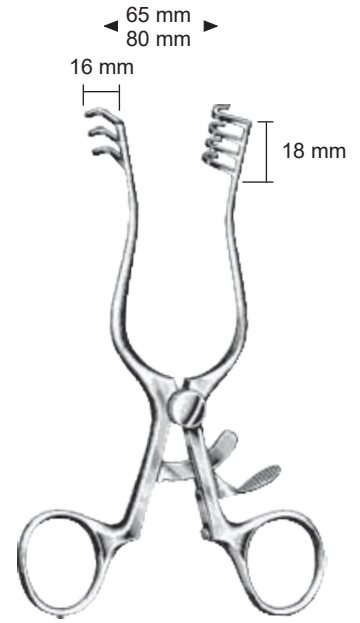

**Weitlaner-Loktite**

	sharp	cm	in.	blunt
BS08-045-13		13.0	5	BS08-047-13
BS08-045-16		16.5	6 1/2	BS08-047-16

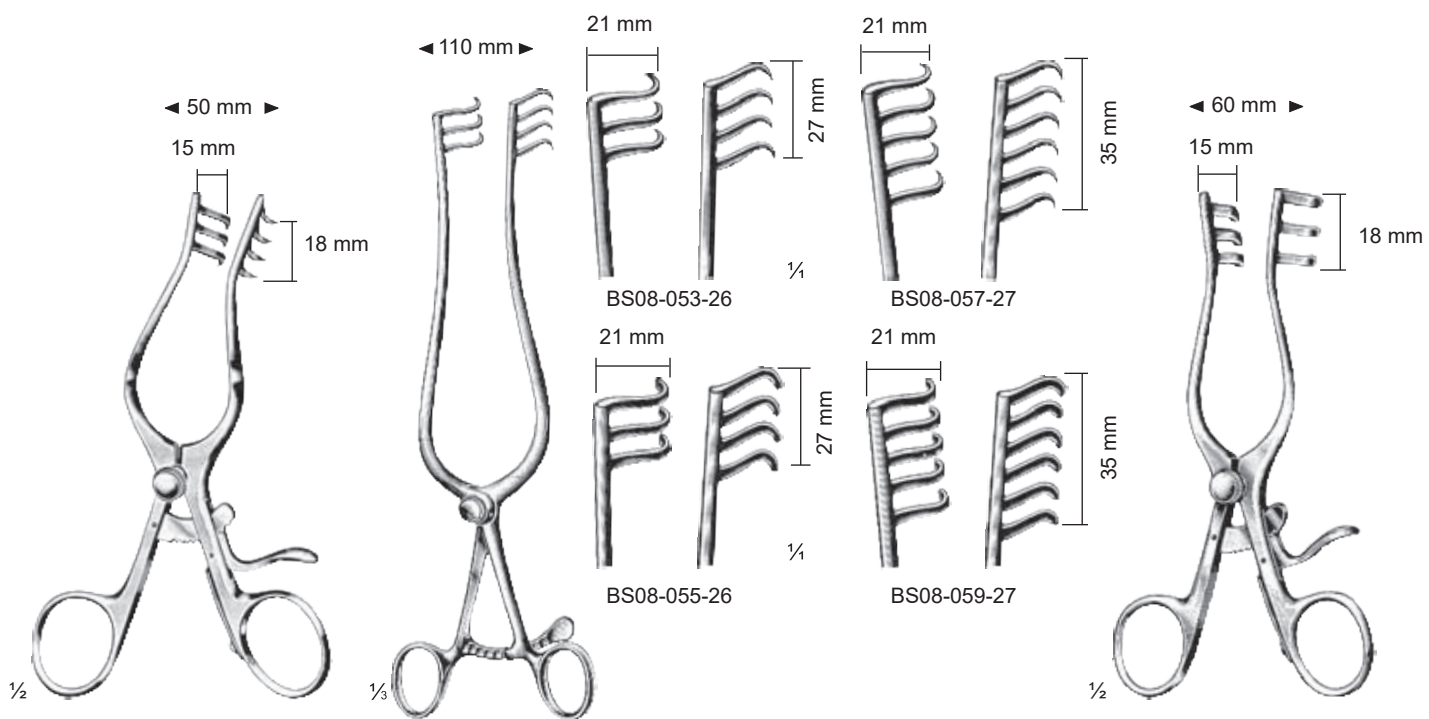

**Weitlaner-Wullstein**  
BS08-049-13 sharp  
BS08-051-13 blunt  
13 cm/5"

**Weitlaner**  
BS08-053-26 sharp  
BS08-055-26 blunt  
26 cm/10 1/4"

**Weitlaner**  
BS08-057-27 sharp  
BS08-059-27 blunt  
27 cm/10 1/2"

**Milligan**  
13 cm/5"  
BS08-061-13 blunt

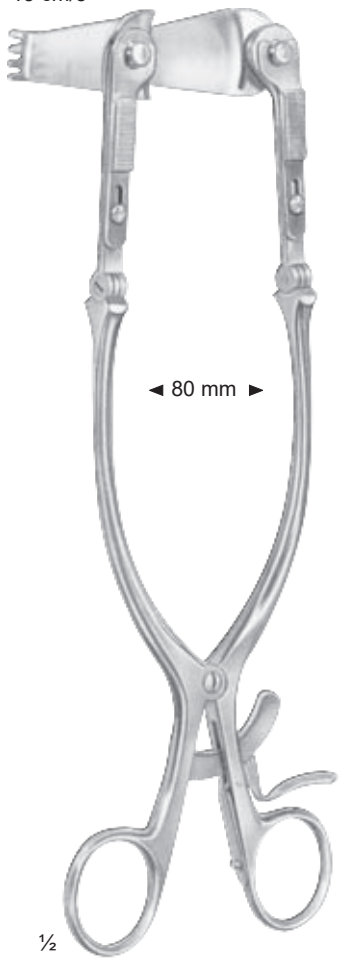

80 mm

**Cloward**

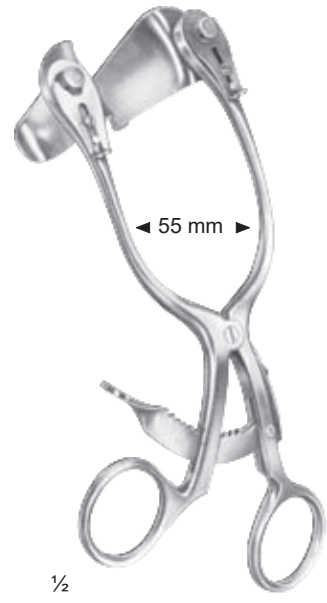
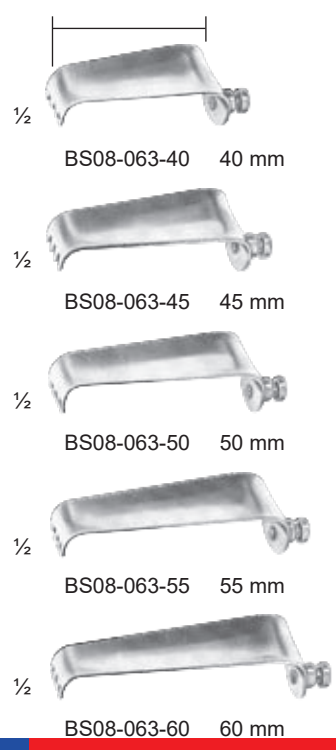

55 mm

**Cloward**

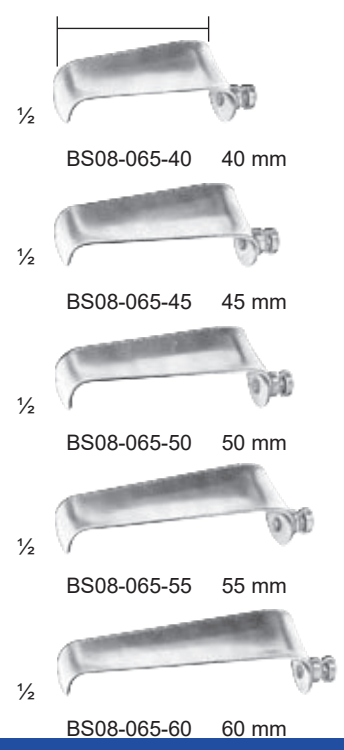

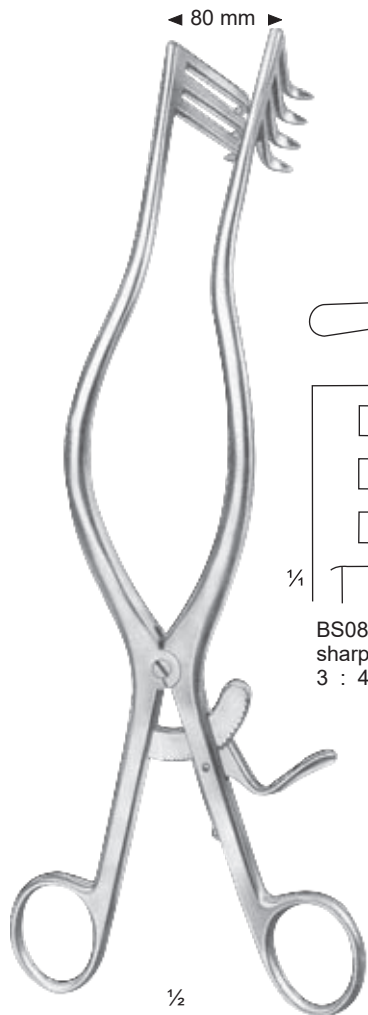

**Adson**  
26.5 cm/10 1/2"

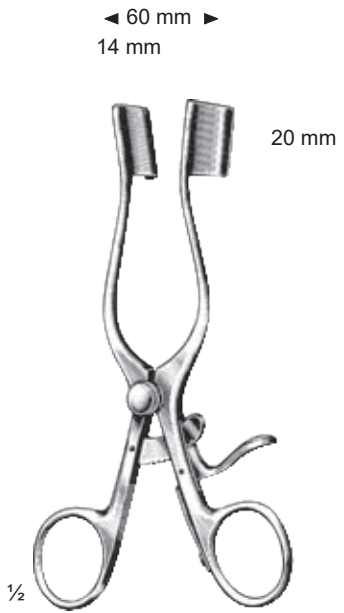
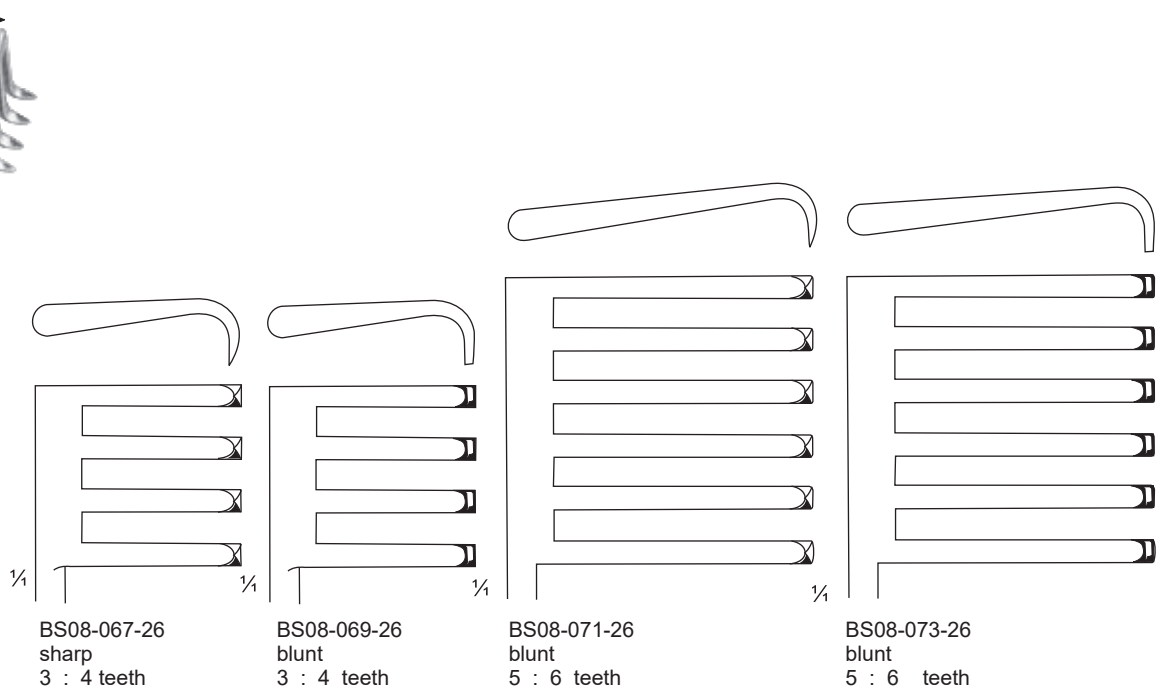

**Weitlaner-Baby**  
BS08-075-13  
13 cm/5"

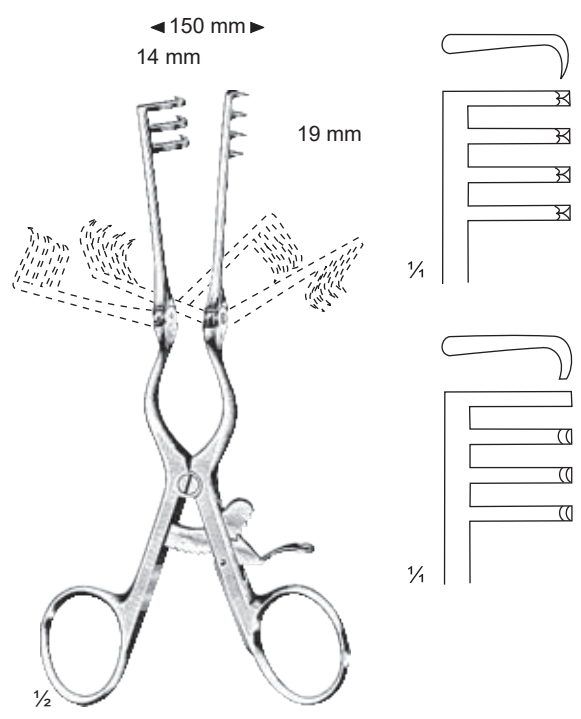

**Adson-Baby**  
BS08-077-16 sharp  
BS08-079-16 blunt  
16 cm/6 1/2"

Retractors

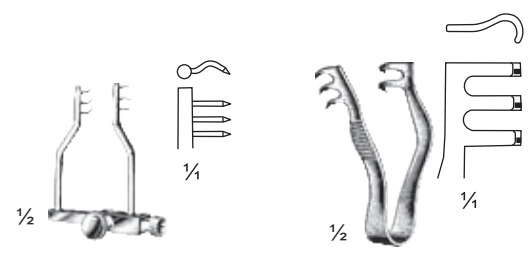

**Logan**  
BS08-081-04  
4 cm/1 1/2"

**Finsen**  
BS08-082-05 sharp  
BS08-083-05 blunt  
5 cm/2"



**Adson**  
BS08-084-32  
32 cm/12 1/2"



**Beckmann-Eaton**  
BS08-085-32  
32 cm/12 1/2"

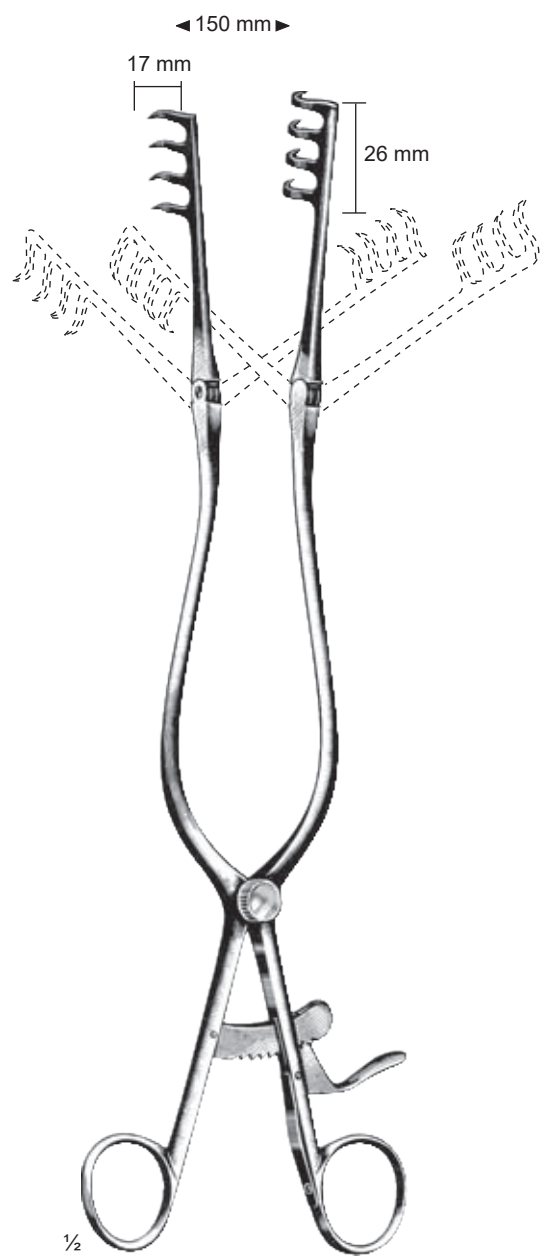

**Beckmann**  
BS08-086-31  
31 cm/12 1/4"

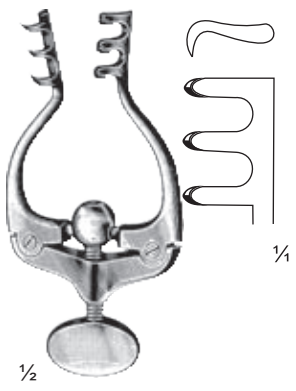

**Jansen**  
BS08-087-10  
10 cm/4"  
sharp

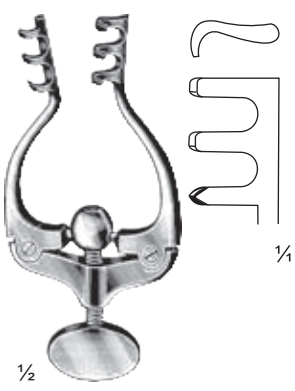

**Jansen**  
BS08-088-10  
10 cm/4"  
with 1 sharp and  
2 blunt prongs each

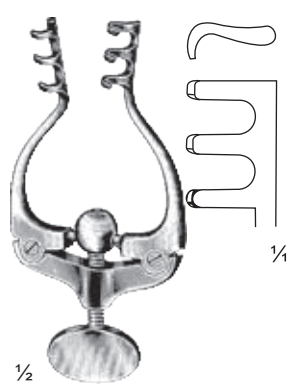

**Jansen**  
BS08-089-10  
10 cm/4"  
blunt

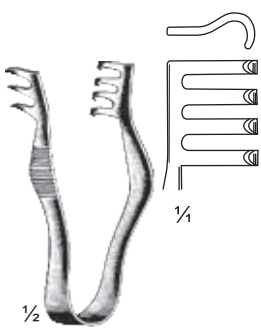

**Finsen**  
BS08-090-07 sharp  
BS08-091-07 blunt  
7 cm/2 3/4"

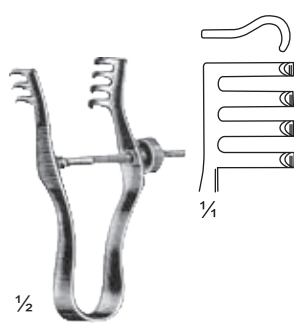

**Finsen-Mod. Martin**  
BS08-093-07 sharp  
BS08-095-07 blunt  
7 cm/2 3/4"

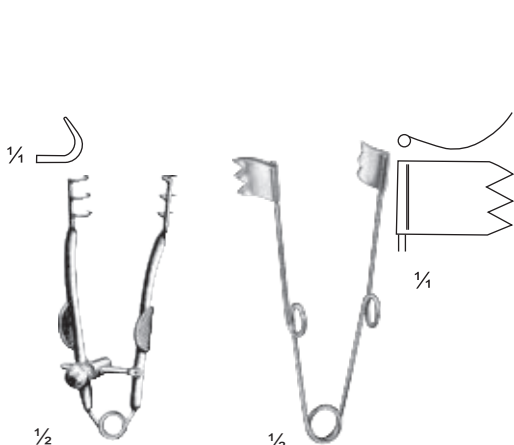

**Buckley**

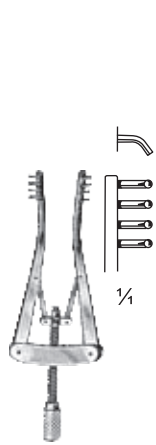

**Alm**

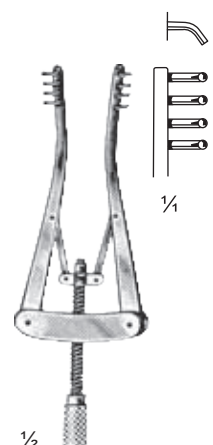

Semi-sharp



Blunt

cm	in.	Sharp	Sharp	Blunt	Semi-sharp	Blunt
6	2 1/4	BS08-097-06				
7	2 3/4		BS08-101-07	BS08-103-07		
8	3 1/4		BS08-099-08			
10	4		BS08-101-10	BS08-103-10	BS08-105-10	BS08-107-10



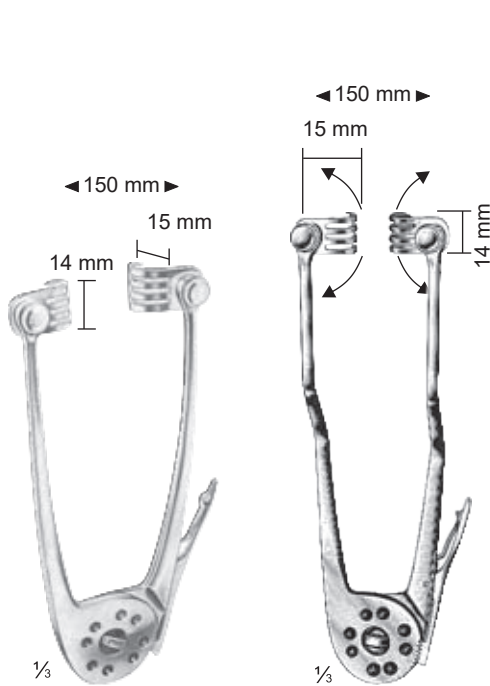

**Kocher**  
BS08-109-16  
16 cm/6 1/4"

**Crotti**  
BS08-111-18  
18.5 cm/7 1/4"

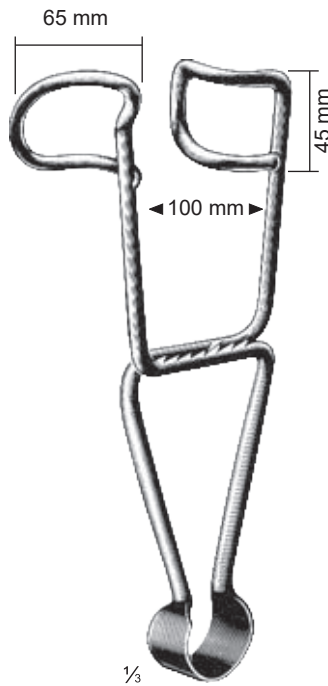

**Dartigues**  
BS08-113-26

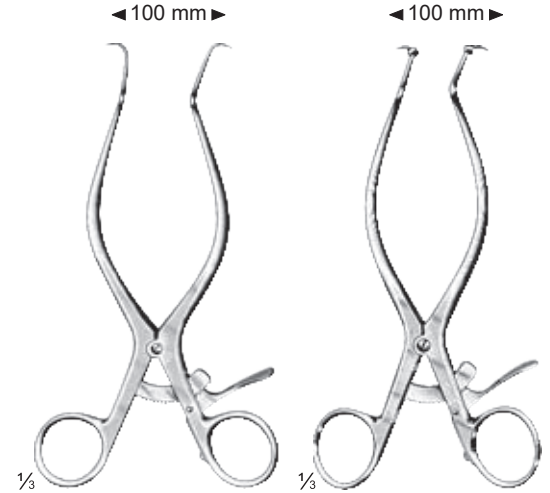

**Gelpi-Loktite**  
BS08-115-18  
(Perineum)

**Gelpi-Loktite**  
BS08-117-18  
(Perineum)



BS08-119-17  
17 cm/6 3/4"

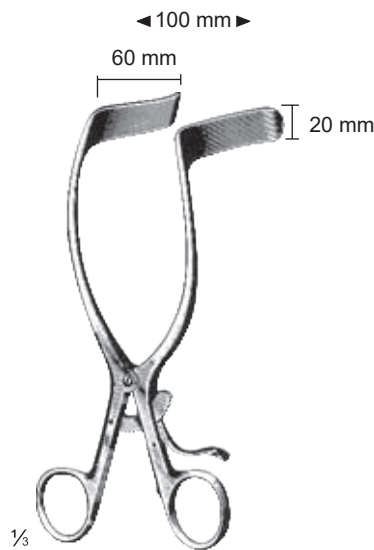

**Rigby**  
BS08-121-18  
(Rektum, Vagina)

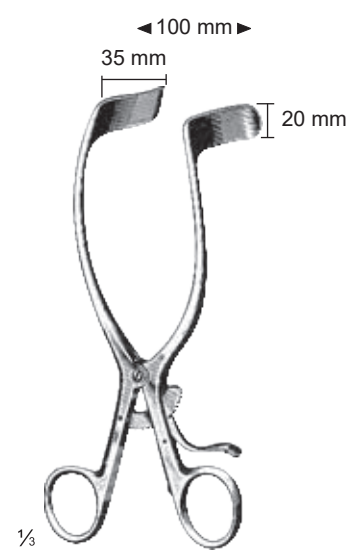

BS08-123-18  
18 cm/7"

Abdominal Retractors

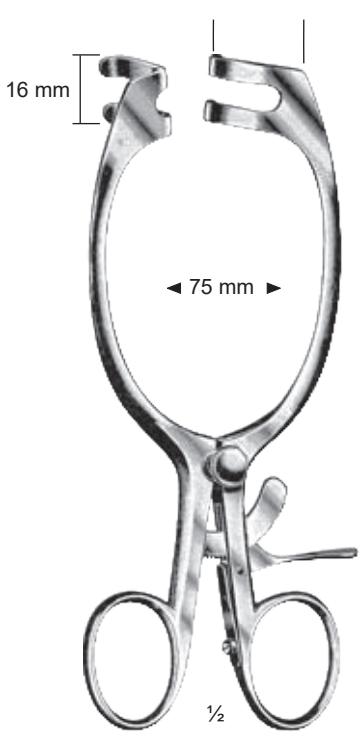

**Mayo-Adams**  
BS08-125-17

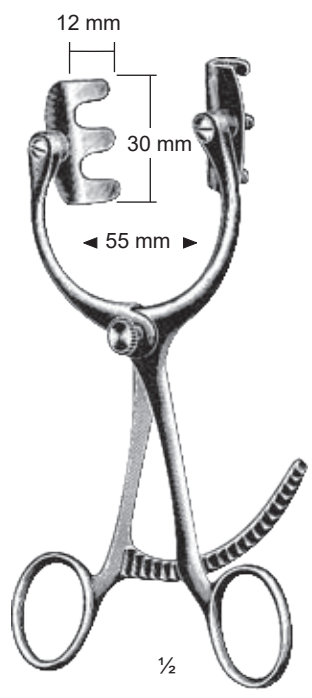

**Houzel**  
BS08-127-16

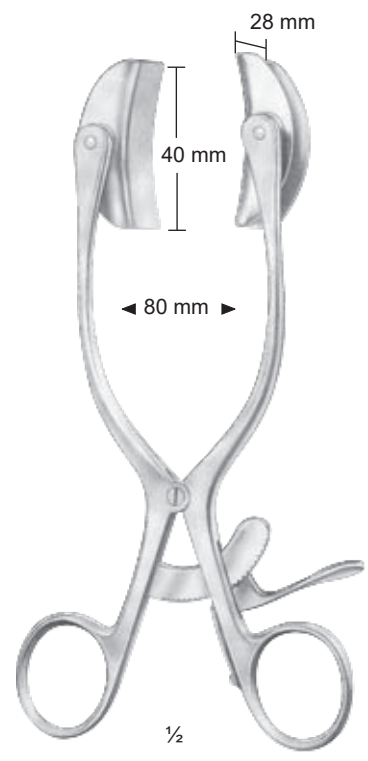

**Baby-Collin**  
BS08-129-00  
complete, with 2 pairs of blades

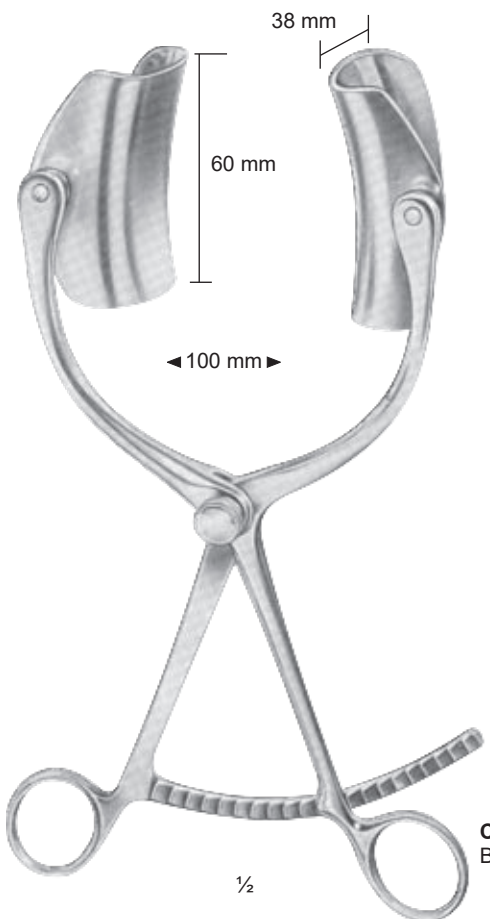
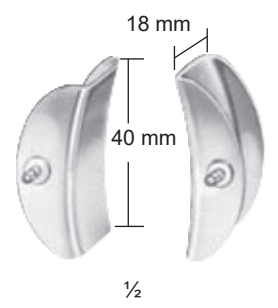
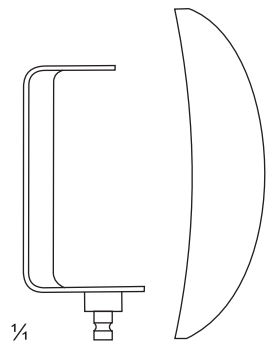

**Collin**  
BS08-131-22

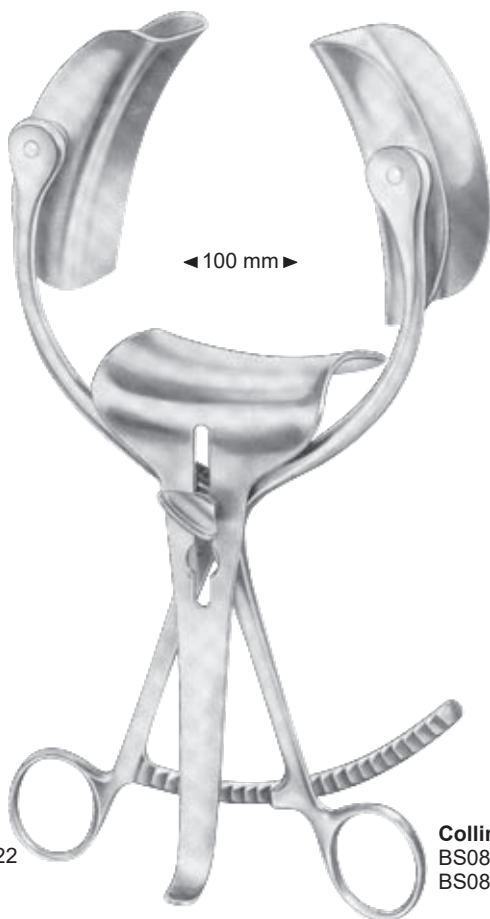

**Collin**  
BS08-133-00 = 38 X 60 mm/38 X 55 mm  
BS08-135-00 = 38 X 80 mm/50 X 75 mm

Measurements see below



Exchangeable Blades

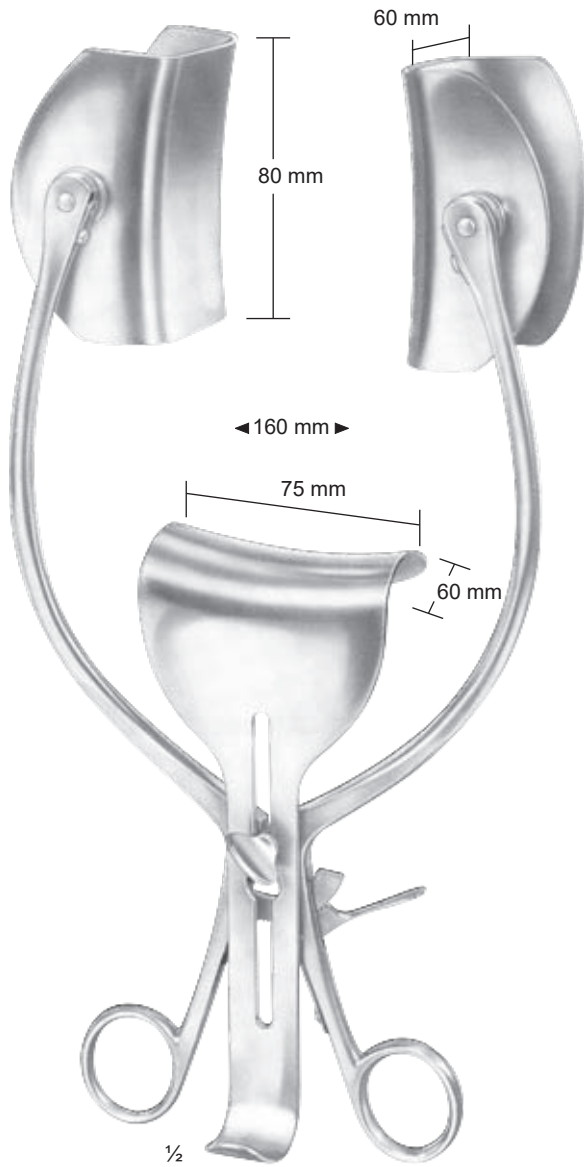

**Collin-Loktite**  
BS08-137-00



**Robin-Masse**  
BS08-139-00 = 40 X 80 mm/40 X 55 mm 160 mm

**Ricard**  
BS08-141-00 = 80 X 90 mm/80 X 90 mm 300 mm

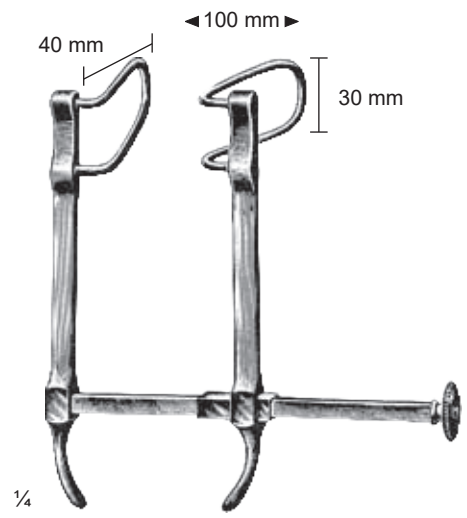

**Gosset**  
BS08-143-00

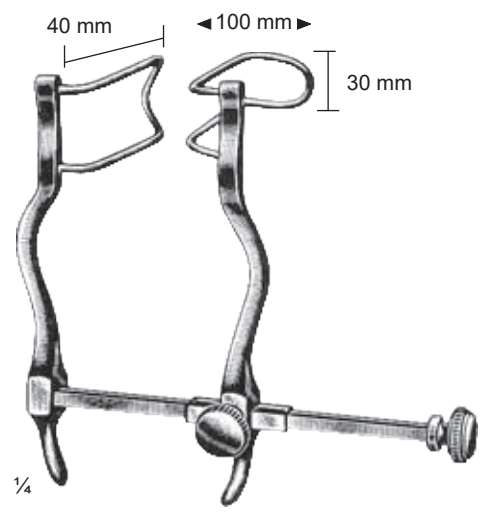

**Gosset**  
BS08-145-00

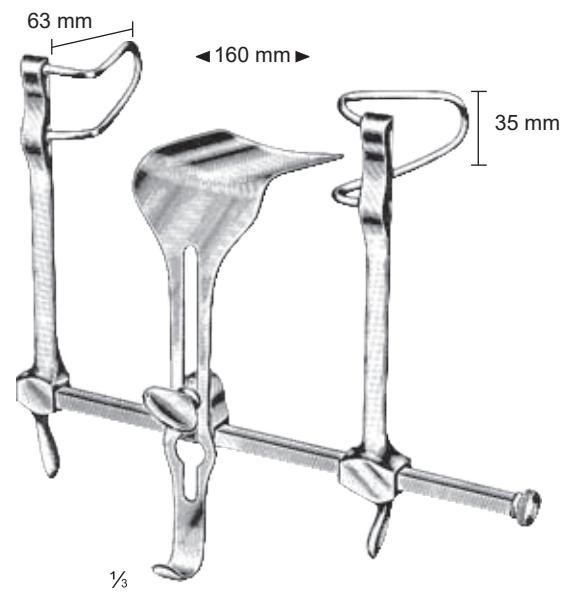

**Gosset**  
BS08-147-00

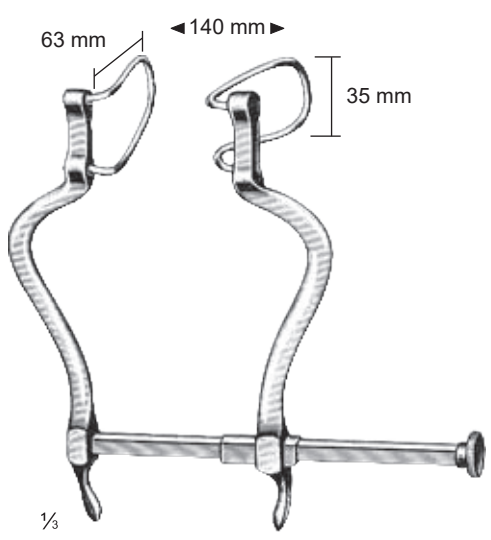

**Gosset**  
BS08-149-00

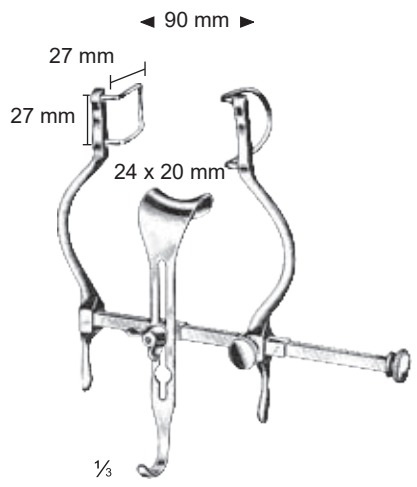

**Balfour-Baby**  
BS08-151-00

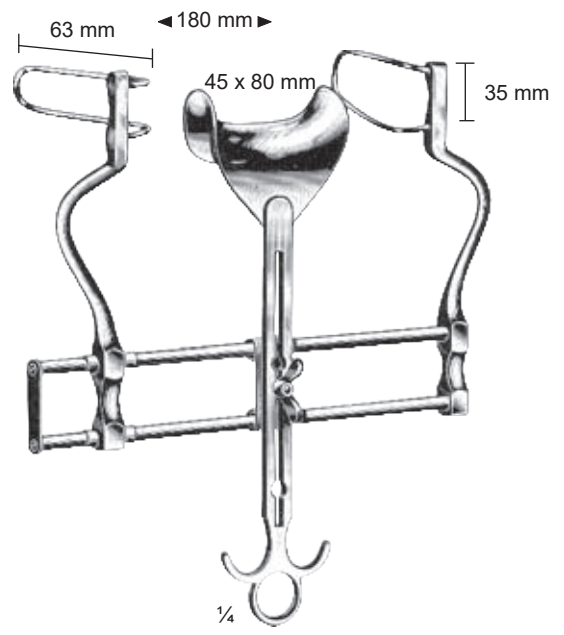

**Balfour**  
BS08-153-00

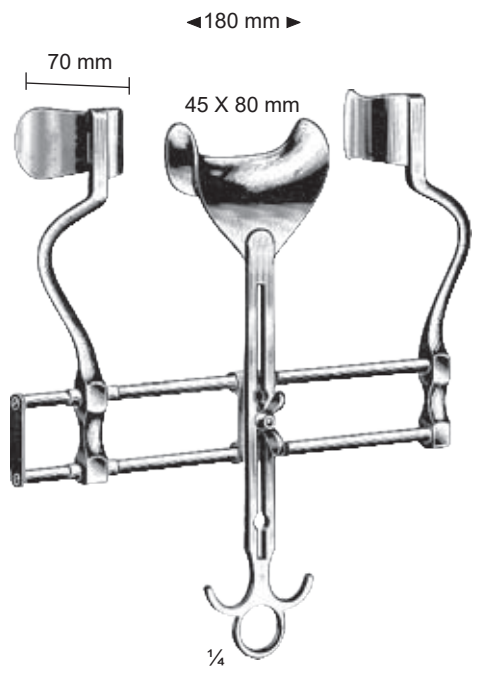

**Balfour**  
BS08-155-00

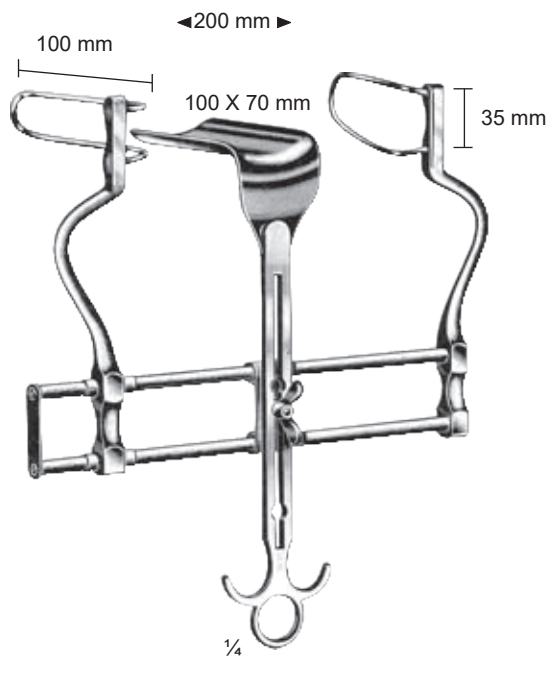

**Balfour**  
BS08-157-00

Abdominal Retractors

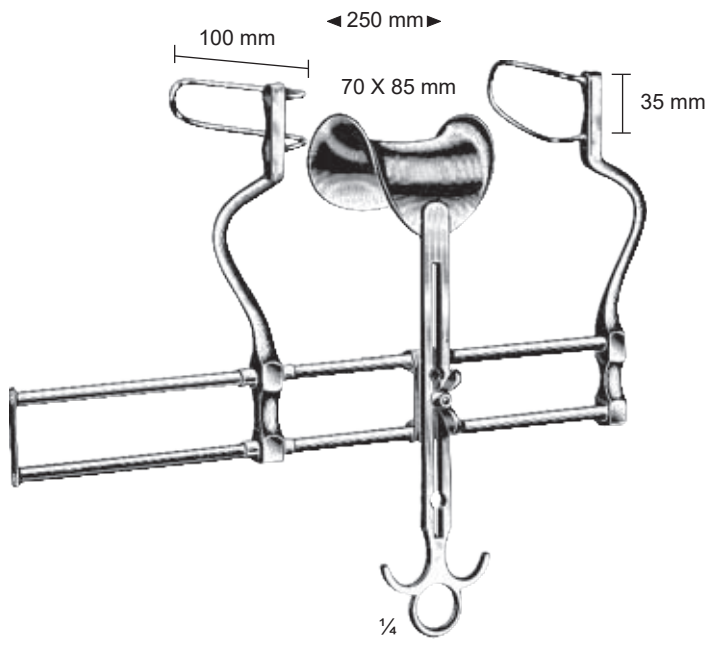

**Balfour**  
BS08-159-00



**Balfour**  
BS08-161-01 = 45 X 80 mm  
BS08-161-02 = 70 X 85 mm  
BS08-161-03 = 80 X 90 mm



**Doyen**  
BS08-163-02 = 55 X 095 mm  
BS08-163-02 = 55 X 105 mm  
BS08-163-03 = 55 X 115 mm  
BS08-163-04 = 55 X 125 mm



**Qyervain**  
BS08-165-00



**O'Sullivan-O'Connor**  
BS08-167-00

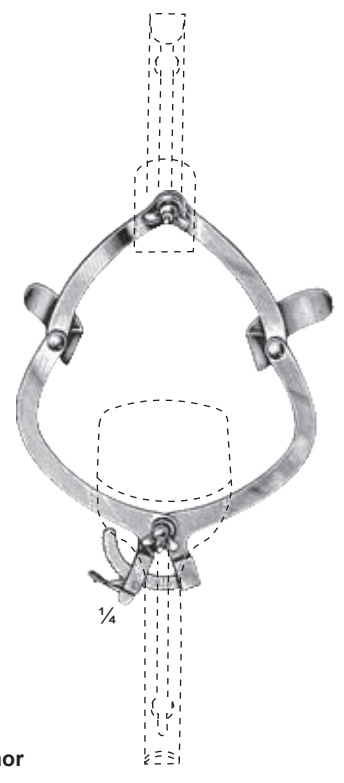

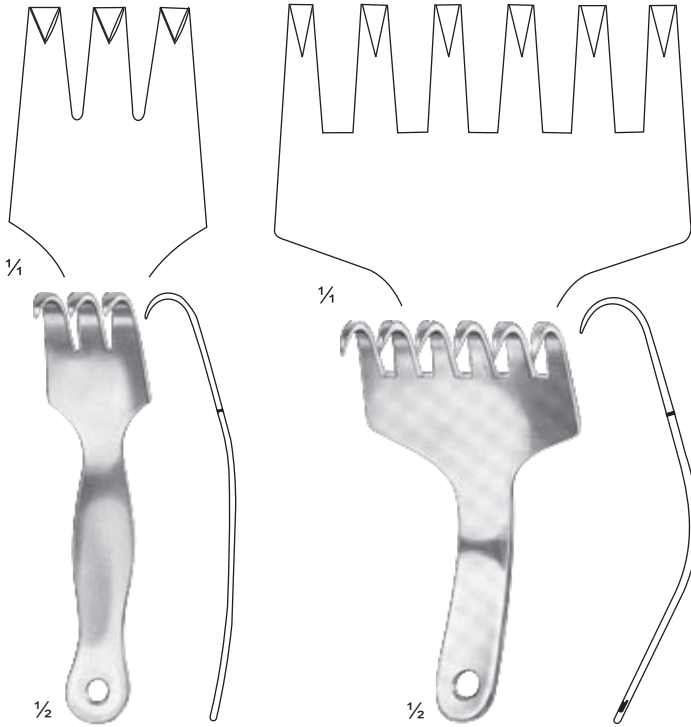

BS08-169-03  
10.5 cm/4 1/4"  
10 X 22 mm

BS08-169-06  
10.5 cm/4 1/4"  
15 X 55 mm

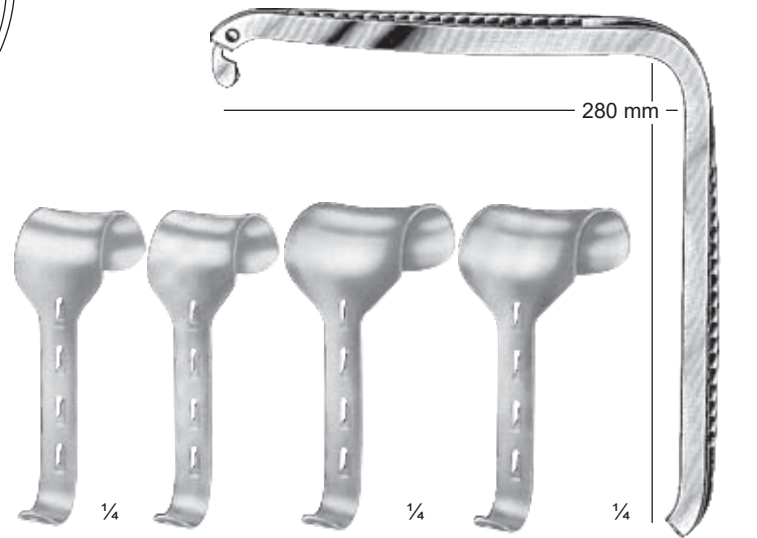

BS08-175-40  
40 x 55 mm

BS08-175-50  
50 x 65 mm

BS08-173-28

**Kirschner**  
BS08-173-00

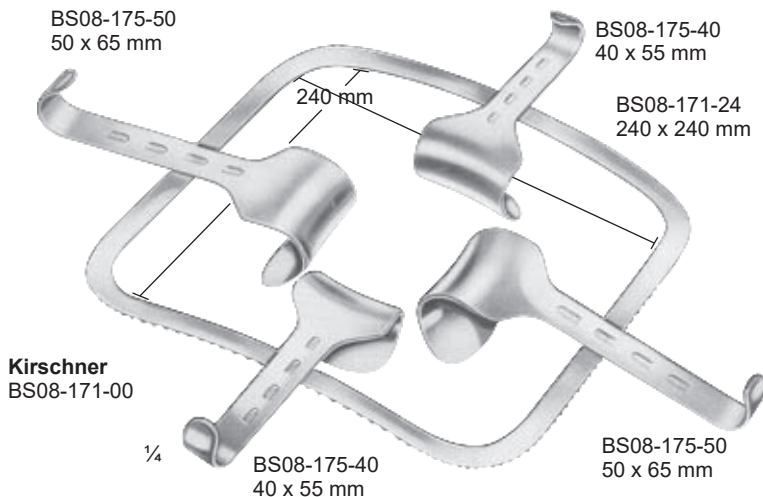

**Kirschner**  
BS08-171-00

BS08-175-50  
50 x 65 mm

BS08-175-40  
40 x 55 mm

BS08-171-24  
240 x 240 mm

BS08-175-40  
40 x 55 mm

BS08-175-50  
50 x 65 mm

**BS08-171-00 - Kirschner Abdominal Retractor, complete, consisting of:**

- BS08-171-24 - Frame, rigid, 240 x 240 mm
- BS08-175-40 - 2 Hook-on Retractors, 40 x 55 mm
- BS08-175-50 - 2 ditto, 50 x 65 mm
- BS08-171-24 - Frame only, rigid, 240 x 240 mm

**BS08-173-00 - Kirschner Abdominal Retractor, folding, large size, complete, consisting of:**

- BS08-173-28 - 1 Frame, folding type, large size, 280 x 280 mm
- BS08-175-40 - 2 Hook-on Retractors, 40 x 55 mm
- BS08-175-50 - 2 ditto, 50 x 65 mm
- BS08-173-28 - Frame only, folding type, 280 x 280 mm

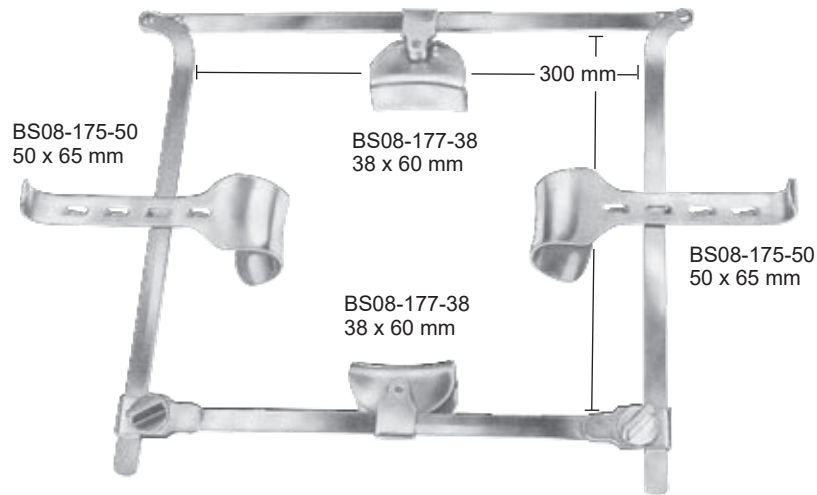

**Franz (complete)**  
BS08-179-00      BS08-181-00  
with 4 blades      with 8 blades

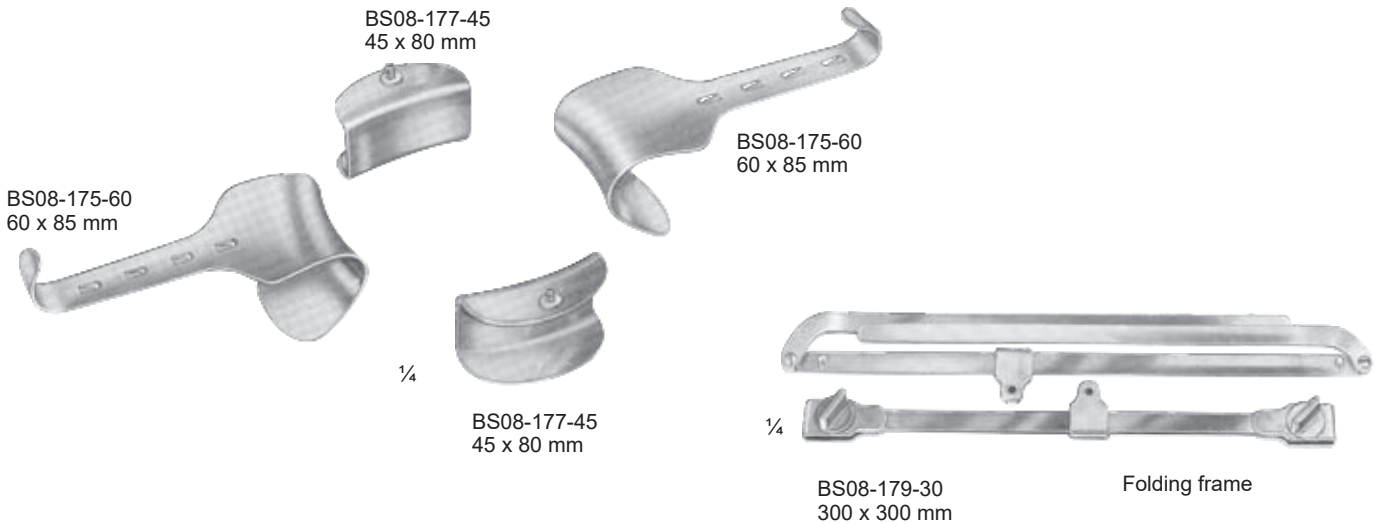

- BS08-179-00** - Franz Abdominal Retractor, folding, complete, consisting of:
- BS08-179-30 - 1 frame, folding, 300 x 300 mm
- BS08-175-50 - 2 hook-on retractors, 50 x 65 mm
- BS08-177-38 - 2 exchangeable blades 38 x 6 mm
- BS08-179-30 - Frame, folding, only, 300 x 300 mm
  
- BS08-181-00** - Franz Abdominal Retractor, folding, complete, consisting of:
- BS08-179-30 - 1 frame, folding, 300 x 300 mm
- BS08-175-50 - 2 hook-on retractors, 50 x 65 mm
- BS08-175-60 - 2 ditto, 60 x 85 mm
- BS08-177-38 - 2 exchangeable blades, 38 x 60 mm
- BS08-177-45 - 2 ditto, 45 x 80 mm



Abdominal Retractors, Retractors

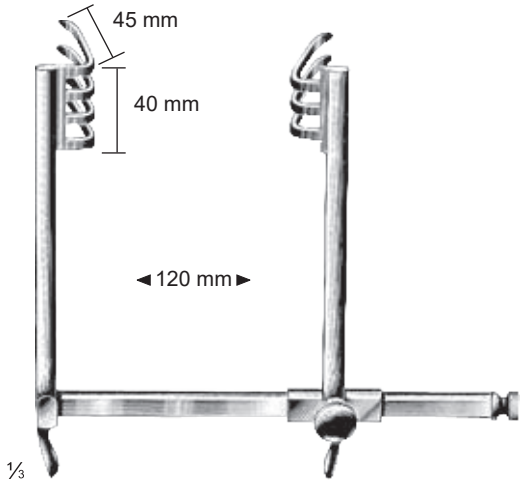

**Temple-Fay**  
BS08-183-00

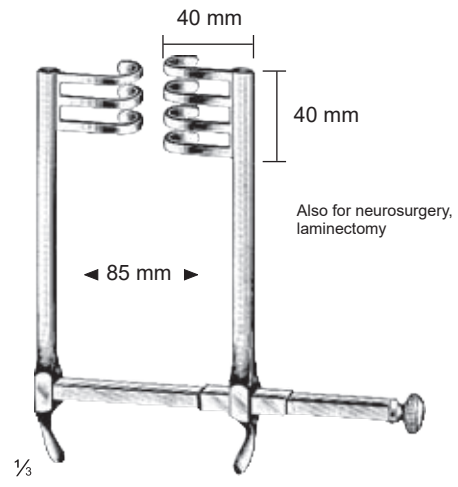

**Frazier**  
BS08-185-00



**Doyen**  
BS08-187-25  
25 cm/10"



**Kocher**  
BS08-189-22  
22 cm/9"



**Kocher**

	Total length	Blade	
	cm	in.	mm
BS08-191-01	25	10	80 X 45
BS08-191-02	25	10	80 X 55
BS08-191-03	25	10	80 X 65



**Tuffier**  
BS08-193-23  
23 cm/9"

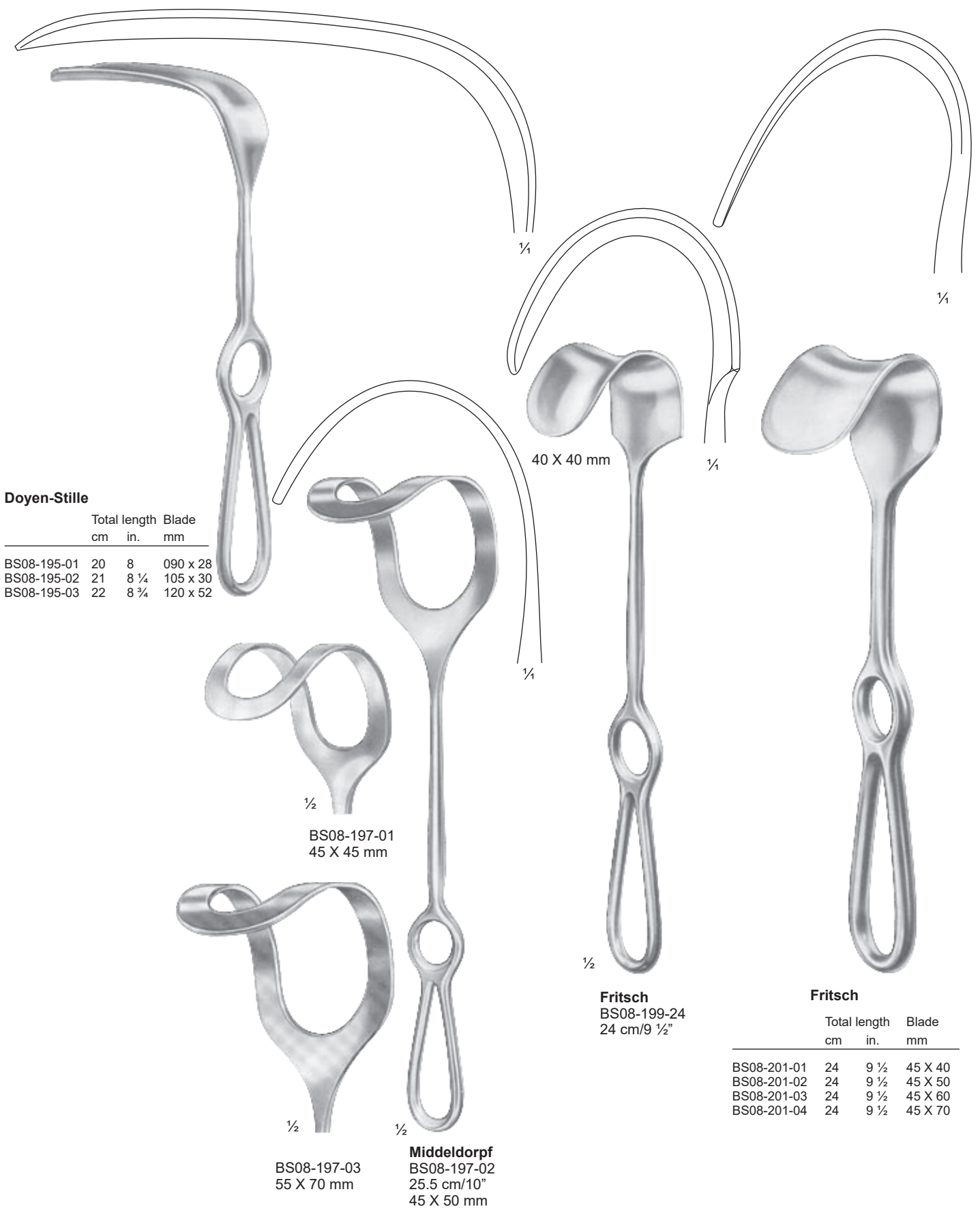

**Doyen-Style**

	Total length		Blade
	cm	in.	
BS08-195-01	20	8	090 x 28
BS08-195-02	21	8 ¼	105 x 30
BS08-195-03	22	8 ¾	120 x 52

BS08-197-01  
45 X 45 mm

BS08-197-03  
55 X 70 mm

**Middeldorpf**  
BS08-197-02  
25.5 cm/10"  
45 X 50 mm

40 X 40 mm

**Fritsch**  
BS08-199-24  
24 cm/9 ½"

**Fritsch**

	Total length		Blade
	cm	in.	
BS08-201-01	24	9 ½	45 X 40
BS08-201-02	24	9 ½	45 X 50
BS08-201-03	24	9 ½	45 X 60
BS08-201-04	24	9 ½	45 X 70





BS08-203-03  
19 cm / 7 3/4"



BS08-205-20  
28 cm / 11 1/4"

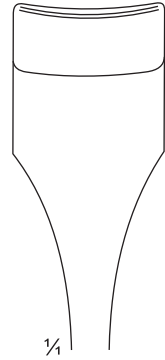

BS08-205-20

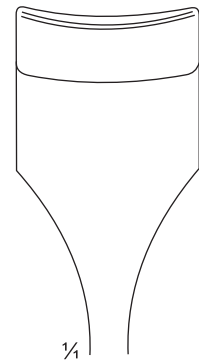

BS08-205-25

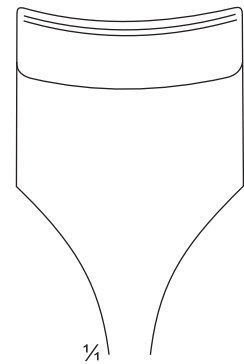

BS08-205-30

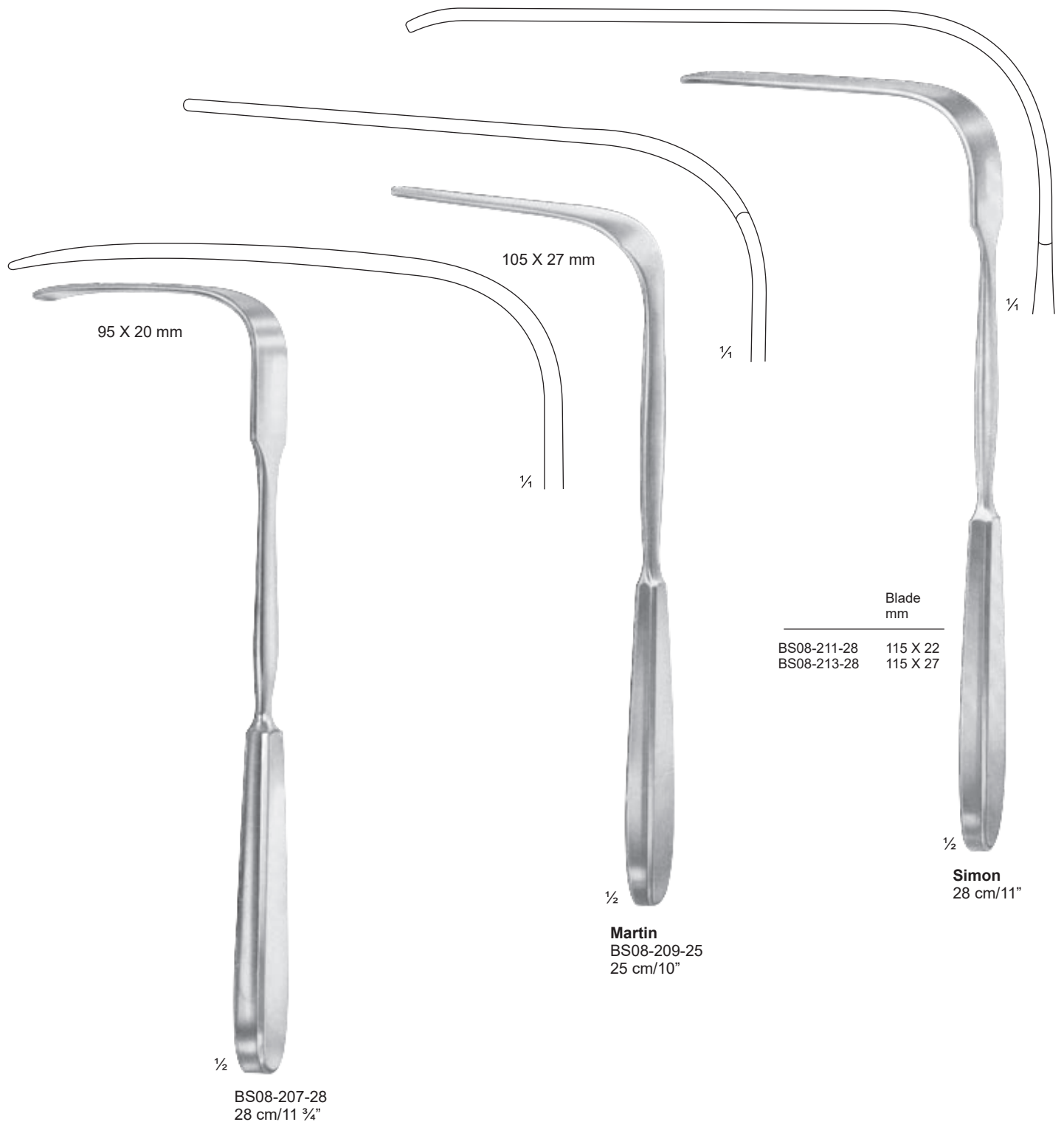



BS08-215-02  
75 X 90 mm

1/2

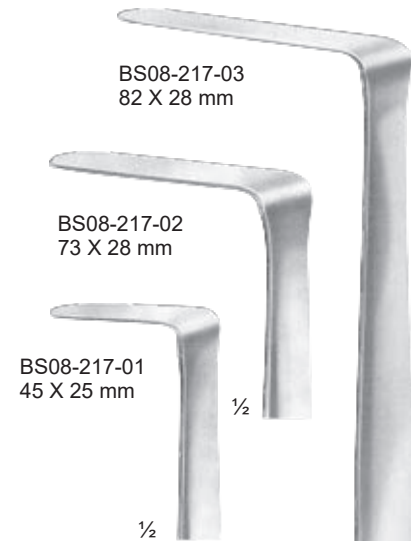

BS08-217-03  
82 X 28 mm

BS08-217-02  
73 X 28 mm

BS08-217-01  
45 X 25 mm

1/2

1/2

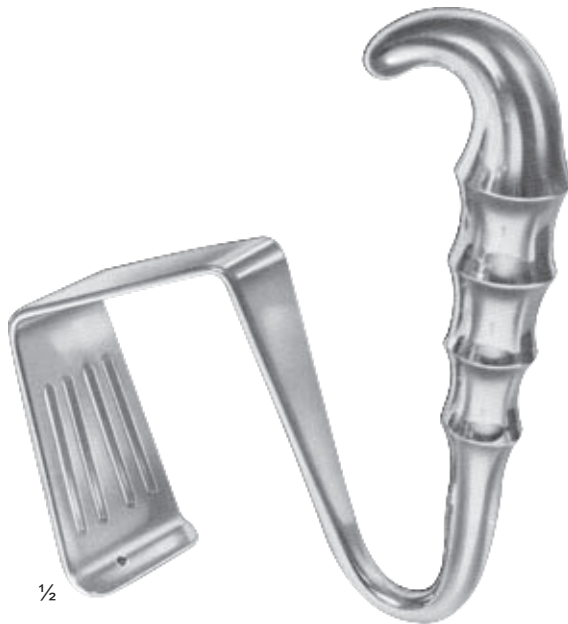

BS08-215-01  
75 X 50 mm

1/2

**Davidson**  
16 cm/6 1/4"  
(Scapula)

1/2

**Heaney**  
27 cm/10 1/2"

Retractors

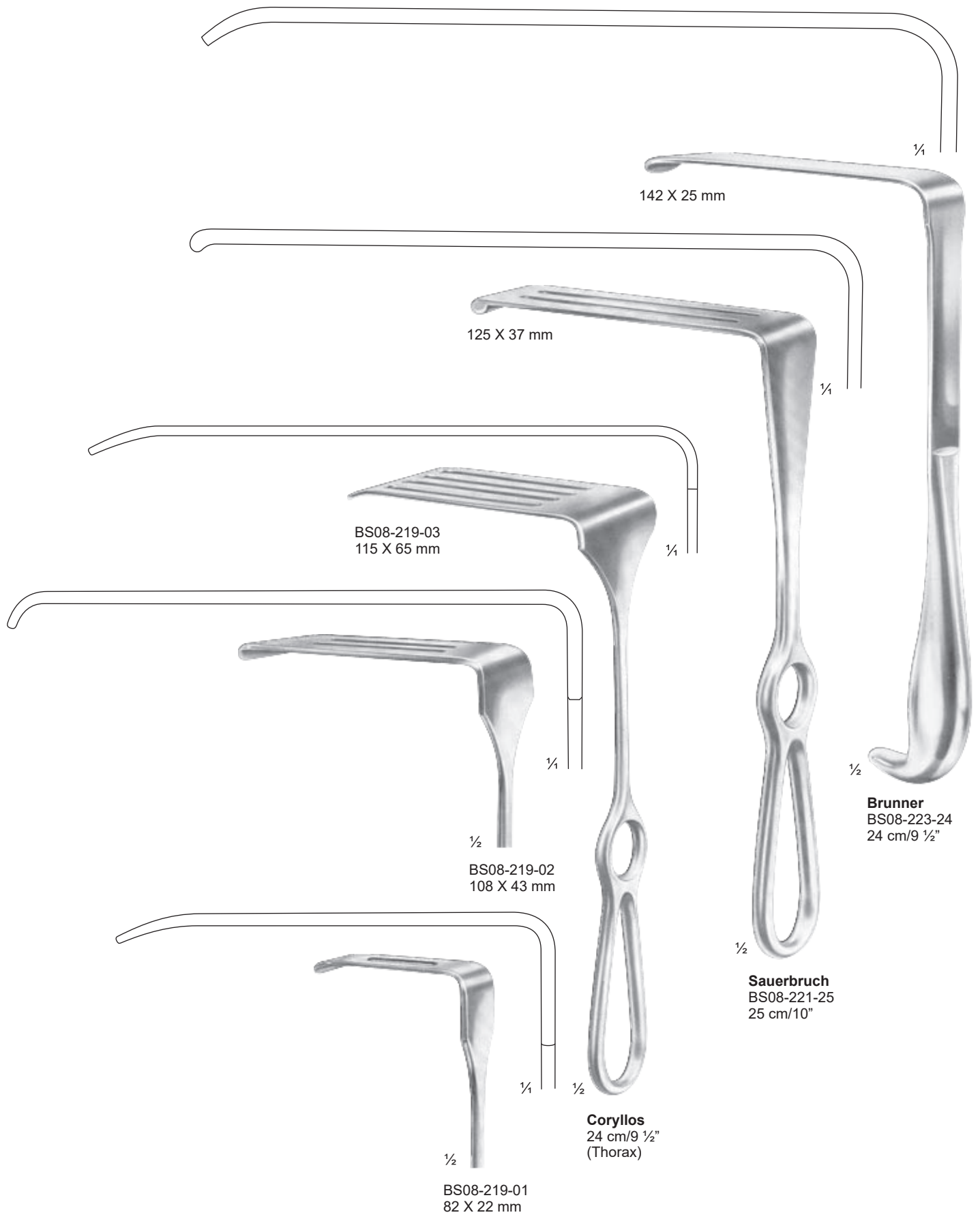

142 X 25 mm

125 X 37 mm

BS08-219-03  
115 X 65 mm

BS08-219-02  
108 X 43 mm

BS08-219-01  
82 X 22 mm

**Brunner**  
BS08-223-24  
24 cm/9 1/2"

**Sauerbruch**  
BS08-221-25  
25 cm/10"

**Coryllos**  
24 cm/9 1/2"  
(Thorax)



BS08-225-01  
45 X 15 mm

1/2

BS08-225-02  
60 X 23 mm

1/2

BS08-225-03  
75 X 20 mm

1/2

**Sauerbruch**  
22.5 cm/9"

Fig. 1 = 127 X 40 mm  
Fig. 2 = 127 X 62 mm

**Harrington**  
BS08-227-01 = Fig. 1  
BS08-227-02 = Fig. 2  
32 cm/12 1/2"  
(Splanchnicus)

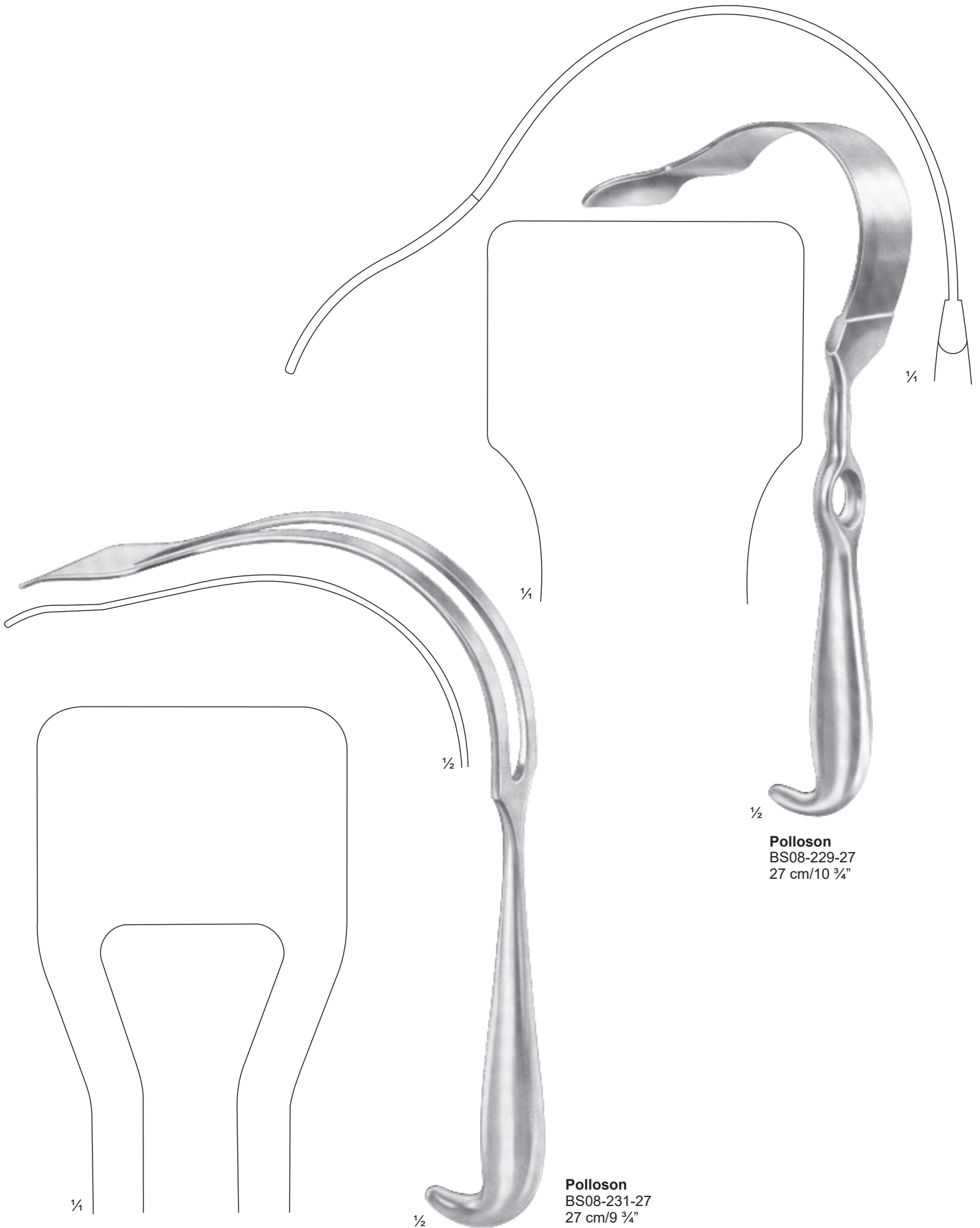

**Polloson**  
BS08-229-27  
27 cm/10  $\frac{3}{4}$ "

**Polloson**  
BS08-231-27  
27 cm/9  $\frac{3}{4}$ "



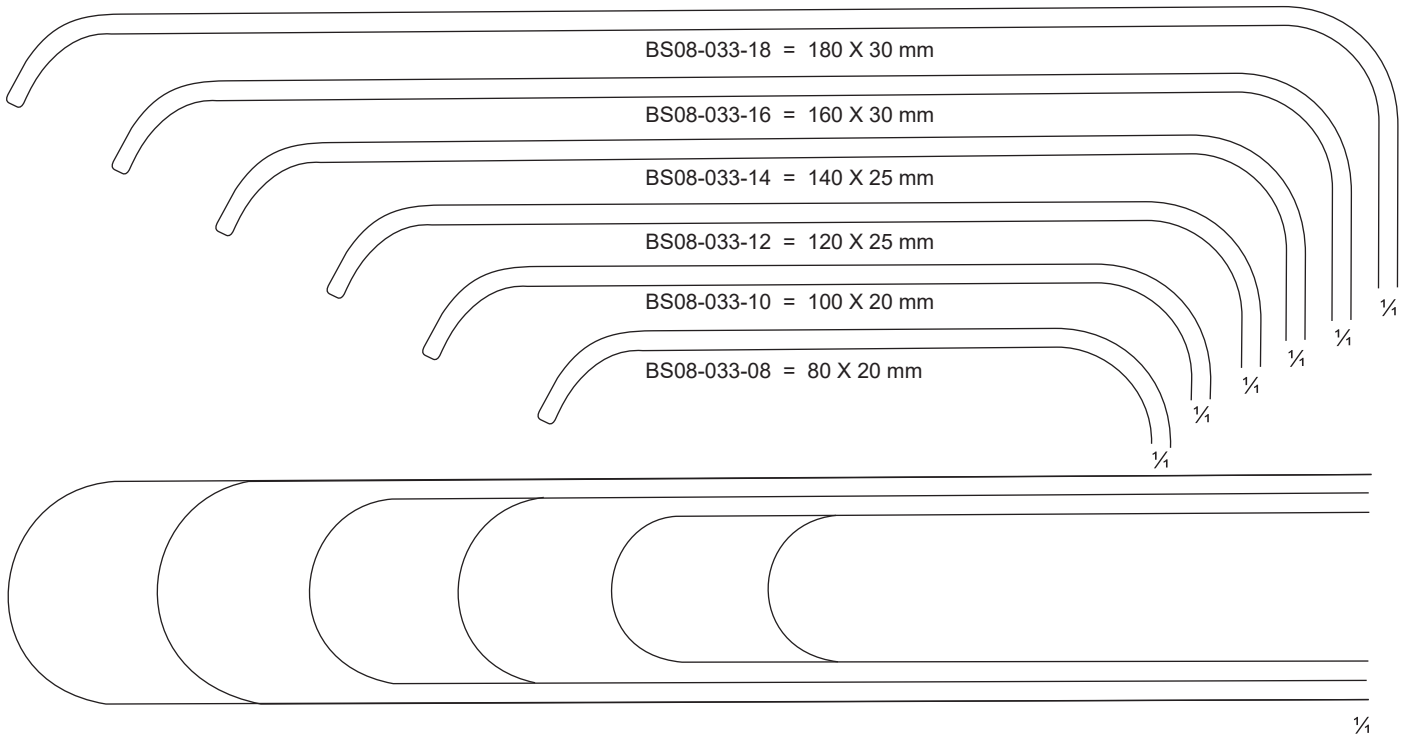

**Brunner**  
BS08-033-08 - 18  
25 cm/10"

1/2



115 x 27mm  
115 x 22mm

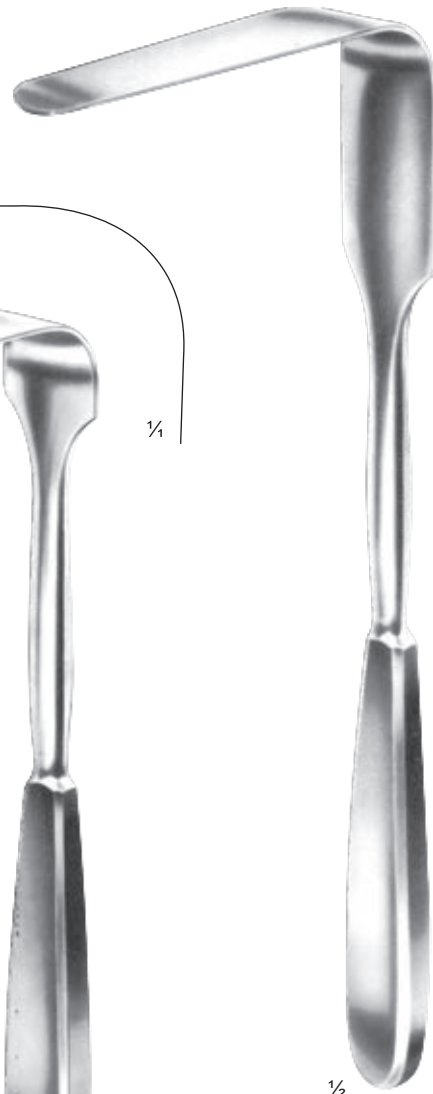

1/4

1/2

**Simon**  
BS08-239-22 = 115 x 22mm  
BS08-239-27 = 115 x 27mm  
28cm/11"

105 x 27mm



1/4

**Martin**  
BS08-237-27  
105 x 27mm  
26cm/10 1/4"

95 x 20mm



1/4

1/2

**Modell Tübingen**  
BS08-235-95  
95 x 20mm  
28cm/11"



BS08-241-18 180 x 30mm

BS08-241-16 160 x 30mm

BS08-241-14 140 x 30mm

BS08-241-13 130 x 30mm

BS08-241-12 120 x 25mm

BS08-241-10 100 x 25mm

BS08-241-08 80 x 20mm



1/2

**Brunner**  
25cm/10"



Retractors



1/2  
**Hösel**  
25cm/10"



BS08-243-62  
60 x 20 mm

1/4

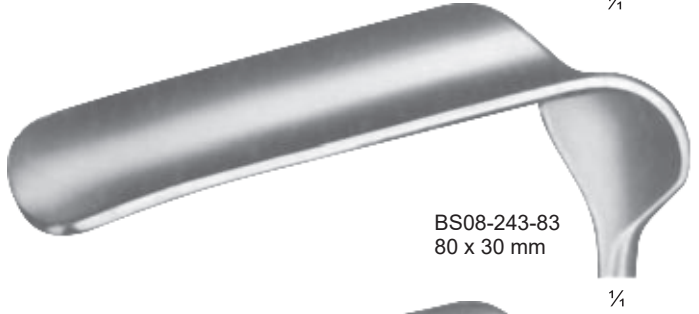

BS08-243-83  
80 x 30 mm

1/4



BS08-243-03  
100 x 30 mm

1/4



BS08-243-23  
120 x 30 mm

1/4



BS08-243-43  
140 x 30 mm

1/4



BS08-243-44  
140 x 40 mm

1/4





**Deaver**  
BS08-245-07  
30 cm/12"



**Deaver**  
BS08-245-08  
30 cm/12"



**Deaver**  
BS08-245-09  
30 cm/12"





**Koerte**  
BS08-249-28  
28 cm/11"  
rigid

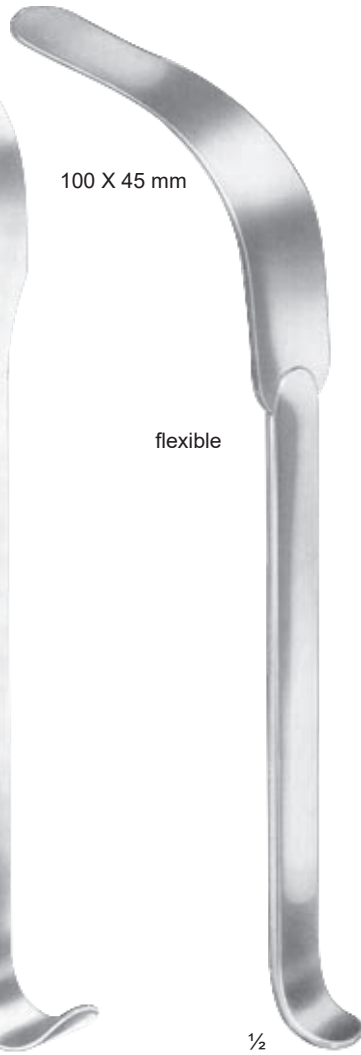

**Kuemmel**  
BS08-251-28  
28 cm/11"

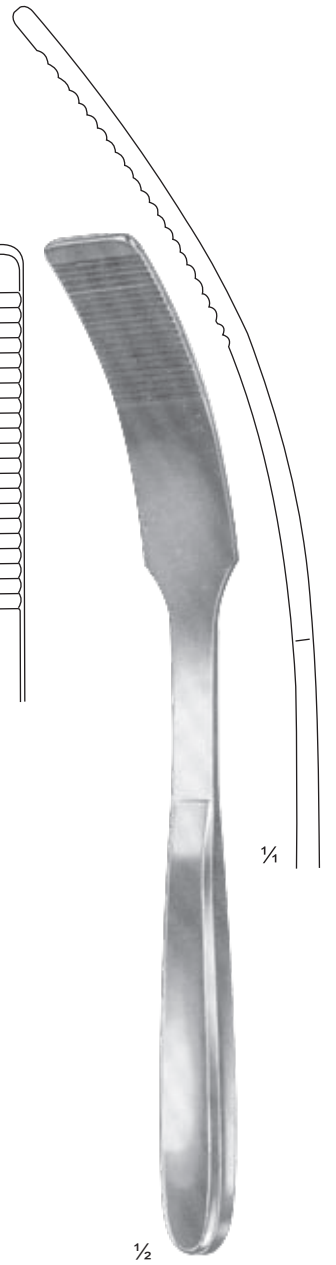
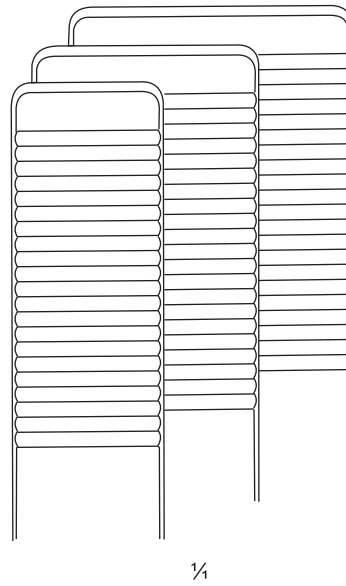

**Kader**  
BS08-253-20 = 20 mm  
BS08-253-30 = 30 mm  
BS08-253-40 = 40 mm  
27 cm/10 3/4"

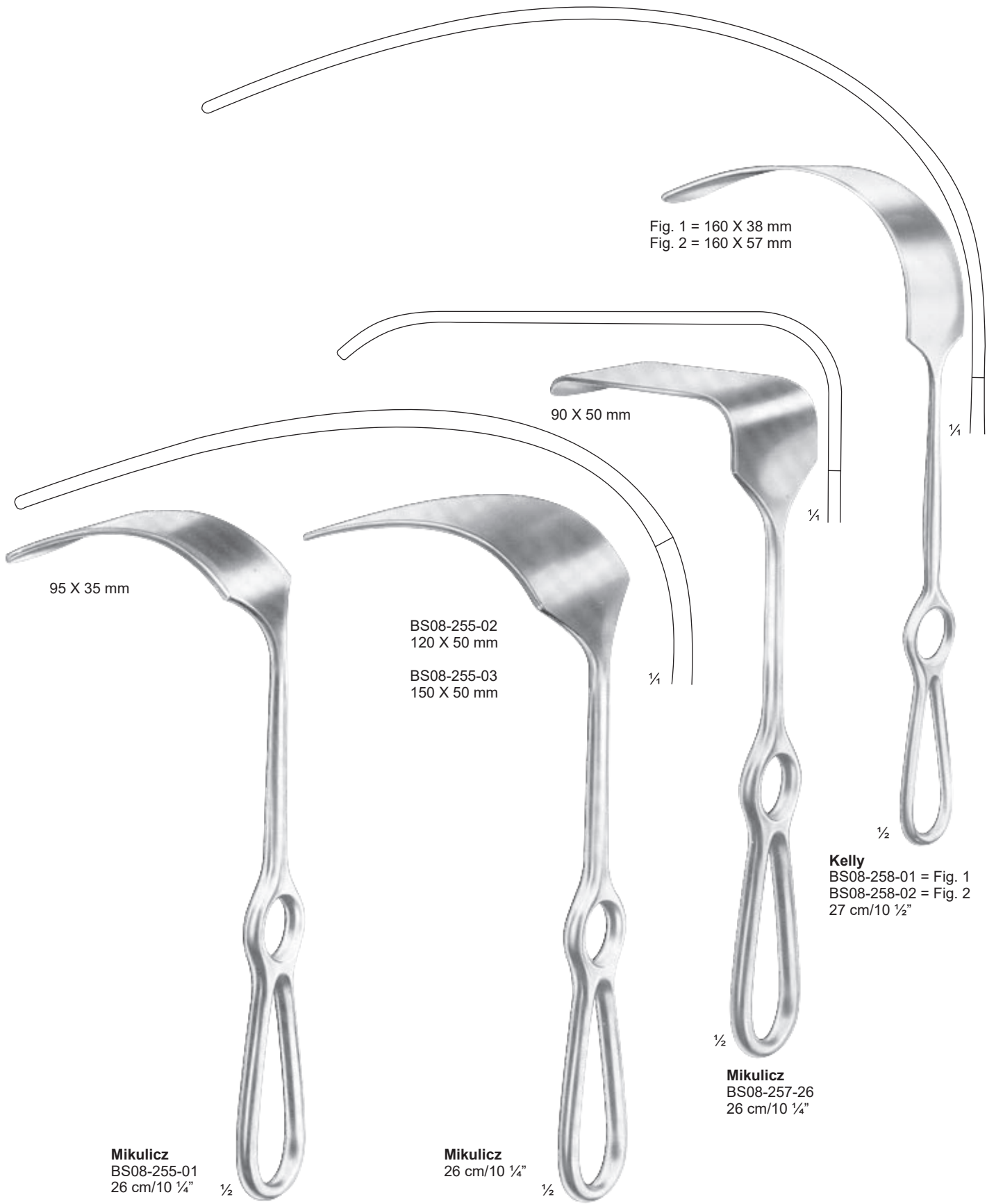

**Mikulicz**  
BS08-255-01  
26 cm/10 1/4" 1/2

**Mikulicz**  
26 cm/10 1/4" 1/2

**Mikulicz**  
BS08-257-26  
26 cm/10 1/4"

**Kelly**  
BS08-258-01 = Fig. 1  
BS08-258-02 = Fig. 2  
27 cm/10 1/2"



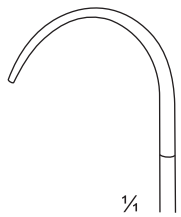

14 X 17 mm



BS08-259-01  
BS08-261-01  
21.5 cm/8 1/2"

20 X 22 mm



BS08-259-02  
BS08-261-02  
22 cm/8 3/4"

26 X 30 mm



BS08-259-03  
BS08-261-03  
23.5 cm/9 1/4"



**Middeldorpf**  
BS08-259-01-  
BS08-261-03



49 X 38 mm  
28 X 20 mm

Fig. 1 ▶

◀ Fig. 2

36 X 28 mm  
63 X 49 mm

**Richardson-Eastman**  
BS08-263-00 = Set 1 + 2  
BS08-263-01 = Fig. 1 = 26 cm/10 1/4"  
BS08-263-02 = Fig. 2 = 28 cm/11"



1/2

**Richardson**  
24 cm/9 1/2"

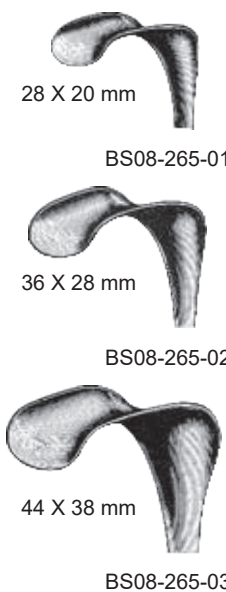

28 X 20 mm

BS08-265-01

36 X 28 mm

BS08-265-02

44 X 38 mm

BS08-265-03



1/2

**Richardson**  
BS08-267-24  
24 cm/9 1/2"



65 X 50 mm

1/2

**Kelly**  
BS08-269-26  
26 cm/10 1/4"



15-345-21 = 60 X 20 mm

1/4



1/2

BS08-271-01 = 35 X 7 mm



1/2

BS08-271-02 = 35 X 10 mm



1/2

BS08-271-03 = 35 X 15 mm

1/2

**Langenbeck**  
21 cm/8 1/4"

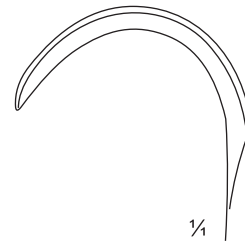

1/4



1/2

**Kocher**  
BS08-273-01 = 40 X 10 mm  
BS08-273-02 = 40 X 15 mm  
BS08-273-03 = 40 X 20 mm  
22 cm/8 3/4"



**Middeldorpf**  
BS08-275-01-  
BS08-275-03

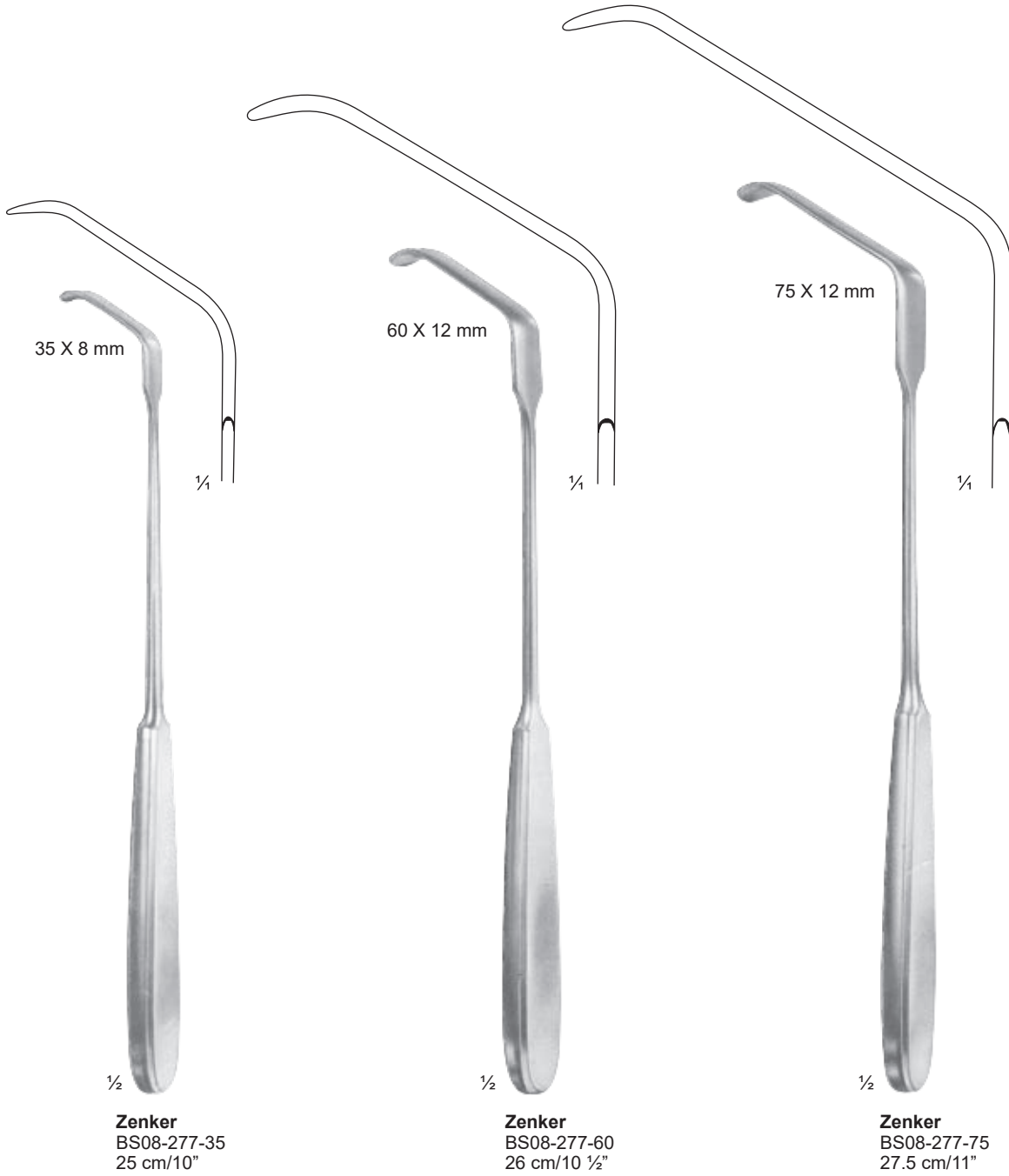

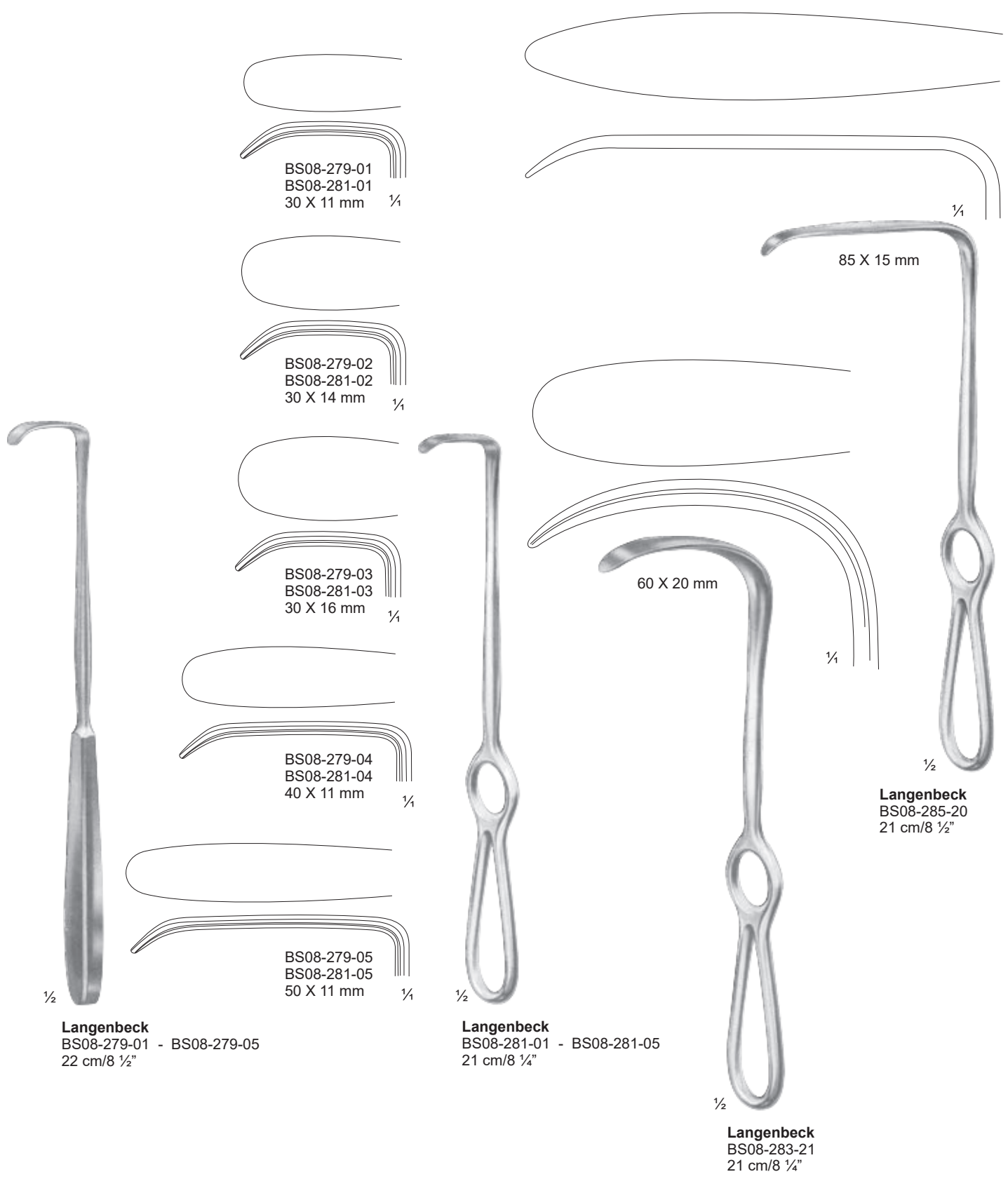

BS08-279-01  
BS08-281-01  
30 X 11 mm 1/4

BS08-279-02  
BS08-281-02  
30 X 14 mm 1/4

BS08-279-03  
BS08-281-03  
30 X 16 mm 1/4

BS08-279-04  
BS08-281-04  
40 X 11 mm 1/4

BS08-279-05  
BS08-281-05  
50 X 11 mm 1/4

85 X 15 mm

60 X 20 mm

**Langenbeck**  
BS08-285-20  
21 cm/8 1/2"

**Langenbeck**  
BS08-279-01 - BS08-279-05  
22 cm/8 1/2"

**Langenbeck**  
BS08-281-01 - BS08-281-05  
21 cm/8 1/4"

**Langenbeck**  
BS08-283-21  
21 cm/8 1/4"

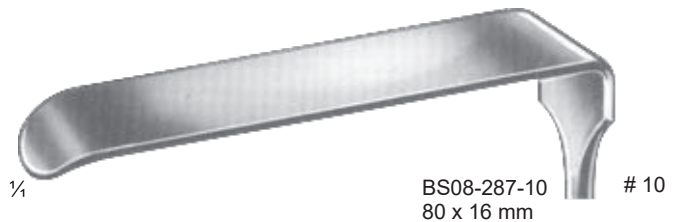
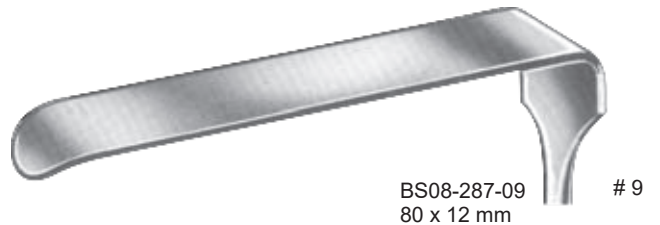
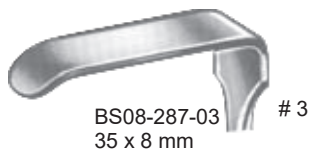
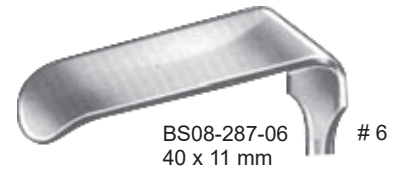

$\frac{1}{2}$   
**Kocher-Langenbeck**  
21.5cm/8  $\frac{1}{2}$ "

also available in special sizes

Retractors

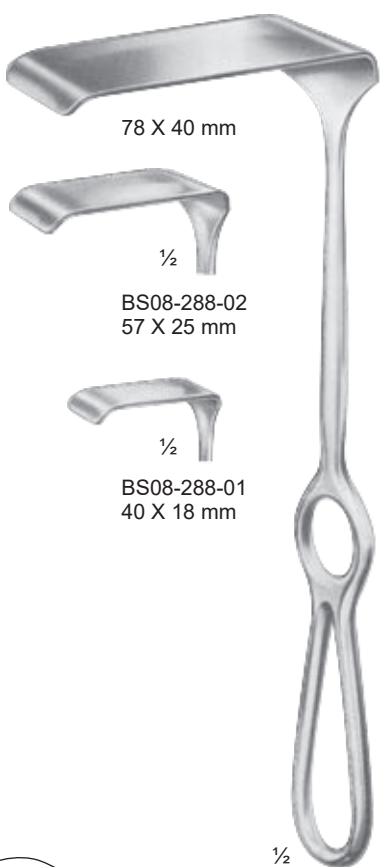

78 X 40 mm



1/2

BS08-288-02  
57 X 25 mm



1/2

BS08-288-01  
40 X 18 mm

1/2

BS08-288-03  
23 cm/9 1/4"

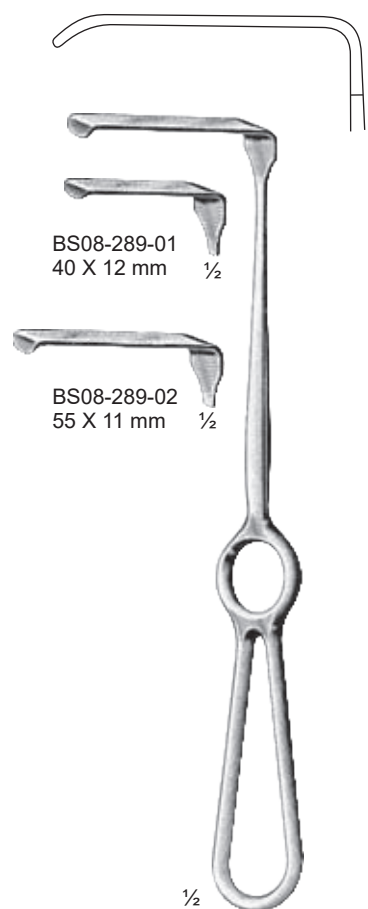

BS08-289-01  
40 X 12 mm 1/2

BS08-289-02  
55 X 11 mm 1/2

1/2

**Kocher**  
21 cm/8 1/4"

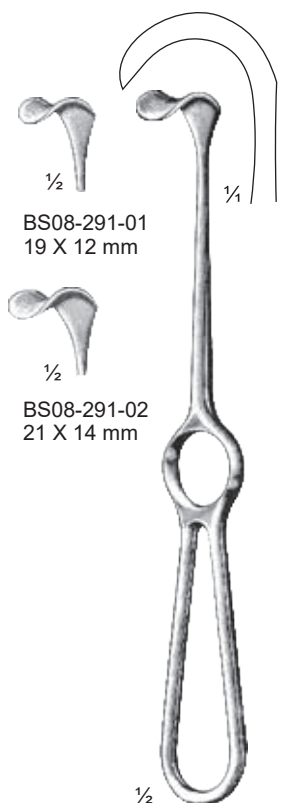

1/2

BS08-291-01  
19 X 12 mm

1/2

BS08-291-02  
21 X 14 mm

1/2

**Kocher**  
19 cm/7 1/2"



28 X 6 mm 1/4

1/2

**Lahey**  
BS08-293-19  
19 cm/7 1/2"



12 X 14 mm

1/2

**Little**  
BS08-295-20  
20 cm/8"





1/3

**Flexible**

- BS08-297-01 = 33 cm/13" 30 mm
- BS08-297-02 = 33 cm/13" 40 mm
- BS08-297-03 = 33 cm/13" 50 mm



1/3

**Haberer**

- BS08-299-00 = 20 cm/08" 17/25 mm
- BS08-299-01 = 28 cm/11" 25/30 mm
- BS08-299-02 = 30 cm/12" 37/45 mm



1/3

- BS08-301-12 = 200 X 12mm
- BS08-301-17 = 200 X 17mm
- BS08-301-25 = 250 X 25mm

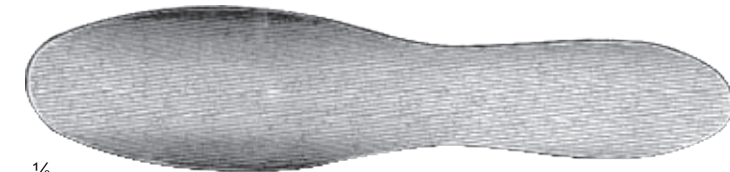

1/3

**Reverdin**

- BS08-303-29
- 29 cm/11 1/2"



1/3

**Reverdin**

- BS08-305-28
- 28 cm/11"



1/3

- BS08-307-28
- 28 cm/11"
- scoop 50X 45 mm

1/3

- BS08-309-33
- 33 cm/13"
- 85 mm ø
- 100 ccm



**BS08-311-03**  
12cm/4 3/4"

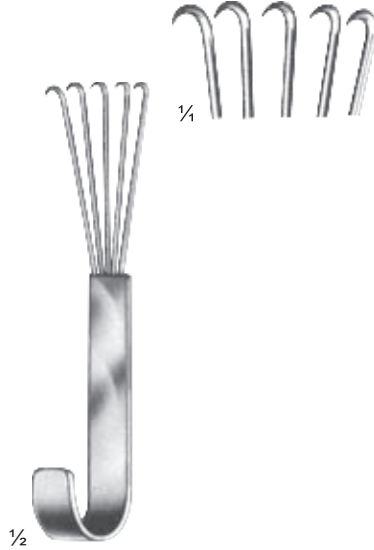

**BS08-311-05**  
12cm/4 3/4"

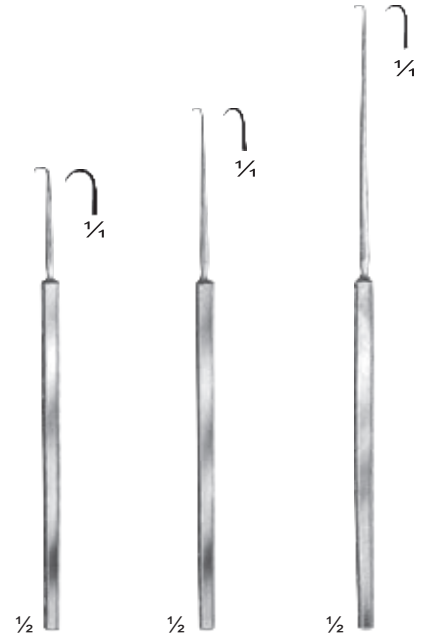

**O'Conner**  
BS08-313-12  
12cm/4 3/4"

**Cushing**  
BS08-315-14  
14cm/5 1/2"

**Cloward**  
BS08-317-16  
16.5cm/6 1/2"

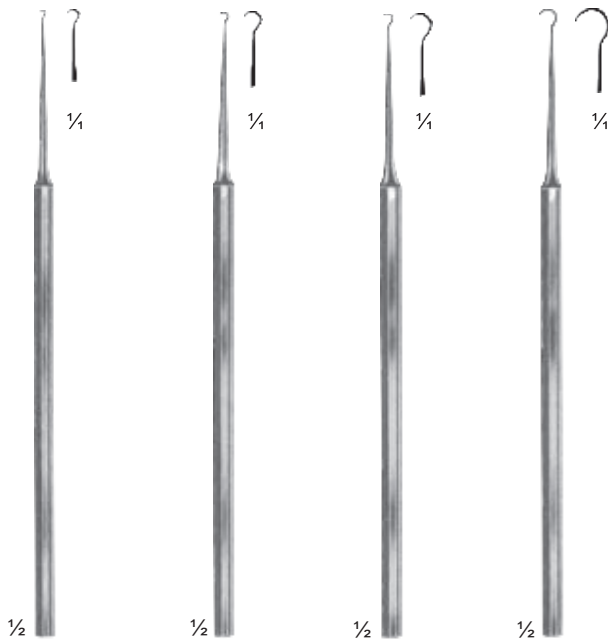

**Niro**  
BS08-319-01  
17cm/6 3/4"

**Niro**  
BS08-319-02  
17cm/6 3/4"

**Niro**  
BS08-319-03  
17cm/6 3/4"

**Niro**  
BS08-319-04  
17cm/6 3/4"



**BS08-321-06**  
13.5cm/5 1/4"

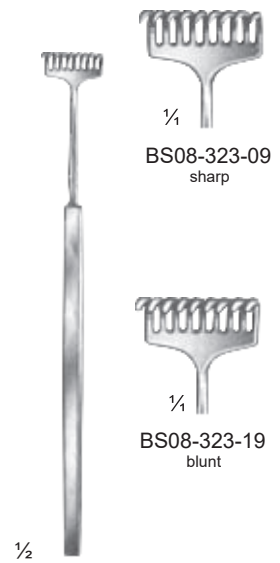

**Miller**  
13.5cm/5 1/2"

**BS08-323-09**  
sharp

**BS08-323-19**  
blunt



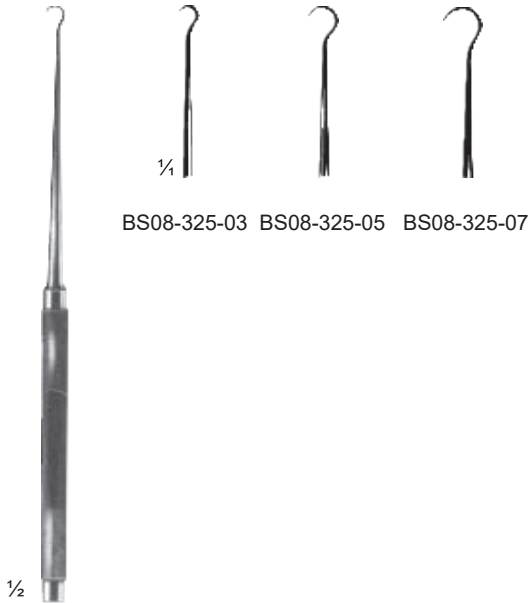

BS08-325-03 BS08-325-05 BS08-325-07

**Kleinert-Kutz**  
16cm/6 1/4"

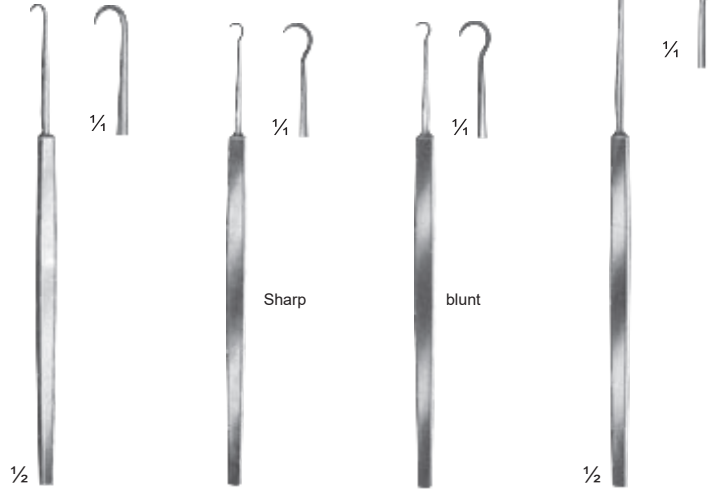

**Cushing**  
BS08-327-14  
14.5cm/5 3/4"

**Frazier**  
BS08-329-13  
13cm/5"

BS08-329-18  
18cm/7"

**Frazier**  
BS08-331-13  
13cm/5"

BS08-331-18  
18cm/7"

**Tonnis**  
BS08-333-15  
15cm/6"

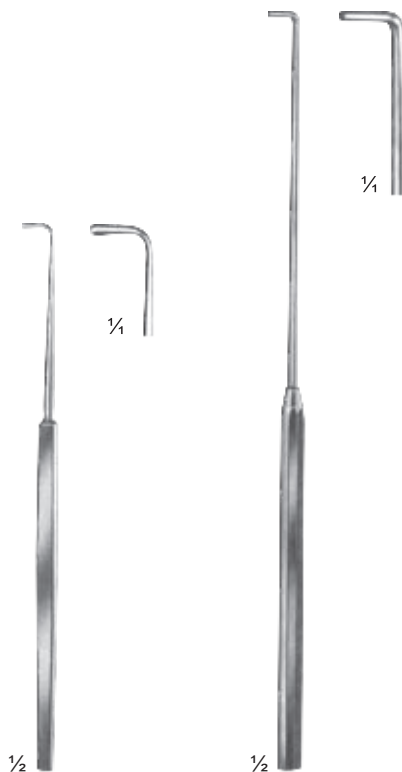

**Crile**  
BS08-335-14  
14.5cm/5 3/4"



**Crile**  
BS08-335-20  
20cm/8"

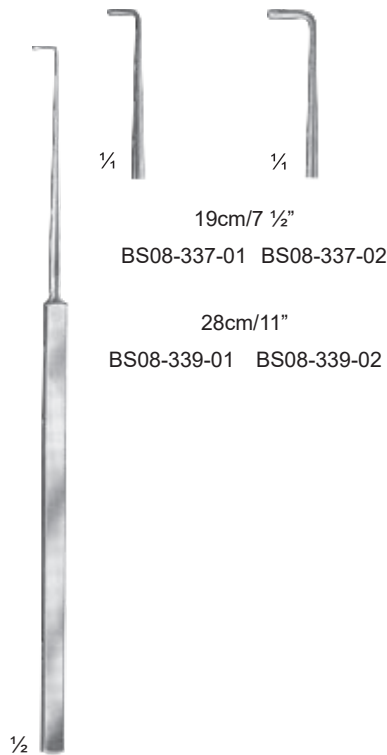

**Cushing**

19cm/7 1/2"  
BS08-337-01 BS08-337-02

28cm/11"  
BS08-339-01 BS08-339-02



**Adson**  
BS08-341-20  
20cm/8"



**Adson**  
BS08-343-20  
20cm/8"

Wound and Trachea Retractors, Mucous Hooks



**Jackson**  
BC08-345-13  
13cm/5"



**Jackson**  
BC08-345-15  
15cm/6"



**News**  
BC08-347-15  
15cm/6"



**Cottle**  
BC08-349-16  
16cm/6 1/4"



**Freer**  
BC08-351-15  
15cm/6"



**Iterson**  
BC08-353-16  
16cm/6 1/4"



**Iterson**  
BC08-355-16  
16cm/6 1/4"

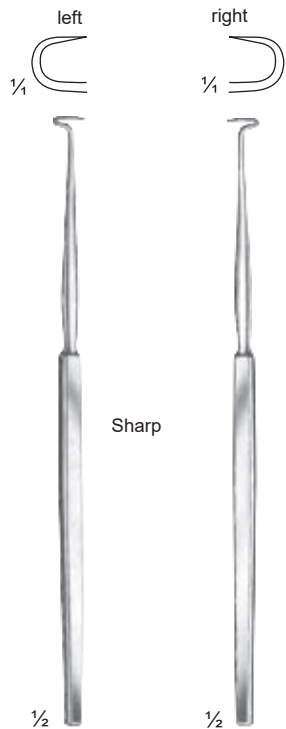

**Bose**  
BC08-357-01  
16cm/6 1/4"

**Bose**  
BC08-357-02  
16cm/6 1/4"

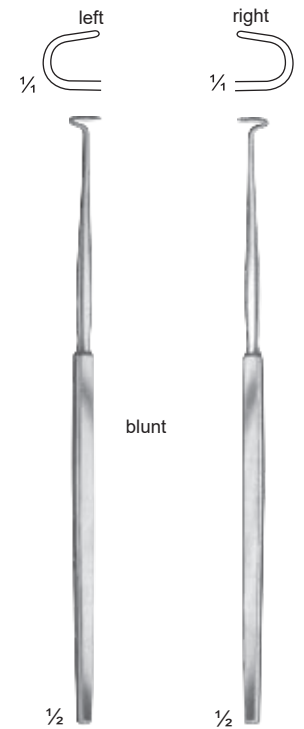

**Bose**  
BC08-357-11  
16cm/6 1/4"

**Bose**  
BC08-357-12  
16cm/6 1/4"

Wound and Trachea Retractors, Ear Hooklets



**Kilner (Barsky)**  
BS08-359-15  
15cm/6"



**Hartmann**  
BS08-361-16  
16cm/6 1/2"



**Gillies**  
BS08-363-01  
18cm/7"



**Gillies**  
BS08-363-02  
18cm/7"



**Gillies**  
BS08-363-52  
18cm/7"



**Sachs**  
BS08-365-21  
21cm/8 1/4"

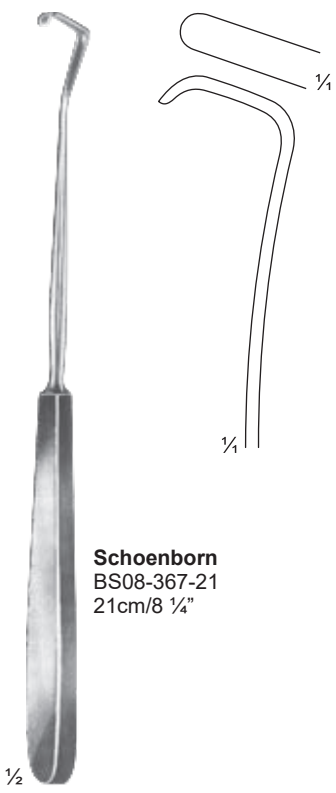

**Schoenborn**  
BS08-367-21  
21cm/8 1/4"



**Lukens**  
BS08-369-17  
17cm/6 3/4"



**Jackson**  
BS08-371-17  
17cm/6 3/4"



**Cope**  
BS08-373-18  
18cm/7"

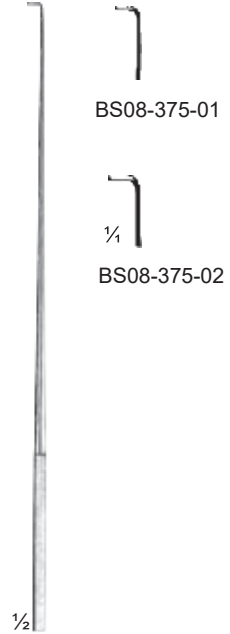

**Day**  
16cm/6 1/2"



**Allport**  
BS08-377-16  
16cm/6 1/2"



**Yankauer**  
BS08-379-15  
15cm/6"

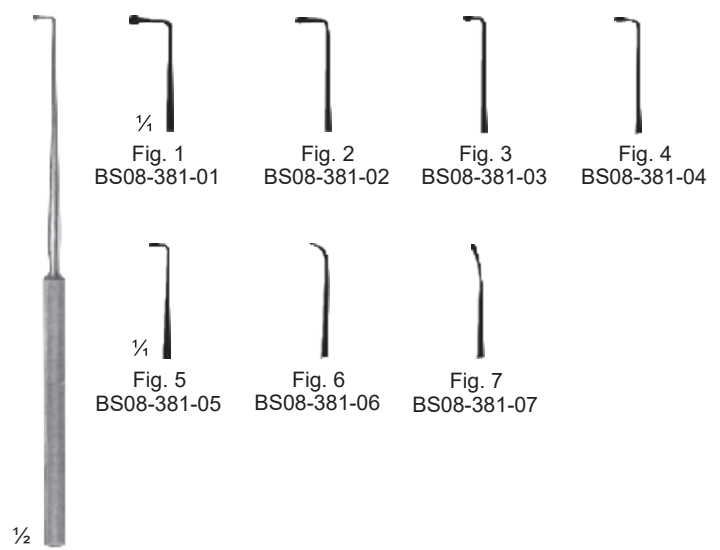

**Wagener**  
14cm/5 1/2"



**Lucae**  
14 cm/5 1/2"



**Knapp**  
BS08-385-13  
13cm/5"



**Rollet**  
BS08-387-02  
12.5 cm/4 3/4"



**Rollet (Blair)**  
BS08-387-04  
13.5 cm/5"

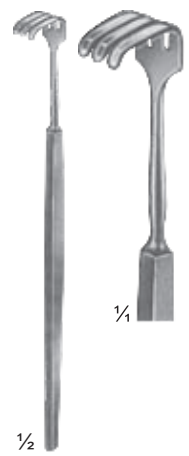

**Paul**  
BS08-389-03  
12.5 cm/4 3/4"

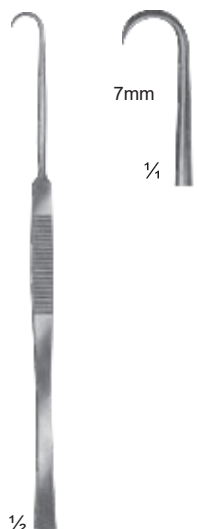

**Bergmann**  
BS08-391-07  
14cm/5 1/2"

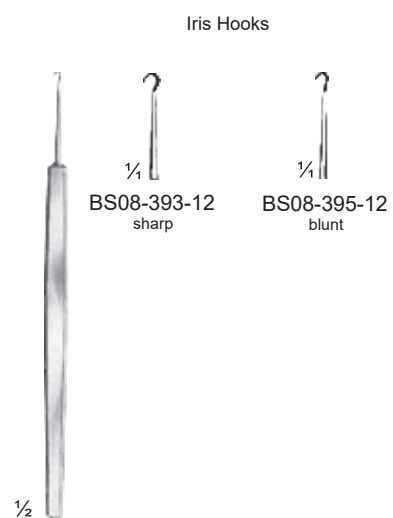

**Graefe (Tyrell)**  
12cm/4 3/4"

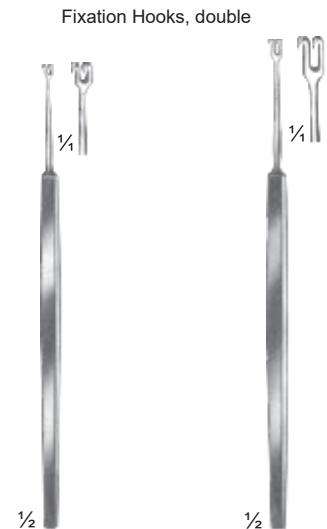

**Guthrie**  
BS08-397-01  
12cm/4 3/4"

**Guthrie**  
BS08-399-02  
13cm/5"



**Emmet**  
22cm/8 3/4"



**Simon**  
BS08-403-01  
22cm/8 3/4"

**Simon**  
BS08-403-02  
22cm/8 3/4"

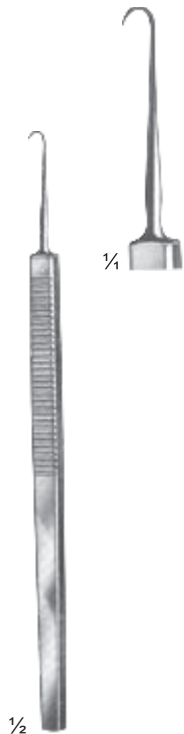

**O'Connor**  
BS08-405-16  
16cm/6 1/4"



**Guthrie**  
16cm/6 1/4"



BS08-407-01



BS08-407-02



**Graefe**  
16 cm/6 1/4"



BS08-409-01  
sharp



BS08-409-11  
blunt



16cm/6 1/4"



BS08-411-01



BS08-411-02



BS08-411-03



BS08-411-04



1/2

BS08-413-14  
14cm/5 1/2"



BS08-415-01



BS08-415-02



BS08-415-03



1/2

**Cushing**  
14.5 cm/5 1/2"



**Volkmann**  
23 cm/9"

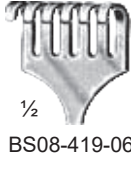
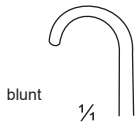
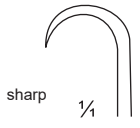

16 cm/6 1/4"



**Cushing**  
20 cm/8"

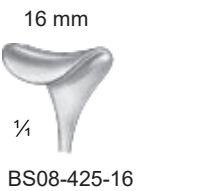
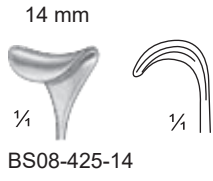
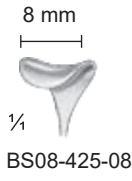

**Cushing**  
24 cm/9 1/2"

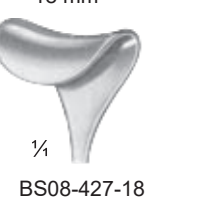
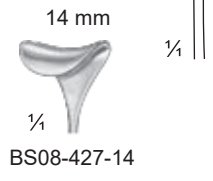

Retractor



**Mini-Langenbeck**  
16 cm/6 1/4"

10 x 6 mm



BS08-429-10

20 x 6 mm



BS08-429-20

17 x 5 mm



BS08-429-17

22 x 8 mm



BS08-429-22

14 x 8 mm

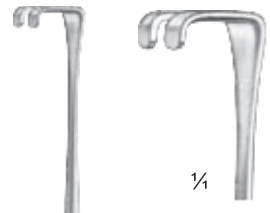

BS08-431-16

16 cm/6 1/4"

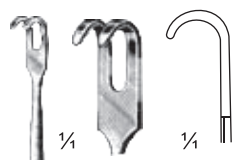

BS08-433-02  
13.5 cm/5 1/4"



**Klapp**  
17.5 cm/7"



BS08-435-02



BS08-435-03



BS08-437-01



BS08-437-02

toothed



**Strandell-Still**  
19 cm/7 1/2"





Retractor

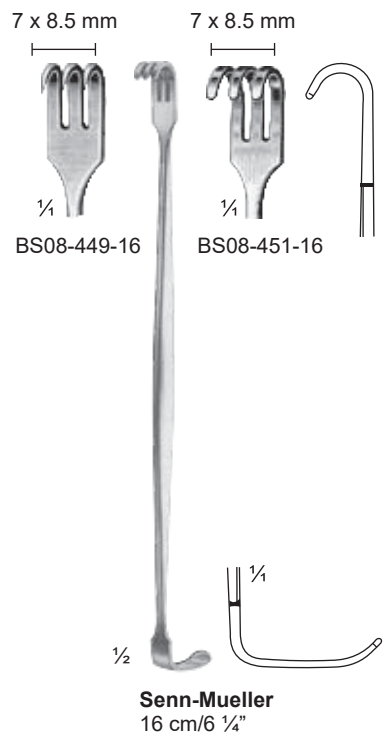
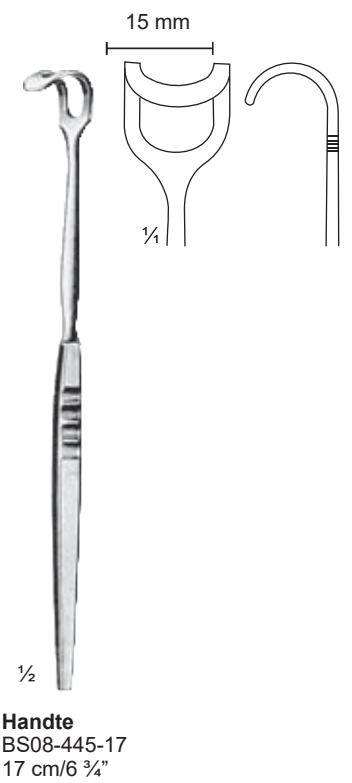
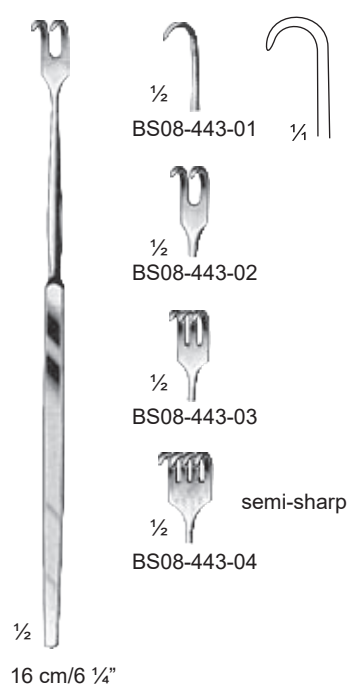
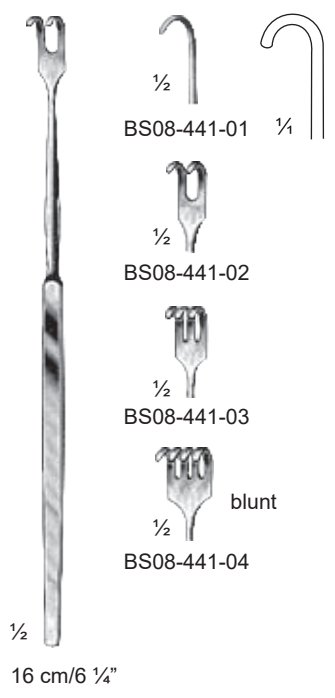
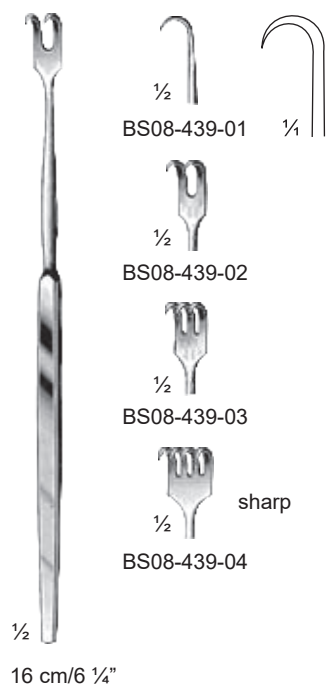

Micro retractor with saddle blade, buttoned

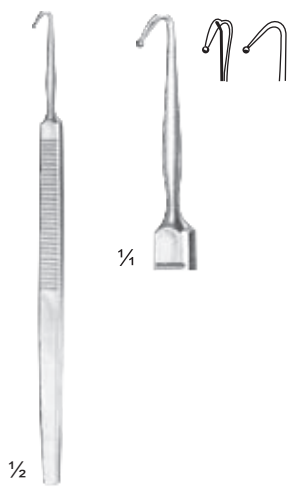

BS08-455-12  
12 cm/4 1/2"

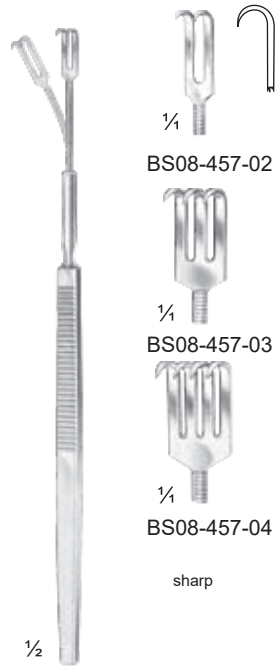

BS08-457-02  
BS08-457-03  
BS08-457-04

sharp flexible blunt

16 cm/6 1/4"



BS08-459-02  
BS08-459-03  
BS08-459-04

blunt

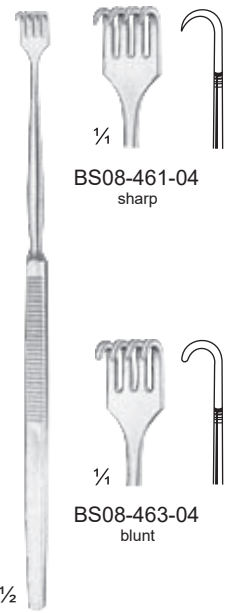

BS08-461-04 sharp

BS08-463-04 blunt

16 cm/6 1/4"



17 cm/6 3/4"



BS08-465-01  
BS08-465-02  
BS08-465-03  
BS08-465-04  
BS08-465-06

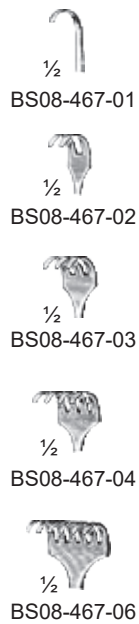
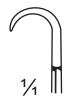

BS08-467-01  
BS08-467-02  
BS08-467-03  
BS08-467-04  
BS08-467-06

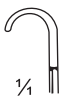

16 cm/6 1/4"

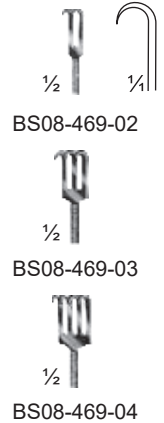

BS08-469-02  
BS08-469-03  
BS08-469-04

flexible

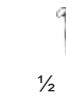

BS08-471-02  
BS08-471-03  
BS08-471-04



Retractor

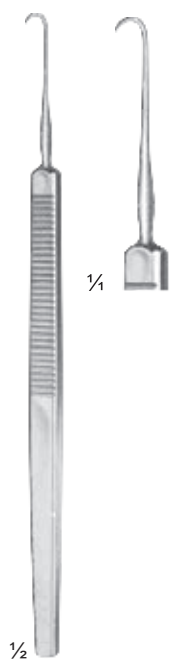

**O'Connor**  
BS08-473-16  
16 cm/6 1/4"



**Graefe**  
16 cm/6 1/4"



BS08-475-01  
sharp



BS08-475-02  
blunt



1/4  
BS08-477-01



1/4  
BS08-477-02



1/4  
BS08-477-03



1/4  
BS08-477-04

16 cm/6 1/4"



BS08-479-16  
16 cm/6 1/4"



**Desmarres**  
16 cm/6 1/4"



BS08-481-08



BS08-481-14



BS08-481-10



BS08-481-16



BS08-481-12



BS08-481-18



16 cm/6 1/4"

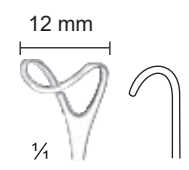

BS08-483-12

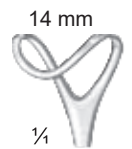

BS08-483-14

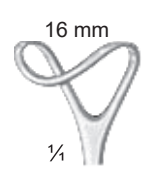

BS08-483-16

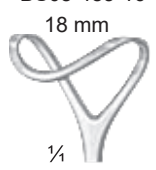

BS08-483-18



Retractor

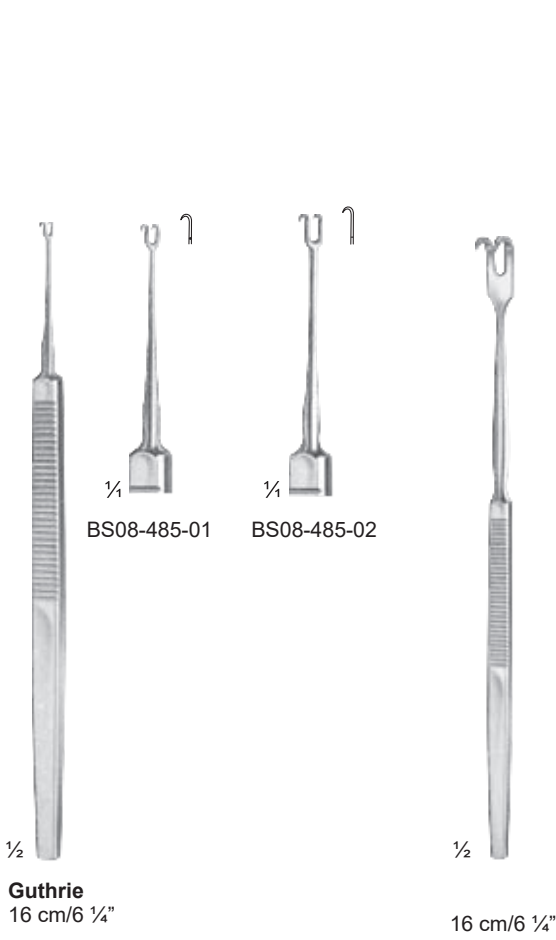

$\frac{1}{2}$   
**Guthrie**  
 16 cm/6  $\frac{1}{4}$ "

$\frac{1}{4}$  BS08-485-01  
 $\frac{1}{4}$  BS08-485-02  
 $\frac{1}{2}$  16 cm/6  $\frac{1}{4}$ "

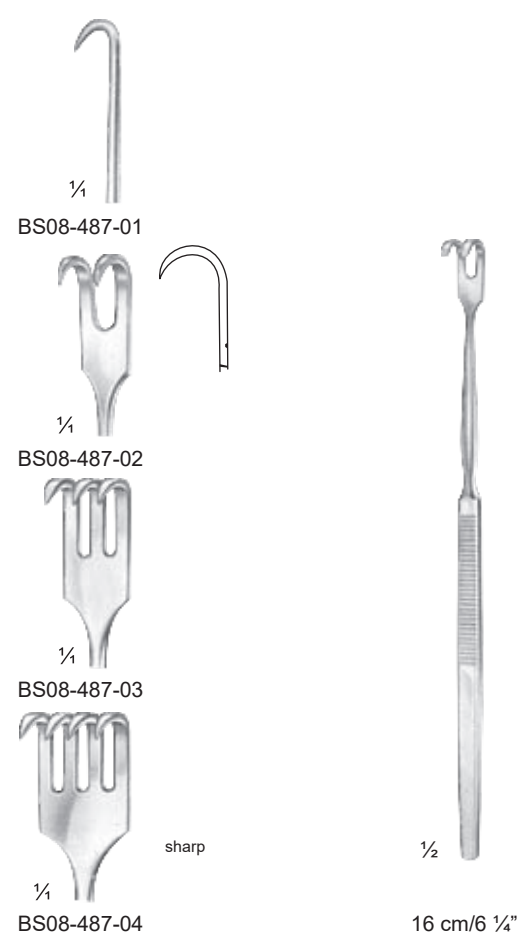

$\frac{1}{4}$  BS08-487-01  
 $\frac{1}{4}$  BS08-487-02  
 $\frac{1}{4}$  BS08-487-03  
 $\frac{1}{4}$  BS08-487-04  
 sharp  
 $\frac{1}{2}$  16 cm/6  $\frac{1}{4}$ "

$\frac{1}{4}$  BS08-489-01  
 $\frac{1}{4}$  BS08-489-02  
 $\frac{1}{4}$  BS08-489-03  
 $\frac{1}{4}$  BS08-489-04  
 blunt  
 $\frac{1}{2}$  16 cm/6  $\frac{1}{4}$ "

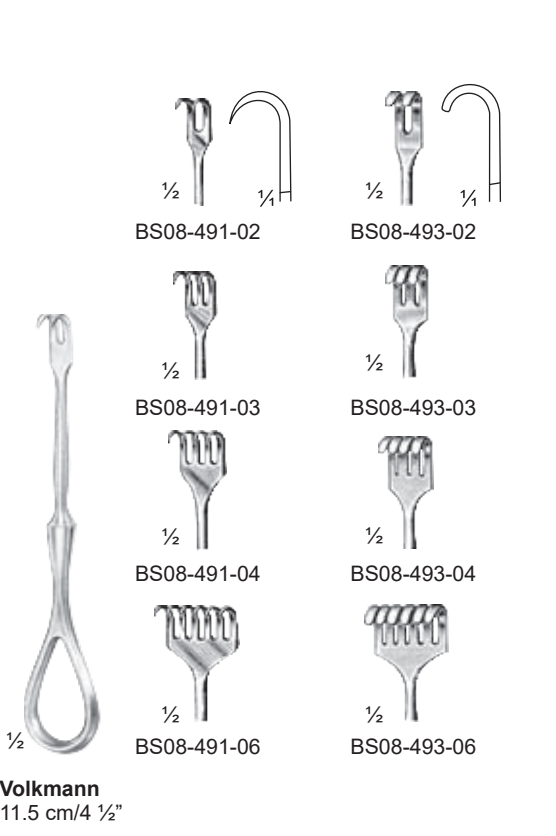

$\frac{1}{2}$  BS08-491-02  
 $\frac{1}{2}$  BS08-491-03  
 $\frac{1}{2}$  BS08-491-04  
 $\frac{1}{2}$  BS08-491-06  
 $\frac{1}{2}$  11.5 cm/4  $\frac{1}{2}$ "

$\frac{1}{4}$  BS08-493-02  
 $\frac{1}{2}$  BS08-493-03  
 $\frac{1}{2}$  BS08-493-04  
 $\frac{1}{2}$  BS08-493-06

**Volkmann**  
 11.5 cm/4  $\frac{1}{2}$ "

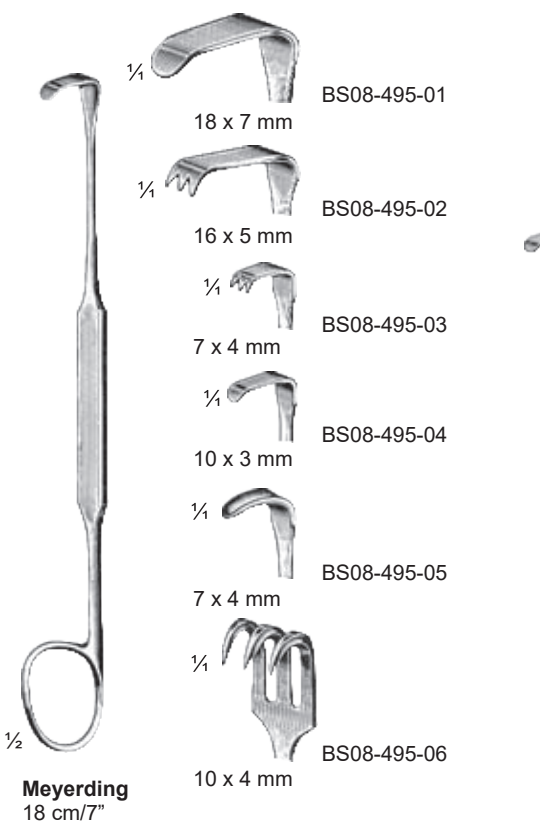

$\frac{1}{4}$  BS08-495-01  
 18 x 7 mm  
 $\frac{1}{4}$  BS08-495-02  
 16 x 5 mm  
 $\frac{1}{4}$  BS08-495-03  
 7 x 4 mm  
 $\frac{1}{4}$  BS08-495-04  
 10 x 3 mm  
 $\frac{1}{4}$  BS08-495-05  
 7 x 4 mm  
 $\frac{1}{4}$  BS08-495-06  
 10 x 4 mm  
 $\frac{1}{2}$  18 cm/7"

**Meyerdig**  
 18 cm/7"

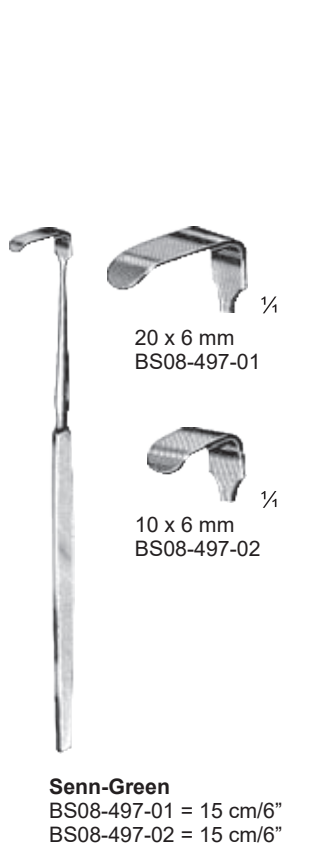

$\frac{1}{4}$  BS08-497-01  
 20 x 6 mm  
 $\frac{1}{4}$  BS08-497-02  
 10 x 6 mm  
 $\frac{1}{4}$  BS08-497-02

**Senn-Green**  
 BS08-497-01 = 15 cm/6"  
 BS08-497-02 = 15 cm/6"

Retractor

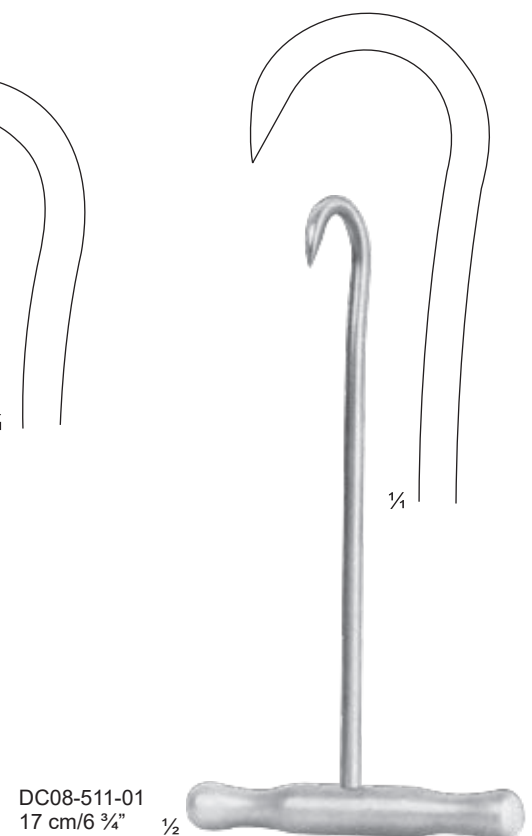
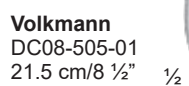
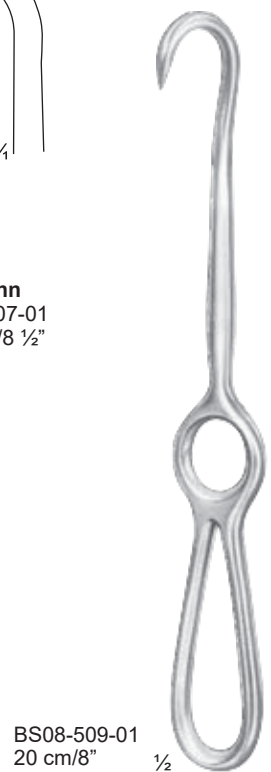
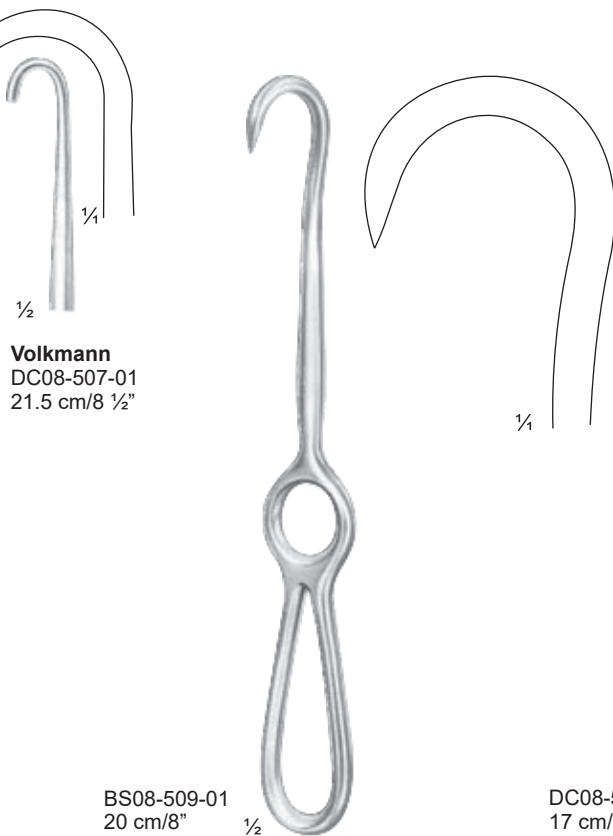
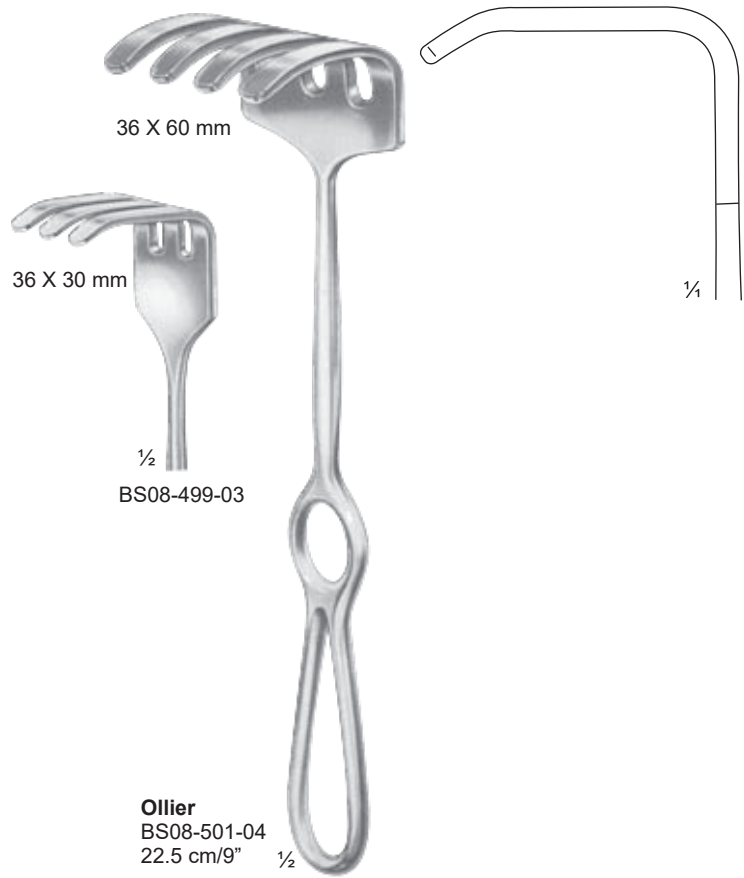



**Volkmann**  
21.5 cm/8 1/2"



**Kocher**  
22 cm/8 3/4"

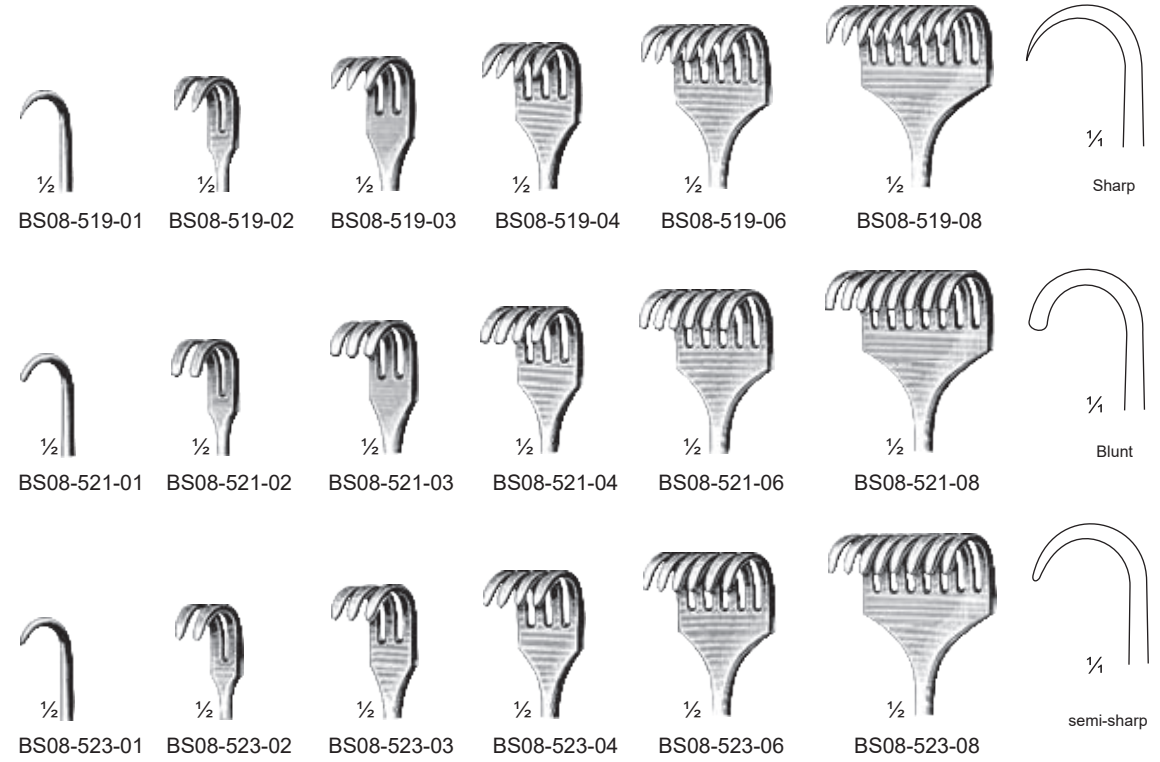



BS08-525-07  
27 cm/10 3/4"

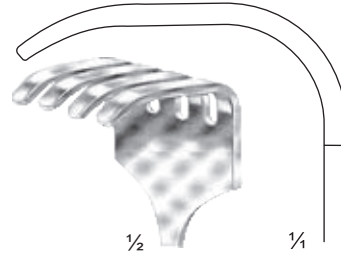

BS08-527-04  
40 X 40 mm

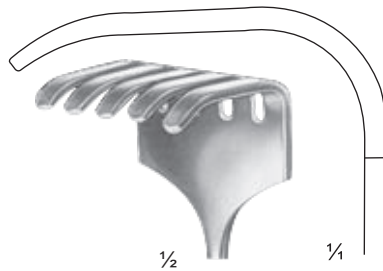

BS08-529-05  
45 X 50 mm

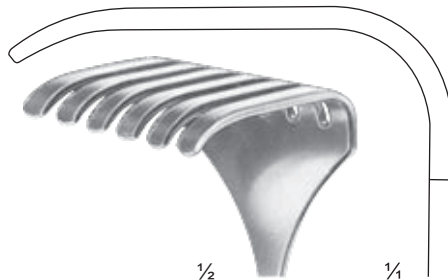

BS08-531-06  
50 X 60 mm

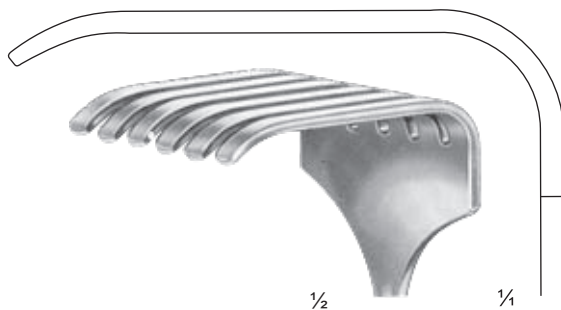

BS08-533-07  
70 X 70 mm



Israel  
25 cm/10"

