

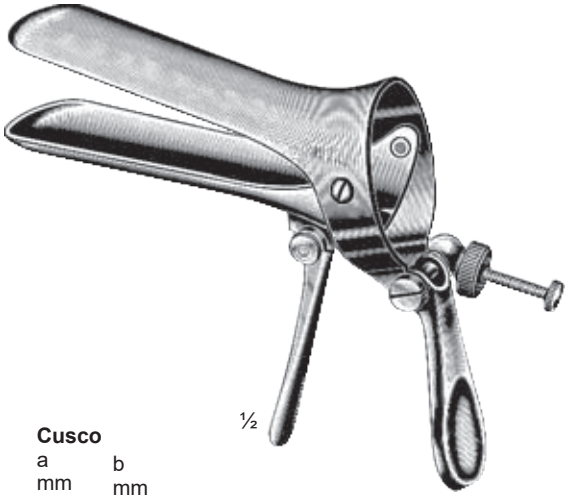

# Gyneacology

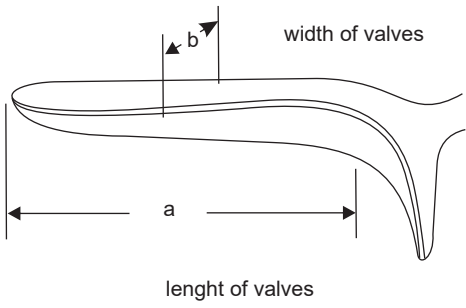

Scheme of dimension for specula



**Cusco**

a mm	b mm	
75	32	BS09-003-01
85	35	BS09-003-02
100	35	BS09-003-03



**Cusco**

a mm	b mm	
75	17	BS09-005-01

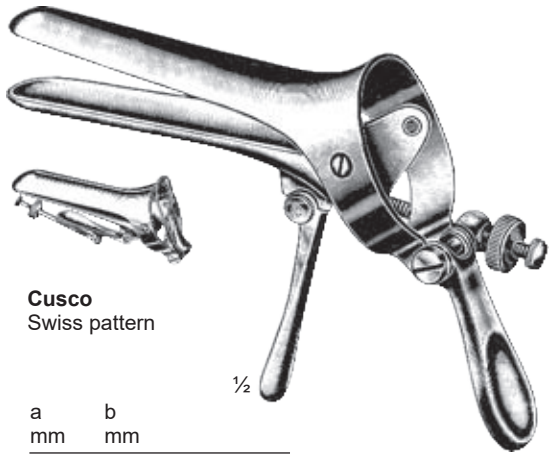

**Cusco**  
Swiss pattern

a mm	b mm	
80	22	BS09-007-01
100	25	BS09-007-02
105	27	BS09-007-03

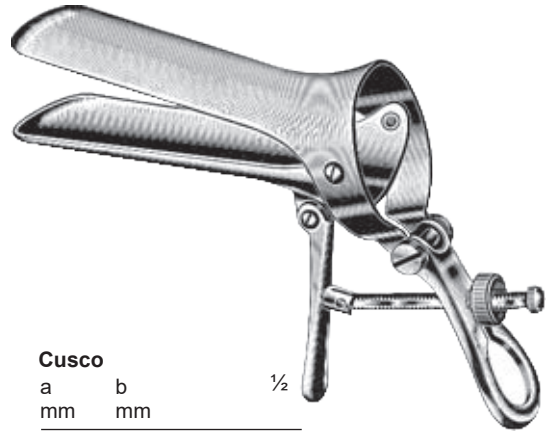

**Cusco**

a mm	b mm	
75	32	BS09-009-01
85	35	BS09-009-02
100	37	BS09-009-03

- BS09-003-01 - Vaginal Specula, with lateral ratchet, with folding handles
- BS09-005-01 - ditto, conical shape, virgin size
- BS09-007-01 - BS09-007-03 - Swiss pattern, narrow, with lateral ratchet, with folding handles
- BS09-009-01 - BS09-009-03 - with ratchet at the folding handles



**Collin**

a mm	b mm	
65	20	BS09-011-01

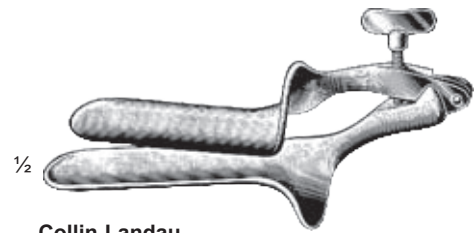

**Collin-Landau**

a mm	b mm	
100	35	BS09-015-02

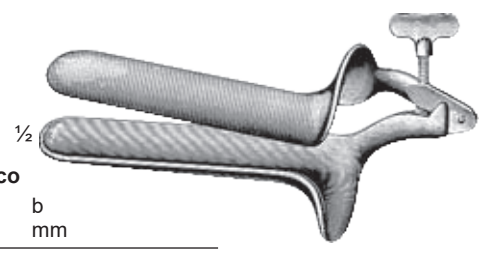

**Cusco**

a mm	b mm	
85	30	BS09-013-01
100	35	BS09-013-02
110	40	BS09-013-03

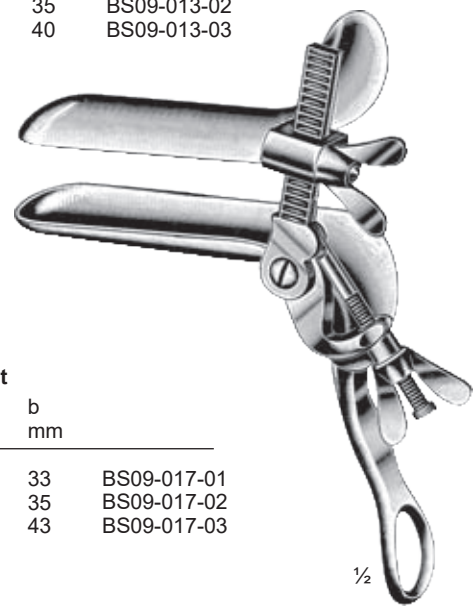

**Trelat**

a mm	b mm	
85	33	BS09-017-01
95	35	BS09-017-02
115	43	BS09-017-03

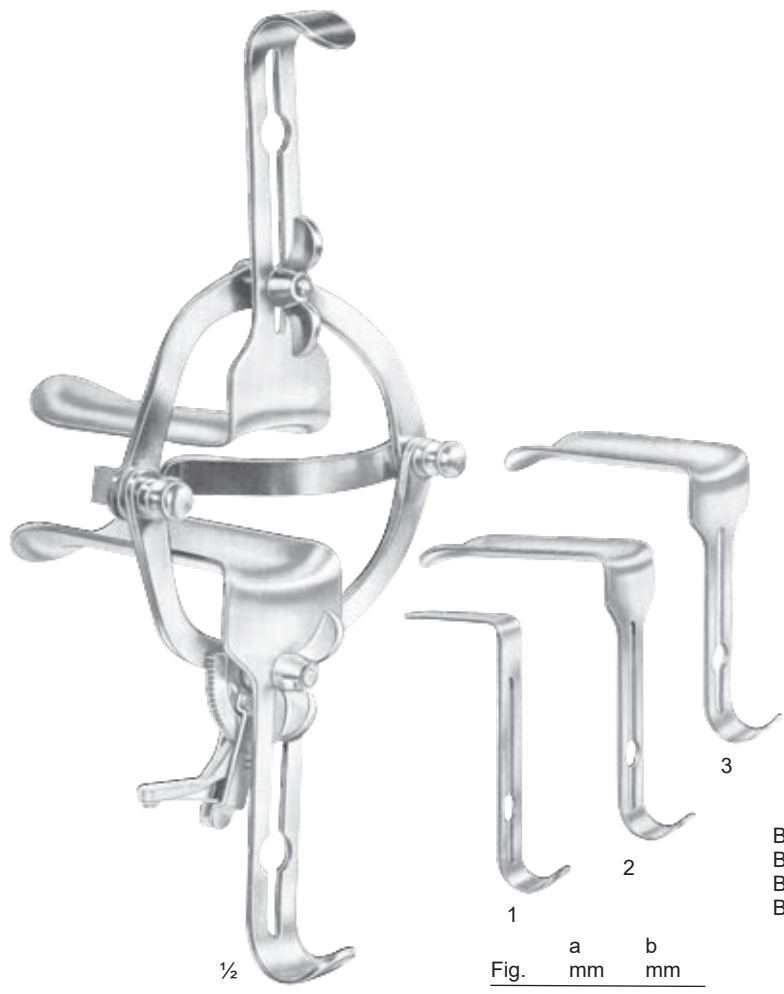

**O'Sullivan- O'Connor**  
BS09-019-00

Fig.	a mm	b mm
1	45	17
2	90	37
3	90	45

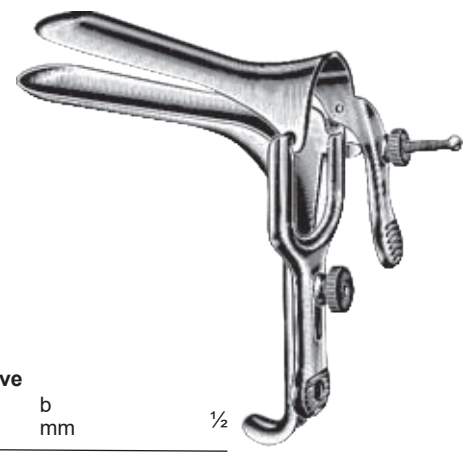

**Grave**

a mm	b mm	
75	20	BS09-021-01
95	35	BS09-021-02
115	35	BS09-021-03

- BS09-013-01 - BS09-013-03 - detachable
- BS09-015-01 - detachable, top blade shorter
- BS09-017-01 - BS09-017-03 - detachable, with folding handles
- BS09-019-00 - Vaginal Speculum, for examination and operative work, self-retaining, with adjustable frame, Loktite ratchet, 2 mobile lateral valves, and 3 interchangeable blades fig. 1-3
- BS09-021-01 - BS09-021-03 - with lateral ratchet, detachable, lower blade convertible into vaginal retractor

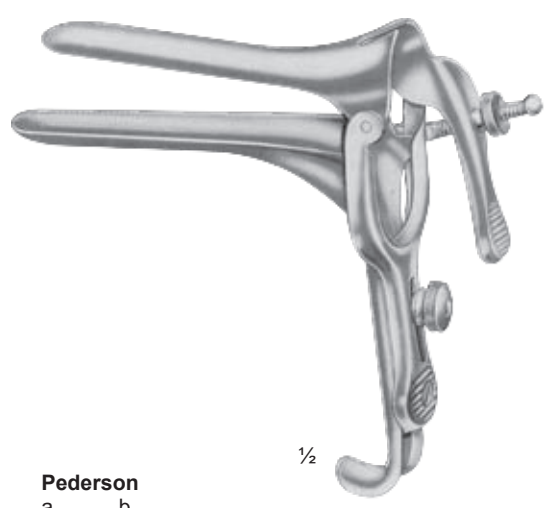

**Pederson**

a mm	b mm	
75	13	BS09-023-01
100	22	BS09-023-02
120	25	BS09-023-03



**Semm**

BS09-025-01	= 100 x 17/20 mm
BS09-025-02	= 100 x 25/30 mm



**Guttmann**

a mm	b mm	
90	35	BS09-027-01



**Guttmann**

a mm	b mm	
80	45	BS09-029-01

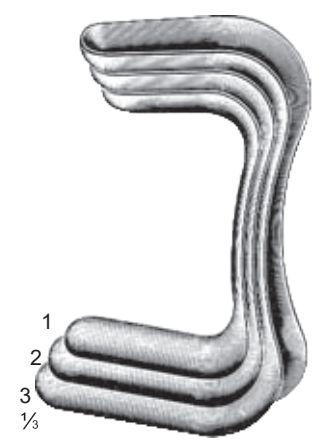

**Sims**

Fig	a mm	b mm	
1	60	25+30	BS09-031-01
2	70	30+35	BS09-031-02
3	80	35+40	BS09-031-03

BS09-025-01 - BS09-025-02 - for one handed use  
 BS09-027-01 - ditto, examining pattern, self-retaining  
 BS09-029-01 - ditto, operating pattern, self-retaining  
 BS09-031-01 - BS09-031-03 - double, medium-concave

Vaginal Specula

Scheme of dimensions for specula

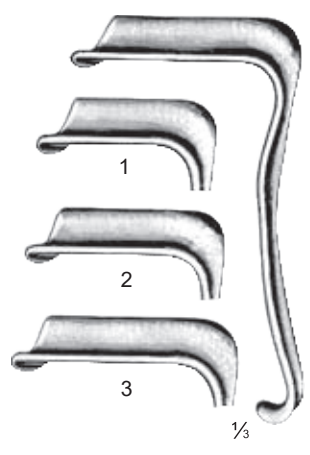
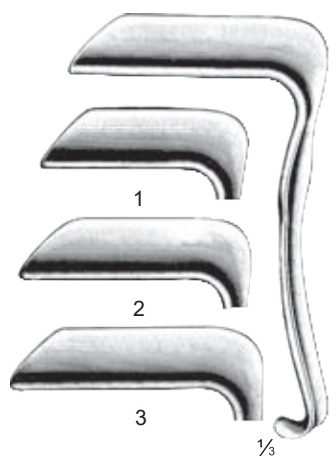
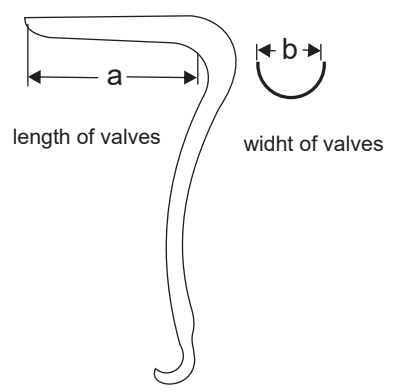

Jackson			Eastman			Auvard		
b = 35 mm	b = 40 mm	Fig.	a mm	b = 35 mm	b = 40 mm	a mm	b mm	Set
BS09-033-01	BS09-035-01	1	75	BS09-037-01	BS09-039-01	75	40	BS09-041-00
BS09-033-02	BS09-035-02	2	90	BS09-037-02	BS09-039-02	90	45	
BS09-033-03	BS09-035-03	3	100	BS09-037-03	BS09-039-03			



**Kirsteller**

Fig.	a mm	b mm	Specula
1	70	27	BS09-043-01
2	75	30	BS09-043-02
3	90	36	BS09-043-03



**Kristeller**

Fig.	a mm	b mm	Retractors
1	75	23	BS09-045-01
2	80	26	BS09-045-02
3	95	32	BS09-045-03



**Kristeller**

Set of 1 Speculum and 1 Retractor each	
Fig.	Product
1	BS09-047-01
2	BS09-047-02
3	BS09-047-03





**Kirsteller**

Set of 1 Specula and 1 Retractor each

Fig. 00	BS09-049-01
0	BS09-049-02



**Kirsteller**

Fig.	a mm	b mm	Specula
00	110	18	BS09-051-01
0	110	21	BS09-051-02



**Kirsteller**

Fig.	a mm	b mm	Retractors
00	115	14	BS09-053-01
0	115	17	BS09-053-02

**Kirsteller**

Set of 1 Specula and 1 Retractor each

- Fig. 1      BS09-055-01
- Fig. 2      BS09-055-02
- Fig. 3      BS09-055-03

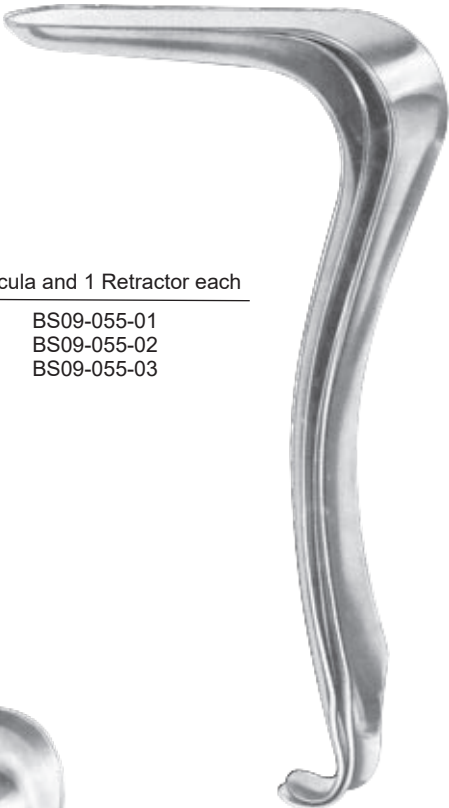

½

Fig.	a mm	b mm	Specula
1	110	27	BS09-057-01
2	110	30	BS09-057-02
3	110	36	BS09-057-03

**Kirsteller**

Fig.	a mm	b mm	Retractors
1	115	23	BS09-059-01
2	115	26	BS09-059-02
3	115	32	BS09-059-03

Specula deep hollow

**Kirsteller**

Set of 1 Speculum and 1 Retractor each

Fig. 1	BS09-061-01
2	BS09-061-02
3	BS09-061-03

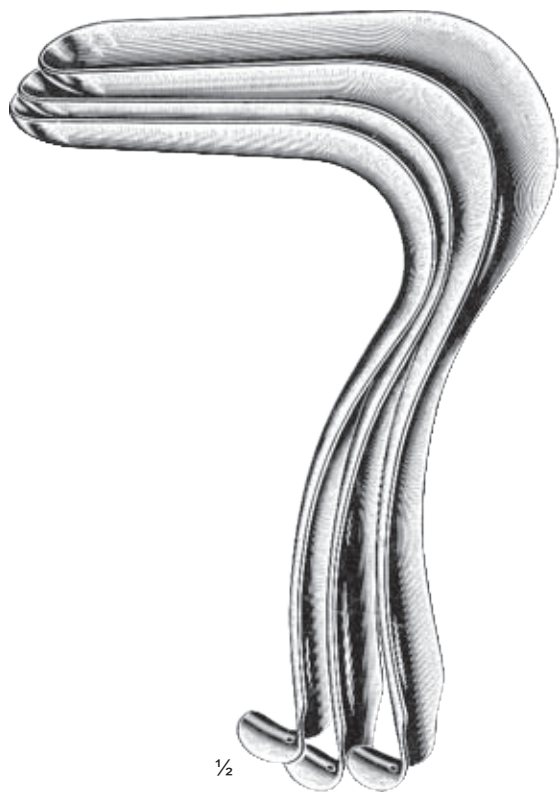
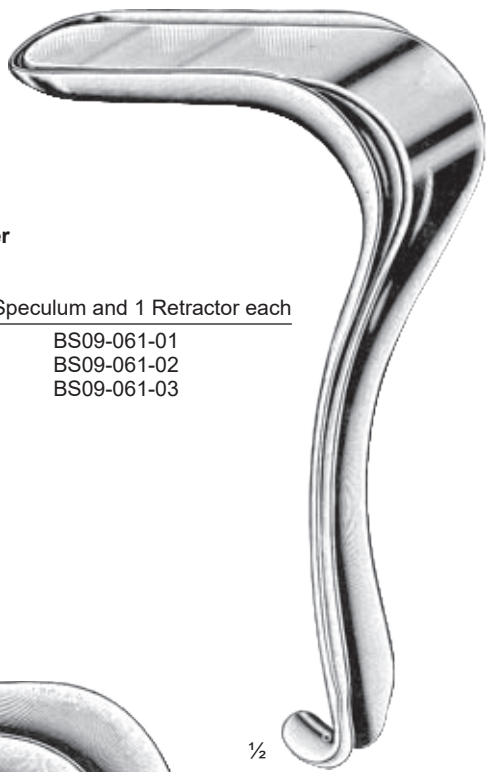

**Kirsteller**

Fig.	a mm	b mm	Specula
1	110	27	BS09-063-01
2	110	30	BS09-063-02
3	110	36	BS09-063-03

**Kirsteller**

Fig.	a mm	b mm	Retractors
1	115	23	BS09-065-01
2	115	26	BS09-065-02
3	115	32	BS09-065-03







**Kallmorgen**

vaginal Specula  
a b  
Fig. mm mm

1	70	40	BS09-067-01
2	90	40	BS09-067-02

vaginal Retractors  
a b  
Fig. mm mm

1	70	30	BS09-069-01	BS09-071-01
2	90	30	BS09-069-02	BS09-071-02



**Mathieu**

vaginal Specula  
a b  
mm mm

100	13/23	BS09-073-01
100	16/30	BS09-073-02

for virgins

vaginal Retractors  
a b  
Fig. mm mm

1*	100	11/21	BS09-075-01	BS09-077-01
2	100	14/27	BS09-075-02	BS09-077-02



**Barun**  
BS09-079-01  
18 cm / 7"



**Barun**  
BS09-081-01  
18 cm / 7"



**Ulrich**  
BS09-083-01  
19.5 cm / 7 1/2"



BS09-085-01  
19 cm / 7 1/2"

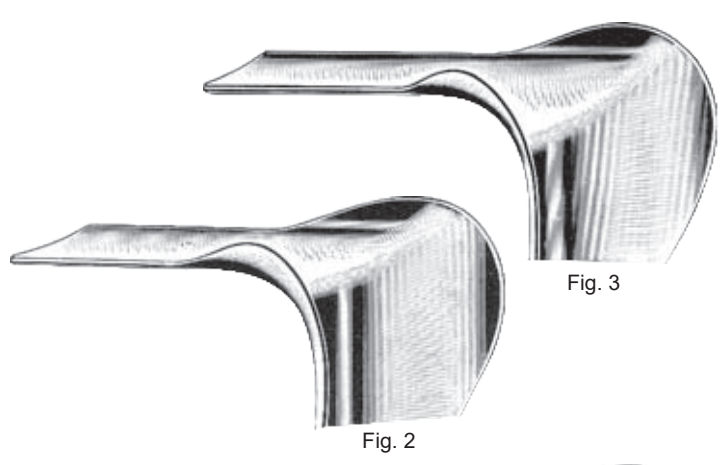
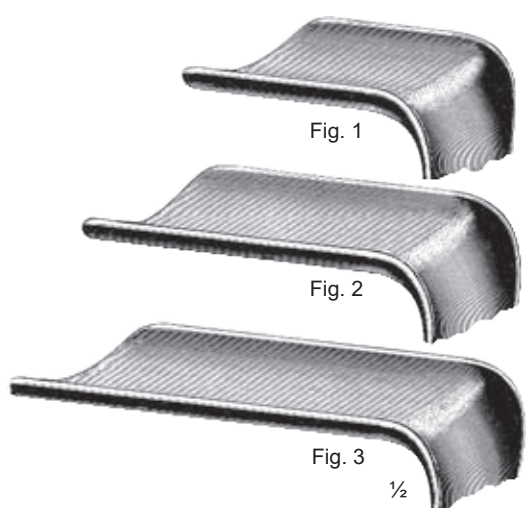

Fig.	a mm	b mm	slightly-concave	slightly-concave (MPF)	medium-concave
1	55	35	BS09-087-01		BS09-097-01
2	85	35	BS09-087-02		BS09-097-02
3	115	35	BS09-087-03		BS09-097-03
1	55	45	BS09-089-01	BS09-093-01	BS09-099-01
2	85	45	BS09-089-02	BS09-093-02	BS09-099-02
3	115	45	BS09-089-03	BS09-093-03	BS09-099-03
1	55	60	BS09-091-01	BS09-095-01	BS09-101-01
2	85	60	BS09-091-02	BS09-095-02	BS09-101-02
3	115	60	BS09-091-03	BS09-095-03	BS09-101-03

Fig.	a mm	b mm
BS09-103-01 = 1	55	45
BS09-103-02 = 2	85	45
BS09-103-03 = 3	115	45



**Doyen MPF**  
BS09-093-01 - BS09-095-03

**Doyen**  
BS09-087-01 - BS09-091-03  
BS09-097-01 - BS09-101-03

**Doyen**

Blades fitting on Scherbak and Bozemann Handles

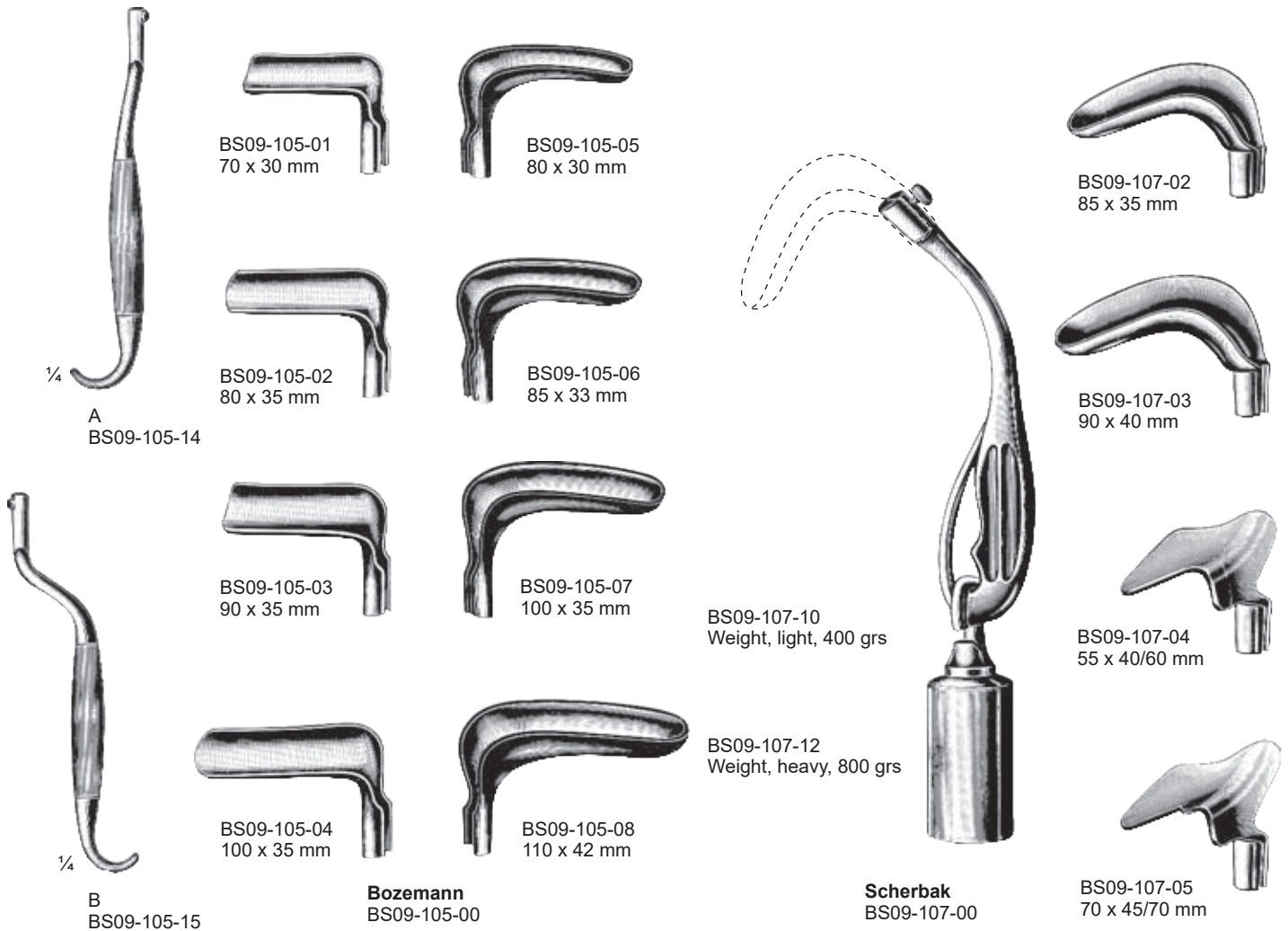

- BS09-105-00 - Set consisting of handle A and B and 8 blades
- BS09-105-01 - BS09-105-08 - Blades only
- BS09-105-14 - BS09-105-15 - Handles A and B only
- BS09-107-00 - Set consisting of handle, weight and 5 blades
- BS09-107-01 - BS09-107-05 - Blades only
- BS09-107-10 - Weight, only, light, 400 grs.
- BS09-107-12 - ditto, heavy, 800 grs.
- BS09-107-14 - Handle only



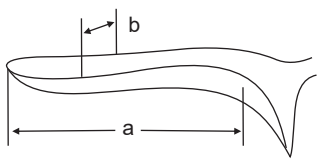

Other patterns on request

with detachable weight of 2.3 lbs



**Auvard**  
a b  
mm mm  
75 40  
BS09-109-11

with fixed weight



**Auvard**  
a b  
mm mm kg lbs  
83 38 1.14 2.5  
BS09-111-11



**Weissbarth**  
21 cm 8 1/4"  
a b  
mm mm  
80 42  
BS09-113-21

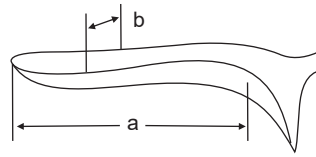

**Breisky**  
29cm/11½"



**Breisky**  
32cm/12½"



**Breisky**  
35cm/13¾"



**Breisky**  
37cm/14¼"

	a	b		a	b		a	b	
BS09-115-20	100 x 20mm		BS09-117-20	130 x 20mm		BS09-119-20	160 x 20mm	BS09-121-20	180 x 20mm
BS09-115-25	100 x 25mm		BS09-117-25	130 x 25mm		BS09-119-25	160 x 25mm	BS09-121-25	180 x 25mm
BS09-115-30	100 x 30mm		BS09-117-30	130 x 30mm		BS09-119-30	160 x 30mm	BS09-121-30	180 x 30mm
BS09-115-35	100 x 35mm		BS09-117-35	130 x 35mm		BS09-119-35	160 x 35mm	BS09-121-35	180 x 35mm
BS09-115-40	100 x 40mm		BS09-117-40	130 x 40mm		BS09-119-40	160 x 40mm	BS09-121-40	180 x 40mm





½

**Landau**  
BS09-123-01 - BS09-123-02

a mm	b mm	
100	28	BS09-123-01
100	38	BS09-123-02



95 x 45 mm

½

**Dunkel**  
BS09-125-22



95 x 17 - 30mm

½

**Mathieu**  
BS09-127-21  
21cm/8¼"

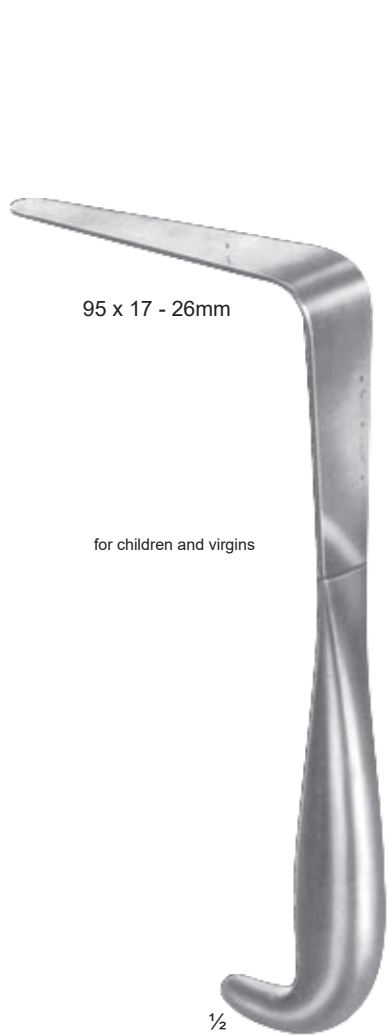

**Mathieu**  
BS09-129-21  
21cm/8 1/4"



**Doyen**  
BS09-131-24  
24 cm /9 3/4"

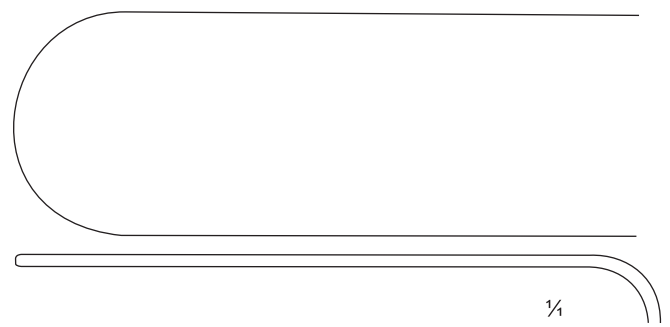

**Olshausen**  
BS09-133-21  
21 cm/8 1/4"



1/2

**Friedman**  
BS09-135-10  
10 cm /4"

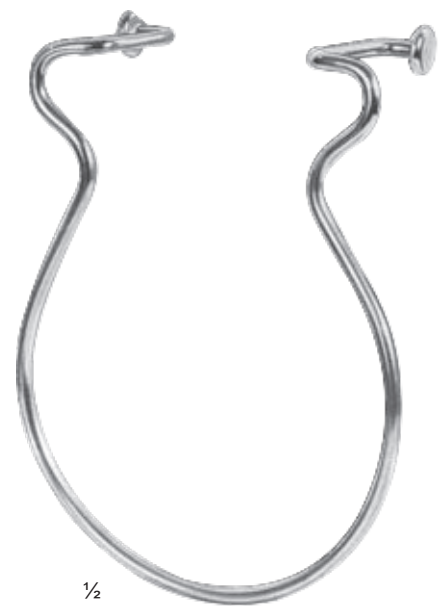

1/2

**Stieglitz**  
BS09-137-12 = 12 x 12 cm /4 3/4 x 4 3/4"  
BS09-137-14 = 14 x 14 cm /5 1/2 x 5 1/2"

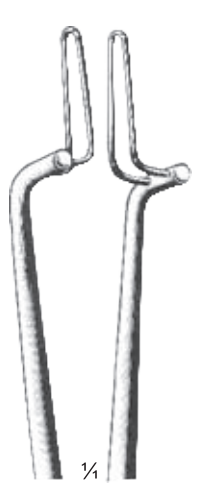

1/4

1/2

**Kogan**  
BS09-139-24  
24 cm /9 1/2"

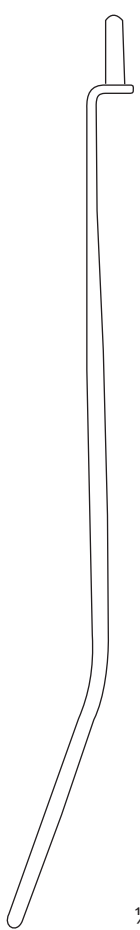

1/2

**Kogan**  
BS09-141-24  
24 cm /9 1/2"



Tenaculum Forceps  
Also Towel Forceps

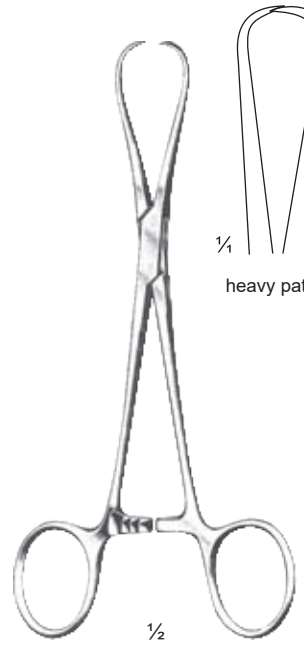

1/4

heavy pattern

1/2

**Staudemoore (Bernhard)**  
BS09-143-17  
17cm/6 3/4"

- BS09-135-10
- BS09-137-12 - BS09-137-14
- BS09-139-24
- BS09-141-24

- Retractor, self-retaining, for perineorrhaphy
- Vulva Retractors
- Endospecula for cervix and urethra, with S-shaped curve and fenestrated jaws
- without ratchet
- with scale-ratchet and fixing screws





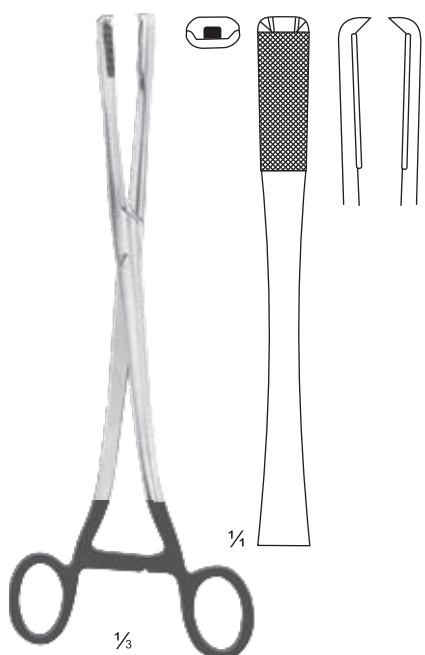

**H. G. Muller**  
BS09-145-24  
24 cm / 9 1/2"

with guide blades

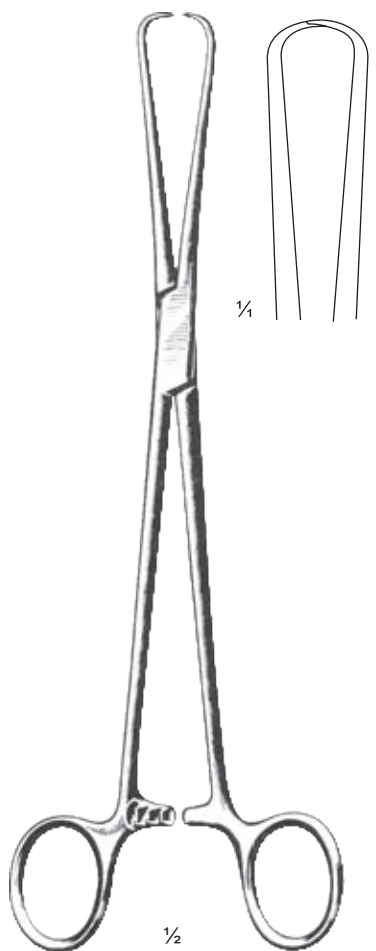
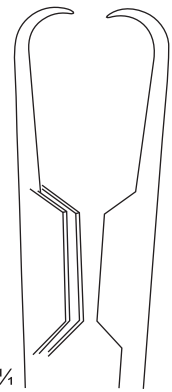

**Schroeder**  
BS09-147-25  
25cm/10"

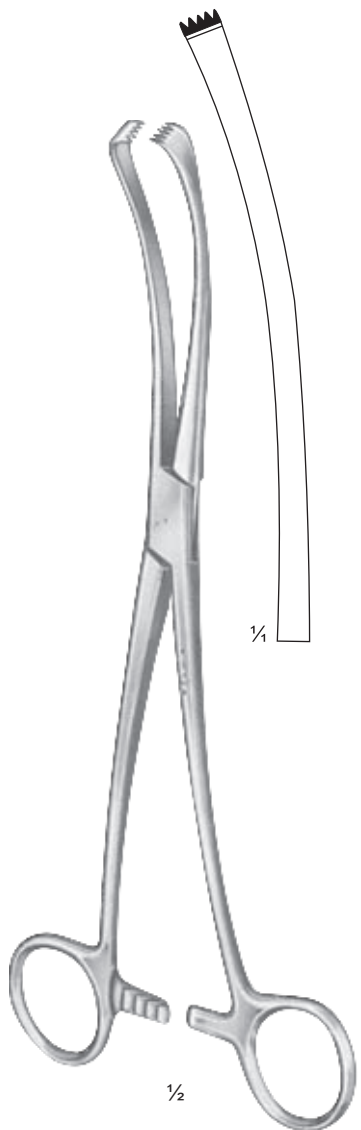

**Iowa**  
BS09-149-26  
26cm/10 1/4"



**Duplay**  
BS09-151-28  
28cm/11"

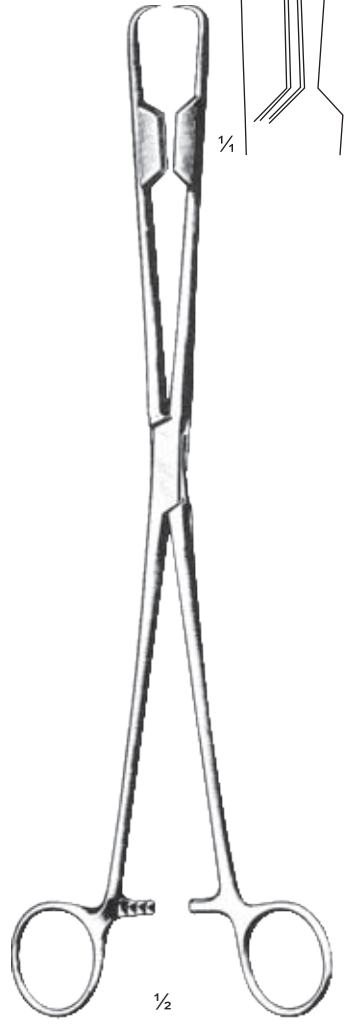

**Abel**  
BS09-153-27  
27cm/10 1/2"



Tenaculum Forceps

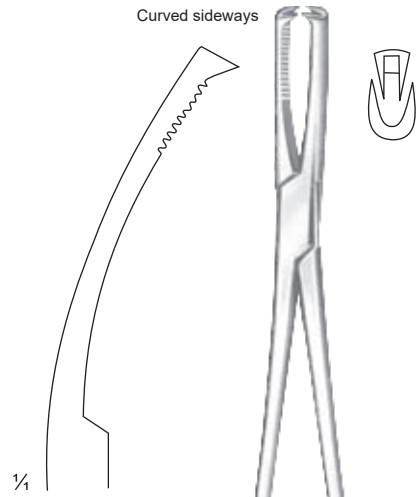

**Jacobs**  
BS09-155-21  
21cm/8¼"  
Straight

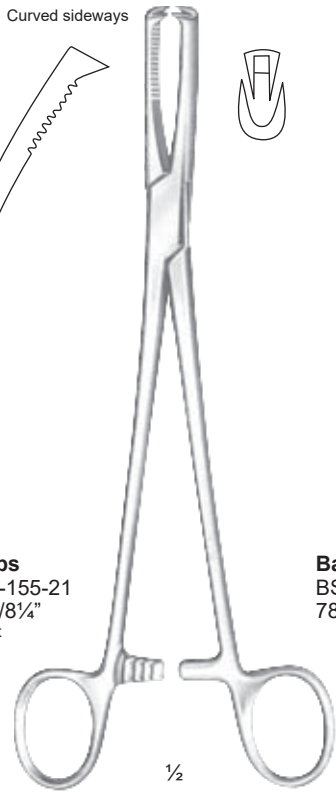

**Barrett**  
BS09-157-18  
78cm/7"

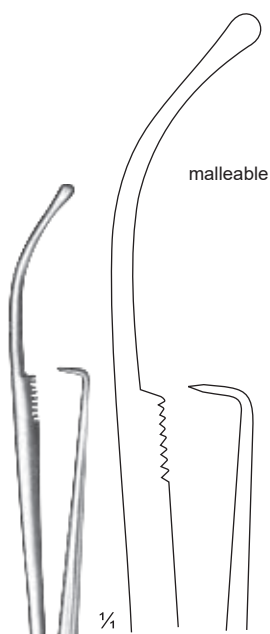
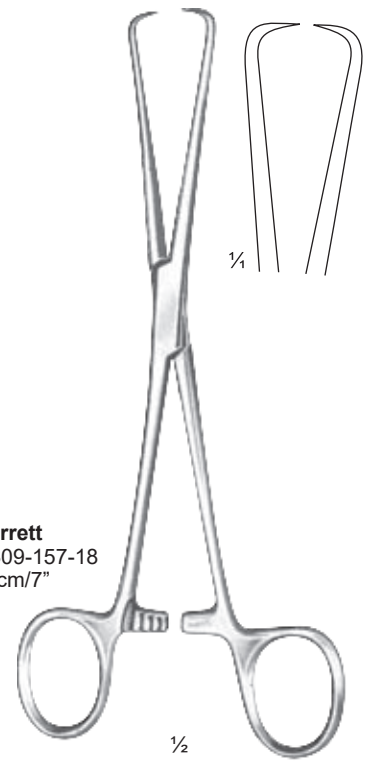

**Hulka**  
BS09-159-30  
30cm/12"

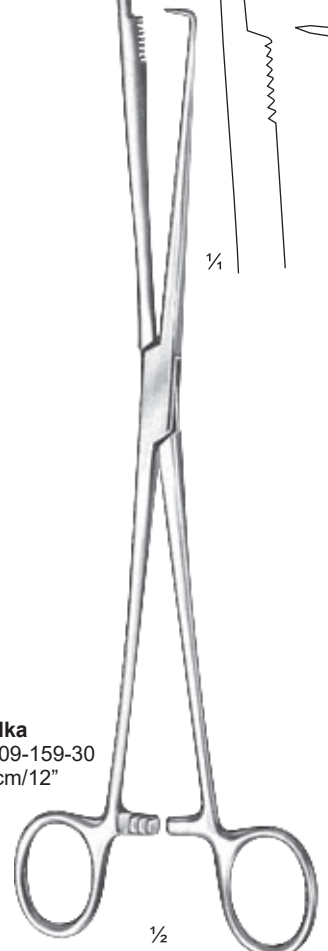

**Pozzi**  
BS09-161-25  
5.5cm/10¼"



**Collin-Pozzi**  
BS09-163-25  
25cm/10"



**Skene**  
BS09-165-24  
24cm/9½"

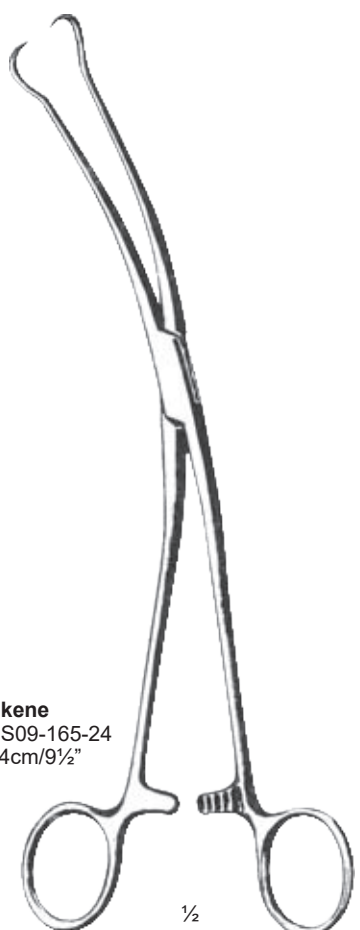

Tenaculum Forceps

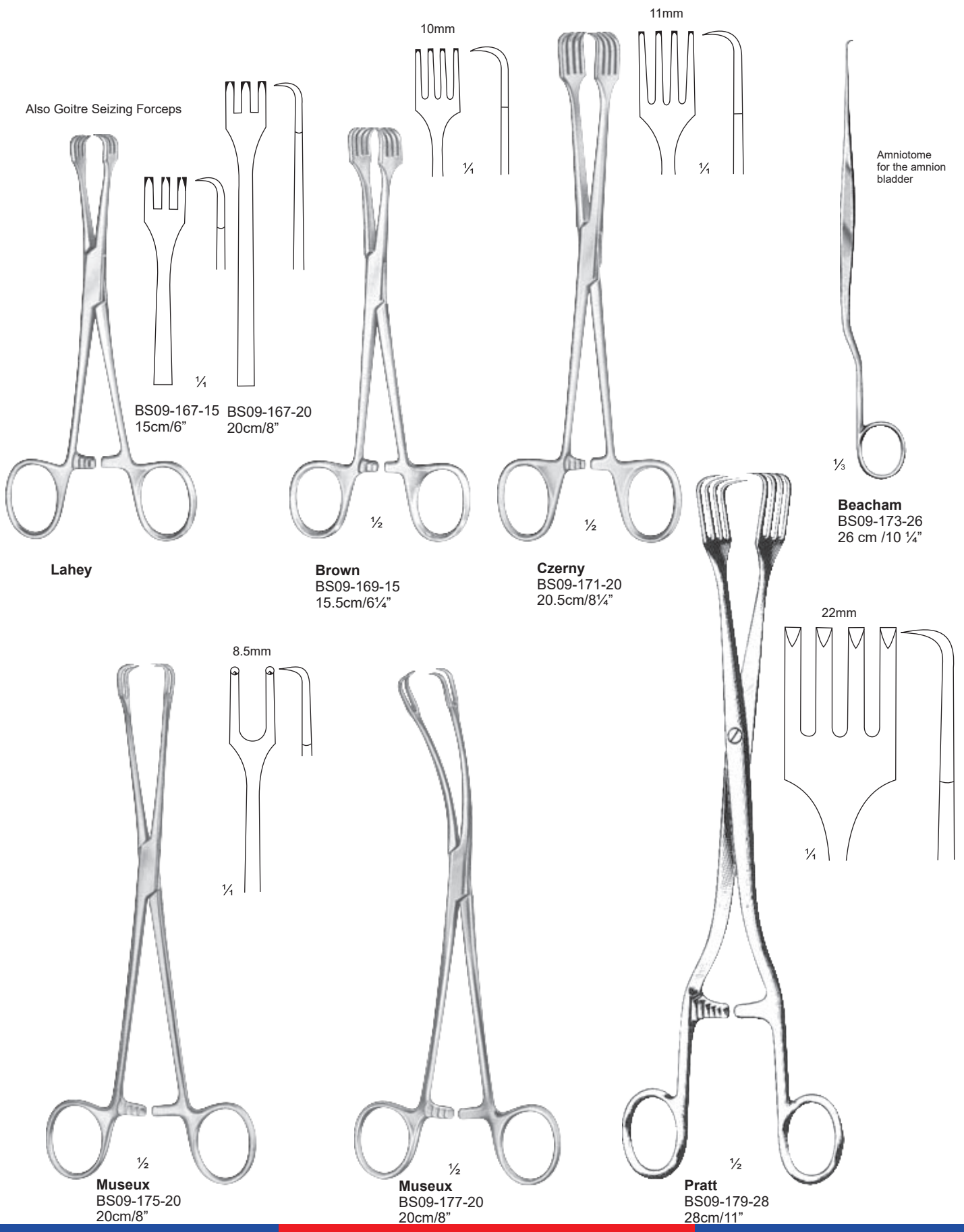

**Lahey**

**Brown**  
BS09-169-15  
15.5cm/6 1/4"

**Czerny**  
BS09-171-20  
20.5cm/8 1/4"

**Beacham**  
BS09-173-26  
26 cm /10 1/4"

**Museux**  
BS09-175-20  
20cm/8"

**Museux**  
BS09-177-20  
20cm/8"

**Pratt**  
BS09-179-28  
28cm/11"

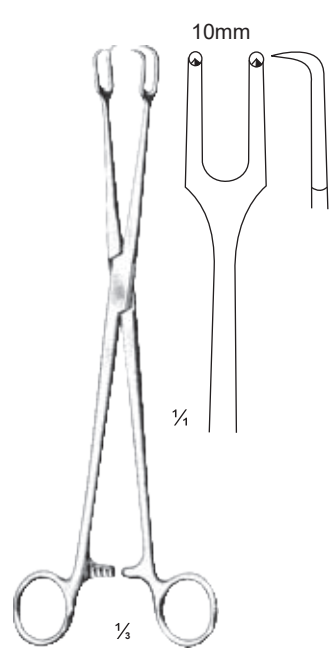

**Schroeder**  
BS09-181-24  
24cm/9½"

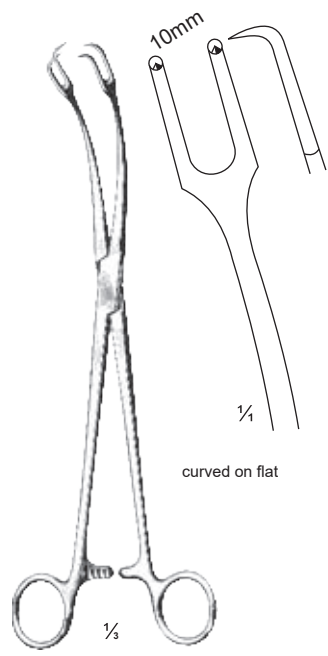

**Schroeder**  
BS09-183-24  
24cm/9½"

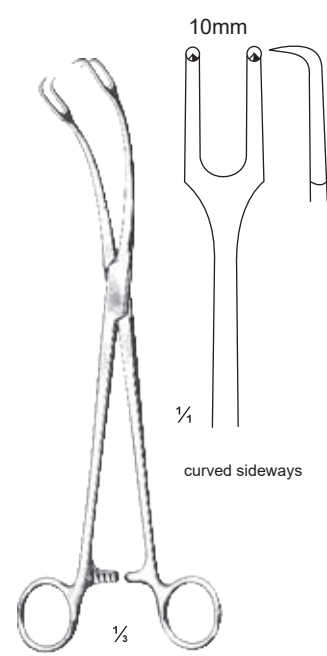

**Schroeder**  
BS09-185-24  
24cm/9½"



**Teale**  
BS09-187-23  
23cm/9"



**Museux**  
BS09-189-06= 6mm  
BS09-189-08= 8mm  
BS09-189-10= 10mm  
24cm/9½"

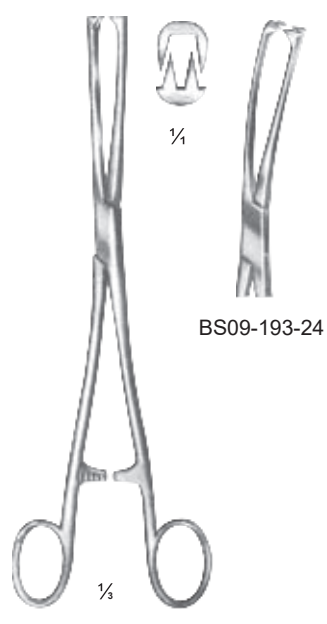

**Museux**  
BS09-191-24  
24cm/9½"

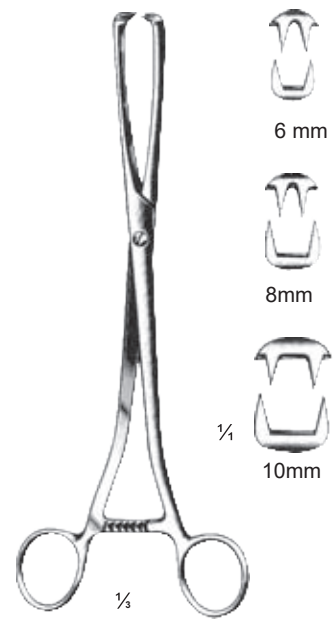

**Museux**  
BS09-195-06= 6mm  
BS09-195-08= 8mm  
BS09-195-10= 10mm  
24cm/9½"



**Henrotin**  
BS09-197-20  
20.5 cm /8"

Uterine Polypus Forceps, Uterine Elevating Forceps



**Collin**  
BS09-201-25  
25cm/10"

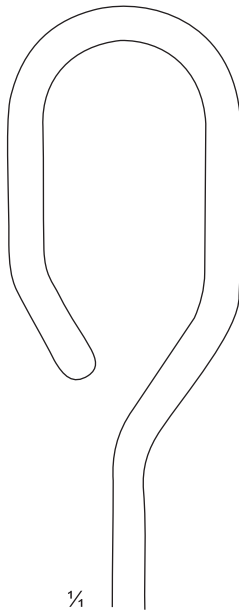

Also Kidney  
Seizing Forceps

**Dartigues**  
BS09-203-27  
27cm/10½"

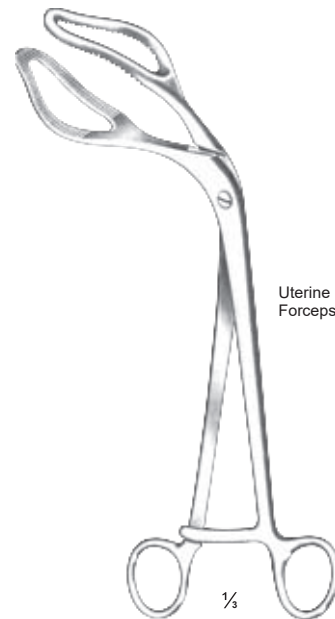
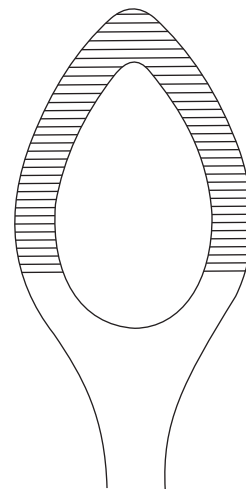

Uterine Elevating  
Forceps

**Sommer**  
BS09-205-23  
23cm/9"



**Doyen**  
BS09-207-20  
20 cm / 8"



**Pruesmann**  
BS09-209-27  
27.5 cm / 10 3/4"

Uterine Polypus Forceps,  
Ovarian Forceps



**Heywood-Smith**  
BS09-211-25  
25cm/10"

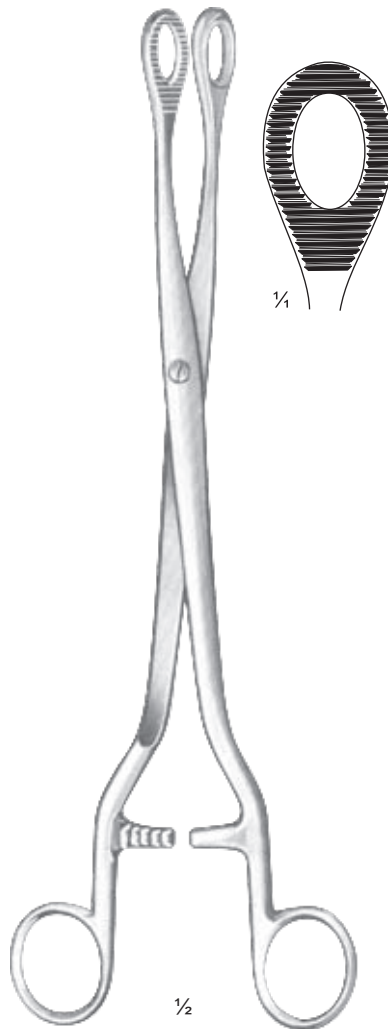

**Noto**  
BS09-213-27  
27cm/10 1/2"

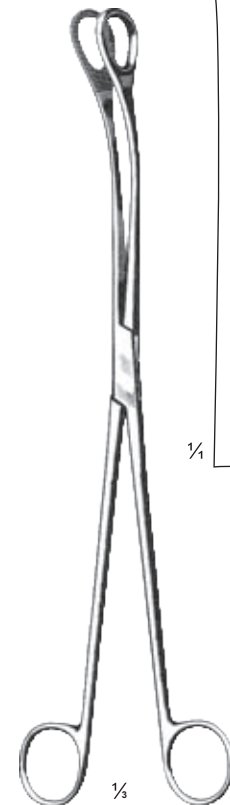

**Kelly**  
BS09-215-32  
32cm/12 1/2"



**Wylie**  
BS09-221-29  
29 cm / 11 1/2"  
with smooth jaws



**BS09-223-29**  
with serrated jaws

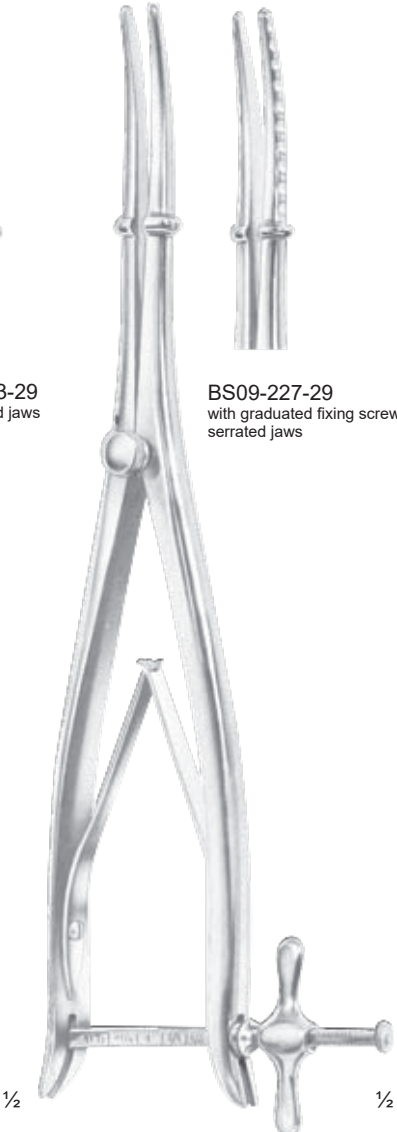

**Wylie**  
BS09-225-29  
29 cm / 11 1/2"  
with graduated fixing screw,  
smooth jaws



**BS09-227-29**  
with graduated fixing screw,  
serrated jaws



**Sims**  
BS09-229-29  
29 cm / 11 1/2"  
with fixing screw, three-bladed,  
smooth jaws



**Goodell**  
BS09-231-34  
34 cm / 13 1/2"  
with graduated fixing screw,  
serrated jaws

## Uterine Dilators



pieces per set	Set	Set	Set
14	4.0-17.0	BS09-233-80	BS09-237-80    BS09-239-80
23	4.0-26.0		
26	1.0-26.0	BS09-233-90	BS09-237-90    BS09-239-85

mm ø	with sloped handle	with serrated handle	with tube
1.0	BS09-233-01		BS09-237-01
1.5		BS09-235-01	
2.0	BS09-233-02		BS09-237-02
2.5		BS09-235-02	
3.0	BS09-233-03		BS09-237-03
3.5		BS09-235-03	
4.0	BS09-233-04		BS09-237-04    BS09-239-04
4.5		BS09-235-04	
5.0	BS09-233-05		BS09-237-05    BS09-239-05
5.5		BS09-235-05	
6.0	BS09-233-06		BS09-237-06    BS09-239-06
6.5		BS09-235-06	
7.0	BS09-233-07		BS09-237-07    BS09-239-07
7.5		BS09-235-07	
8.0	BS09-233-08		BS09-237-08    BS09-239-08
8.5		BS09-235-08	
9.0	BS09-233-09		BS09-237-09    BS09-239-09
9.5		BS09-235-09	
10.0	BS09-233-10		BS09-237-10    BS09-239-10
10.5		BS09-235-10	
11.0	BS09-233-11		BS09-237-11    BS09-239-11
11.5		BS09-235-11	
12.0	BS09-233-12		BS09-237-12    BS09-239-12
12.5		BS09-235-12	
13.0	BS09-233-13		BS09-237-13    BS09-239-13
13.5		BS09-235-13	
14.0	BS09-233-14		BS09-237-14    BS09-239-14
14.5		BS09-235-14	
15.0	BS09-233-15		BS09-237-15    BS09-239-15
15.5		BS09-235-15	
16.0	BS09-233-16		BS09-237-16    BS09-239-16
16.5		BS09-235-16	
17.0	BS09-233-17		BS09-237-17    BS09-239-17
17.5		BS09-235-17	
18.0	BS09-233-18		BS09-237-18    BS09-239-18
18.5		BS09-235-18	
19.0	BS09-233-19		BS09-237-19    BS09-239-19
19.5		BS09-235-19	
20.0	BS09-233-20		BS09-237-20    BS09-239-20
21.0	BS09-233-21		BS09-237-21    BS09-239-21
22.0	BS09-233-22		BS09-237-22    BS09-239-22
23.0	BS09-233-23		BS09-237-23    BS09-239-23
24.0	BS09-233-24		BS09-237-24    BS09-239-24
25.0	BS09-233-25		BS09-237-25    BS09-239-25
26.0	BS09-233-26		BS09-237-26    BS09-239-26
27.0	BS09-233-27		
28.0	BS09-233-28		
29.0	BS09-233-29		
30.0	BS09-233-30		



BS09-233-82  
Set of 14 dilators BS09-233-04 - BS09-233-17  
(4.0-17.0 mm ø), in pouch





mm $\varnothing$		
1.0/ 2.0	3.0/ 4.0	BS09-241-02
3.0/ 4.0	5.0/ 6.0	BS09-241-04
5.0/ 6.0		BS09-241-06
7.0/ 8.0		BS09-241-08
9.0/ 10.0		BS09-241-10
11.0/ 12.0		BS09-241-12
13.0/14.0		BS09-241-14
15.0/16.0		BS09-241-16
17.0/18.0		BS09-241-18
19.0/20.0		BS09-241-20
21.0/22.0		BS09-241-22
23.0/24.0		BS09-241-24
25.0/26.0		BS09-241-26



BS09-241-80  
Set of 8 dilators 3.0/4.0-17.0/18.0 mm  $\varnothing$

BS09-241-90  
Set of 13 dilators 1.0/2.0-25.0/26.0 mm  $\varnothing$

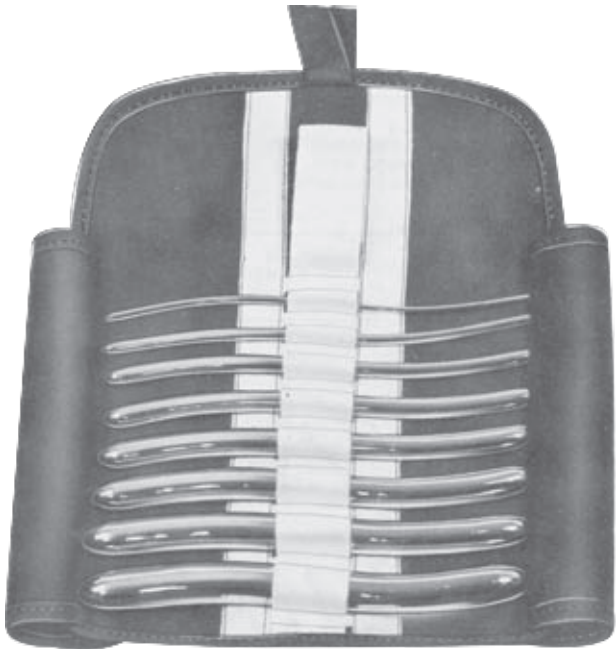

BS09-241-82  
Set of 8 dilators 3.0/4.0-17.0/18.0 mm  $\varnothing$  in pouch

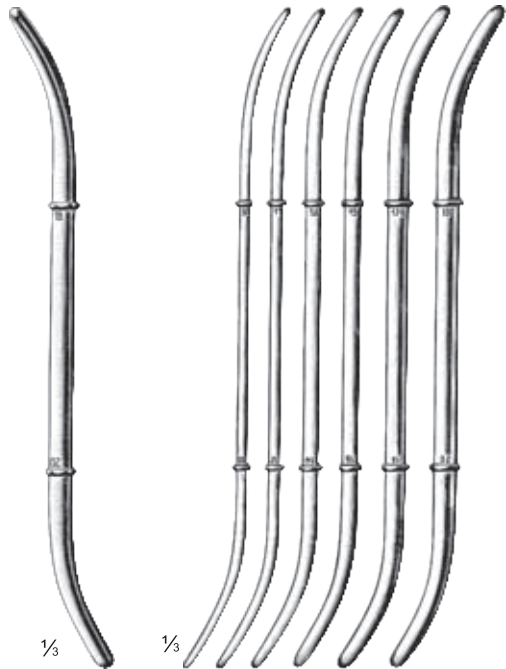

**Hank**  
BS09-243-10 -  
BS09-243-20

**Hank**  
BS09-243-80  
set

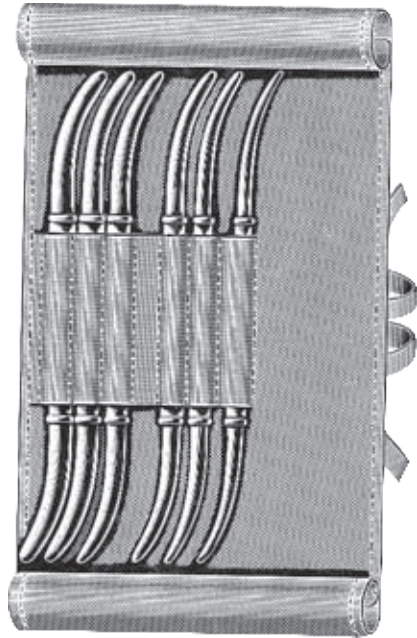

BS09-243-82  
set



**Landau**  
BS09-245-15  
BS09-245-80

**Jolly**  
BS09-247-05 -  
BS09-247-07

American scale		Hank
Fig.	mm ø	
9/10	4.5/5	BS09-243-10
11/12	5.5/6	BS09-243-12
13/14	6.5/7	BS09-243-14
15/16	7.5/8	BS09-243-16
17/18	8.5/9	BS09-243-18
19/20	9.5/10	BS09-243-20

- BS09-243-10 - BS09-243-20 - with conical point, double-ended, single
- BS09-245-15 - BS09-245-30 - Set of 6 pieces
- BS09-243-80, BS09-245-80 - ditto, in pouch
- BS09-243-82 - Conical shape, with bow fitting
- BS09-247-05 - Set of 5 pieces: 3-7, 5-7, 7-12, 9-15, and 12-18 mm ø
- BS09-247-07 - Set of 7 pieces: 3-7, 5-9, 7-12, 9-15, 12-18, 15-21 and 18-24 mm ø



**Sims**  
BS09-249-32  
BS09-251-32  
32 cm / 12 1/2"

**Martin**  
BS09-253-32  
BS09-255-32  
BS09-257-32  
BS09-259-32  
32 cm / 12 1/2"

**Collin**  
BS09-260-28  
28 cm / 11"

**Valleix**  
BS09-261-25  
25 cm / 10"

**Braun**  
BS09-263-26  
28 cm / 11"

**Sims**  
BS09-265-26  
26 cm / 10 1/4"

**Sims**  
BS09-267-27  
27 cm / 10 1/2"  
3.2 mm ø

- BS09-249-32 - Uterine Sound, graduated, with centimeter scale
- BS09-251-32 - ditto, malleable
- BS09-253-32 - Uterine Sounds, graduated
- BS09-255-32 - with centimeter scale
- BS09-257-32 - ditto, malleable
- BS09-259-32 - ditto, with slide
- BS09-261-25 - Uterine Depressor
- BS09-263-26 - ditto, toothed working ends
- BS09-265-26 - ditto, toothed working ends
- BS09-267-27 - BS09-269-27 - Uterine Sponge Holders, with fenestrated handle





**Doyen**  
BS09-271-17  
17 cm / 6 3/4"



**Doyen**  
BS09-273-17  
17 cm / 6 3/4"  
Myoma Screw (Tumor Screw)

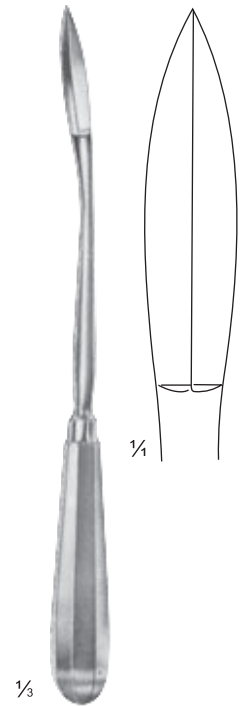

**Segond**  
BS09-275-27  
Myoma Knife

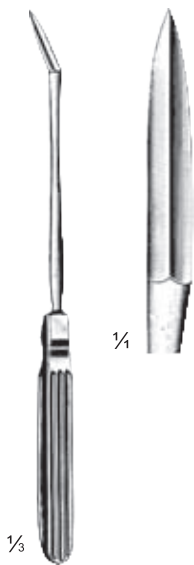

**Ayre**  
BS09-277-23  
23 cm / 9"

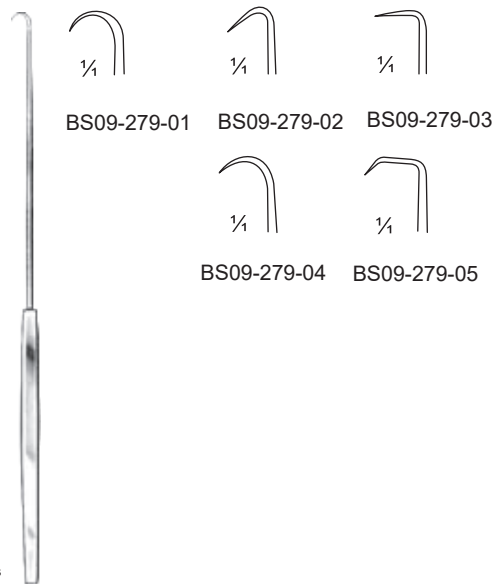

**Emmett**  
22 cm / 8 3/4"  
Fistula Hooks



**Simon**  
BS09-281-22  
22 cm / 8 3/4"  
Fistula Hooks



**Simon**  
BS09-283-22  
22 cm / 8 3/4"  
Fistula Hooks



**Randall**  
BS09-285-24  
24 cm / 9 1/2"  
4 mm ø  
Endometrial  
Suction Biopsy Curettes



**Novak**  
BS09-287-23  
23 cm / 9"  
4 mm ø  
Endometrial  
Suction Biopsy Curettes



**Kevorkiaan**  
BS09-289-30  
30 cm / 12"  
Biopsy Curette



**Mod. Muenchen**  
BS09-291-27  
27 cm / 10 1/2"  
Biopsy Curette



**Gellhorn**  
BS09-293-23  
23 cm / 9"



**Faure**  
BS09-295-21  
21 cm / 9 1/2"

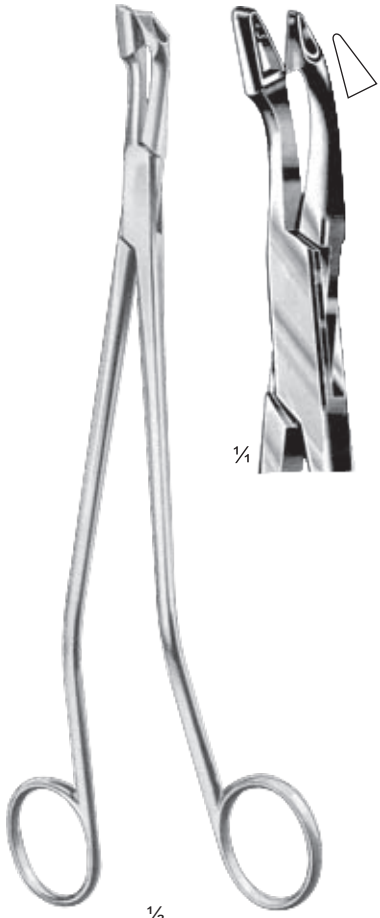

**Van Doren**  
BS09-297-24  
25 cm / 10"  
Its S-shaped construction allows clear view and sharply-delineated incisions.



**Thoms-Gaylor**  
BS09-299-22 = 22 cm / 8 1/2"  
BS09-299-24 = 24 cm / 9 1/2"

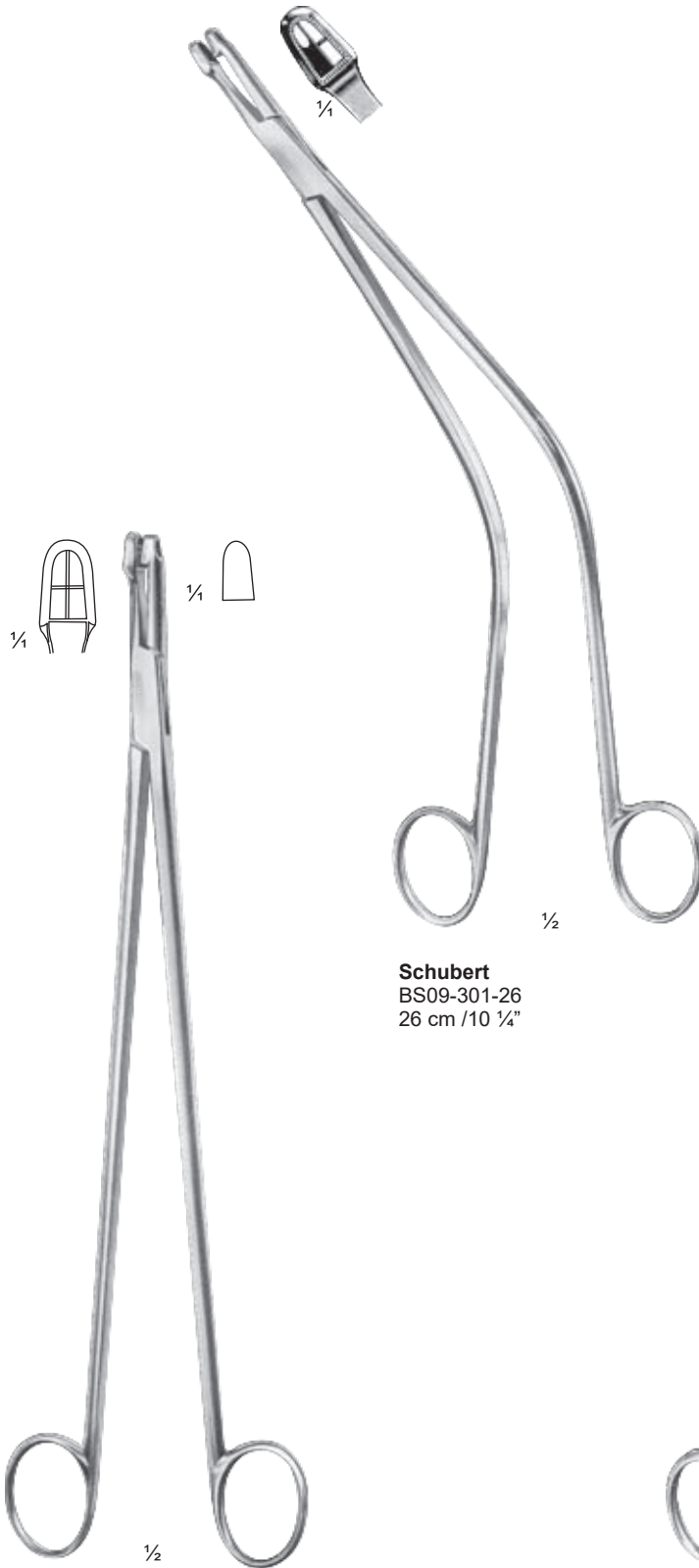

**Schubert**  
BS09-301-26  
26 cm / 10 1/4"

**Schubert**  
BS09-303-21 = 21 cm / 8 1/4"  
BS09-303-28 = 29 cm / 11 1/2"



**Thoms-Galar**  
BS09-305-24  
24 cm / 9 1/2"

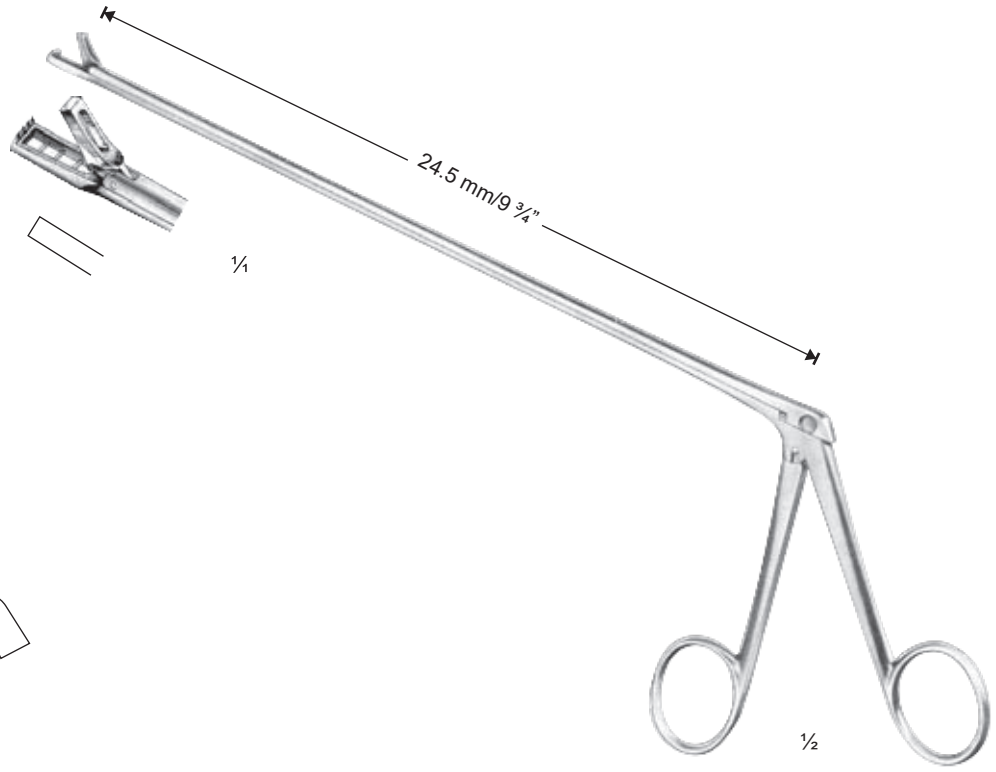

**Kevorkian**  
BS09-307-32



**Van Doren**  
BS09-309-25  
25 cm / 10"  
Its S-shaped construction allows clear view and sharply-delineated incisions.

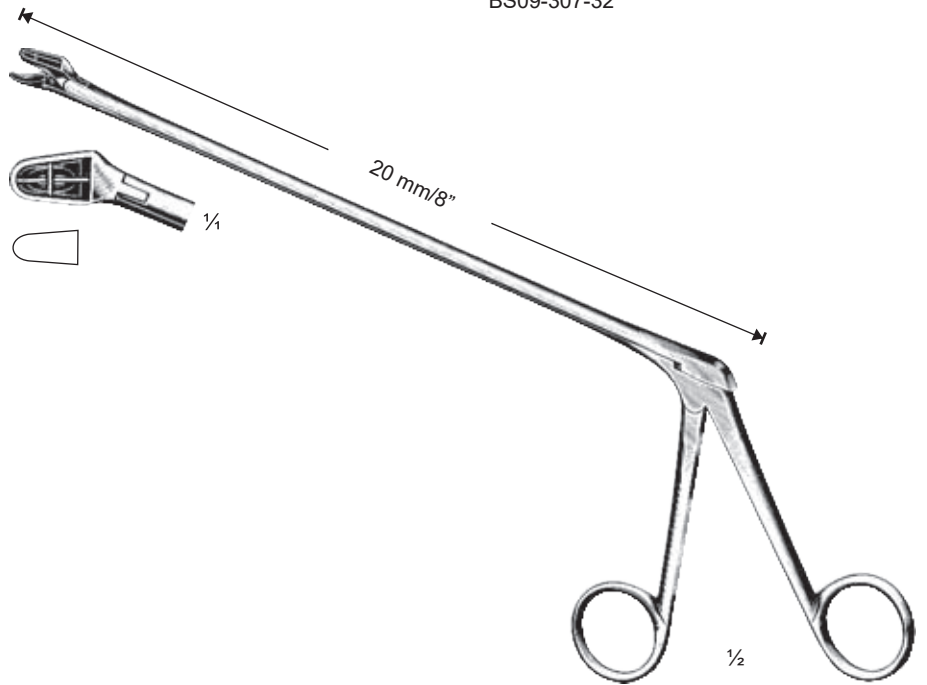

**Alexander**  
BS09-311-28  
28 cm / 11"  
Jaws cut with a pulling motion from point to rear. Cutting edge planted into tissue. Better view as jaws are curved to left.



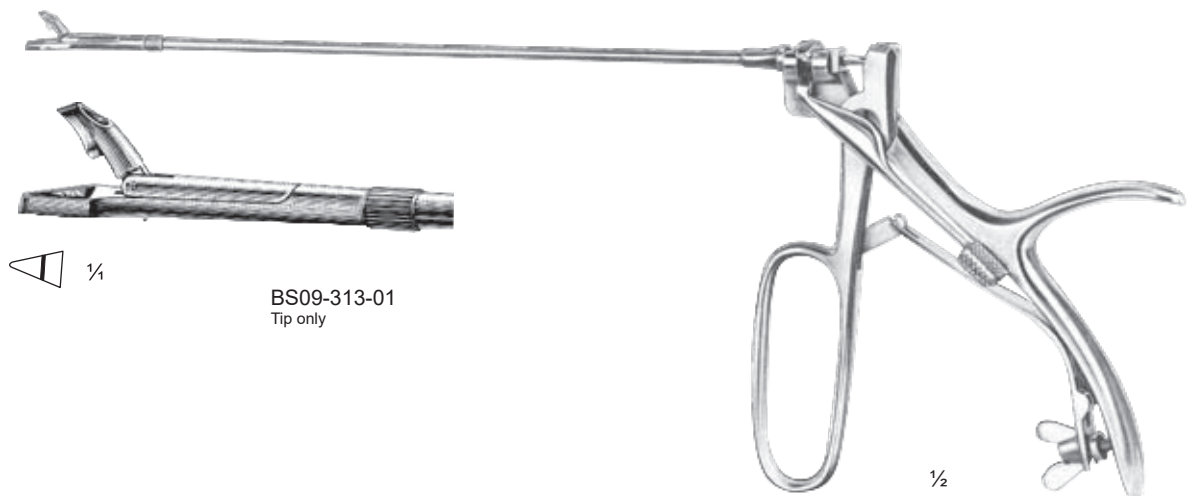

**BS09-313-01**  
Tip only

**Schumacher**  
**BS09-313-00**  
Schumacher Biopsy Specimen  
Forceps with exchangeable tip

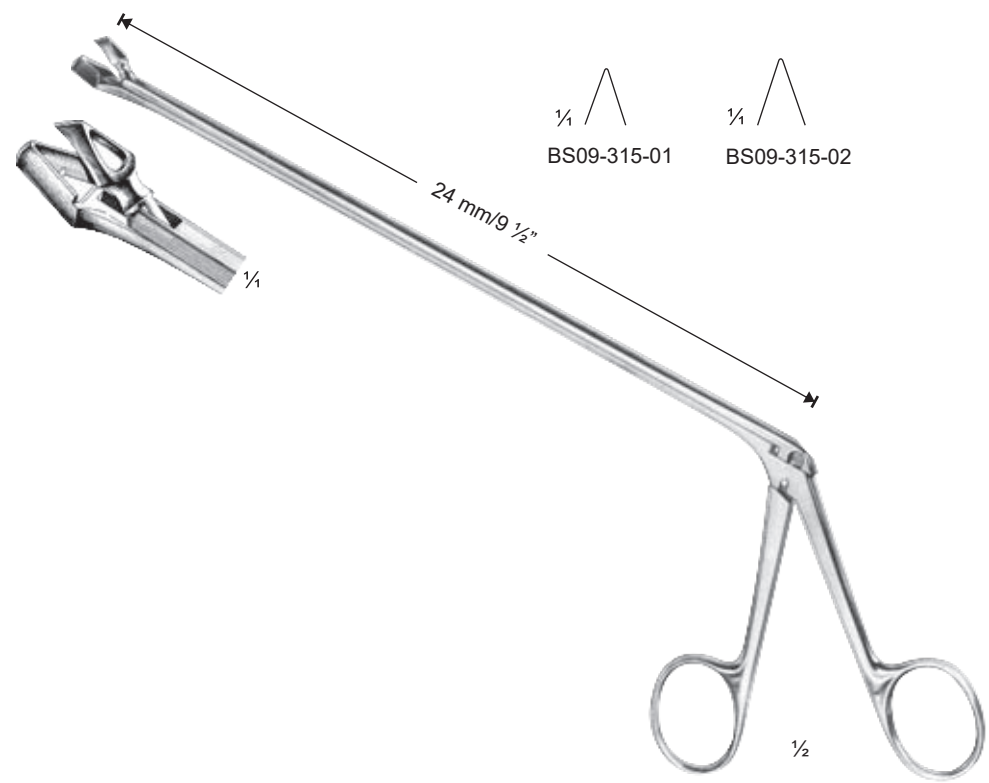

$\frac{1}{4}$   $\frac{1}{4}$   
**BS09-315-01**      **BS09-315-02**

24 mm / 9 1/2"

**Schumacher**  
**BS09-315-01 - 02**

Cervical Biopsy and Specimen Forceps

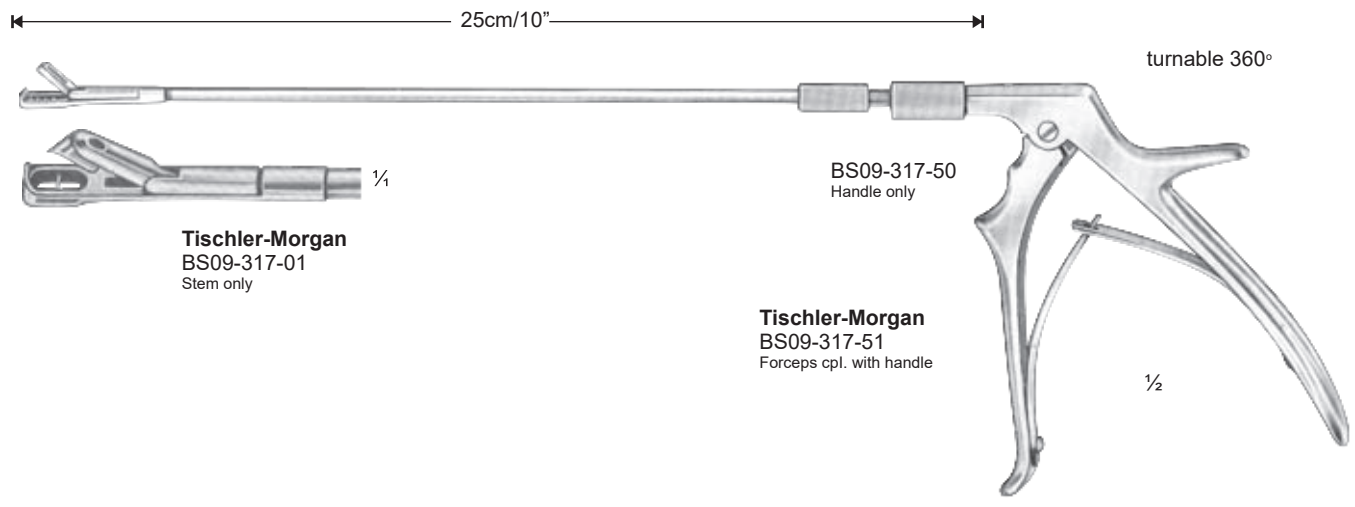

**Tischler-Morgan**  
BS09-317-01  
Stem only

BS09-317-50  
Handle only

**Tischler-Morgan**  
BS09-317-51  
Forceps cpl. with handle

turnable 360°

1/2

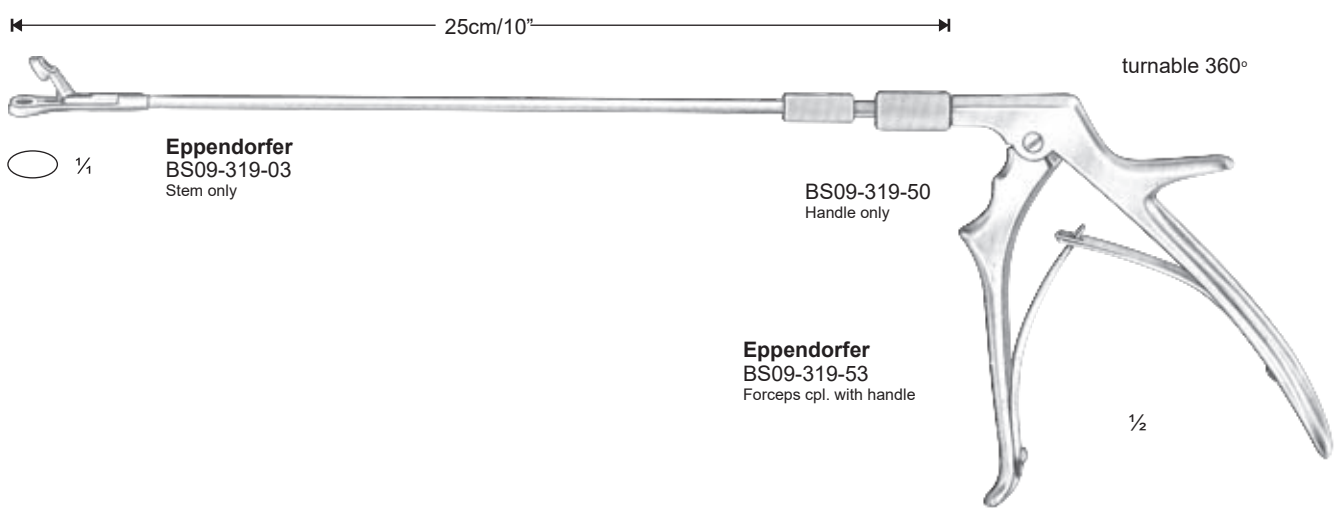

**Eppendorfer**  
BS09-319-03  
Stem only

BS09-319-50  
Handle only

**Eppendorfer**  
BS09-319-53  
Forceps cpl. with handle

turnable 360°

1/2

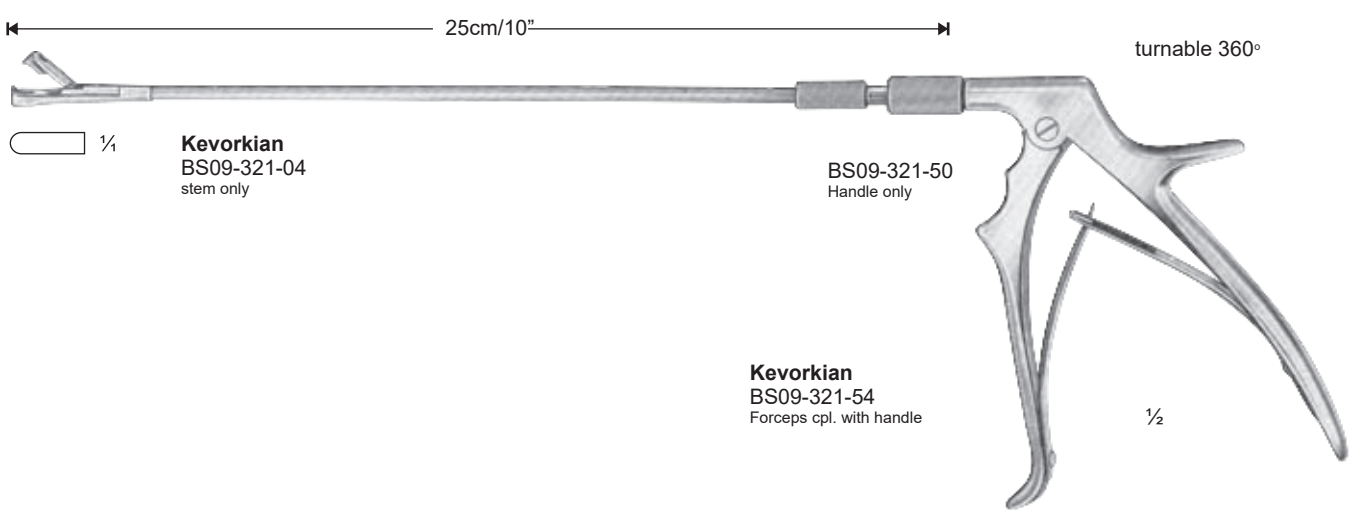

**Kevorkian**  
BS09-321-04  
stem only

BS09-321-50  
Handle only

**Kevorkian**  
BS09-321-54  
Forceps cpl. with handle

turnable 360°

1/2



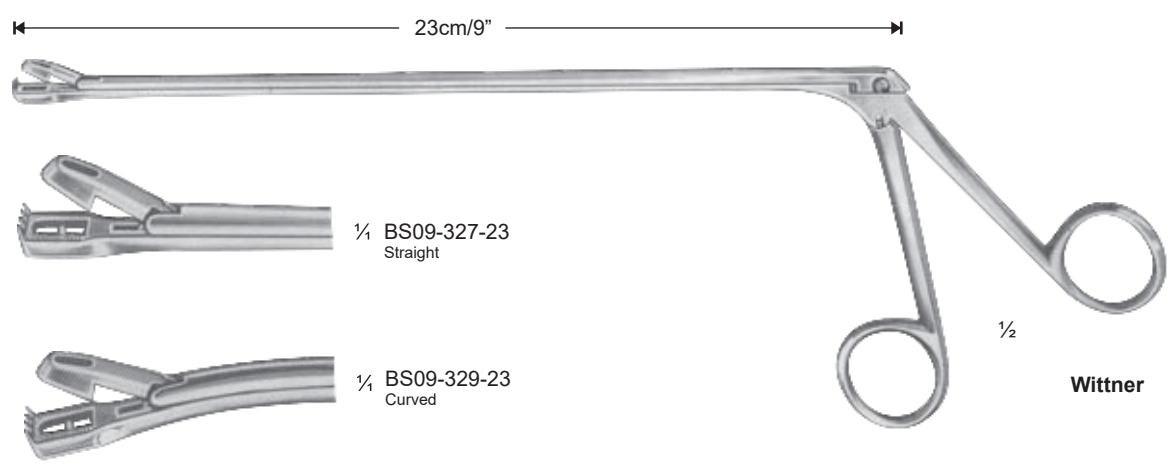
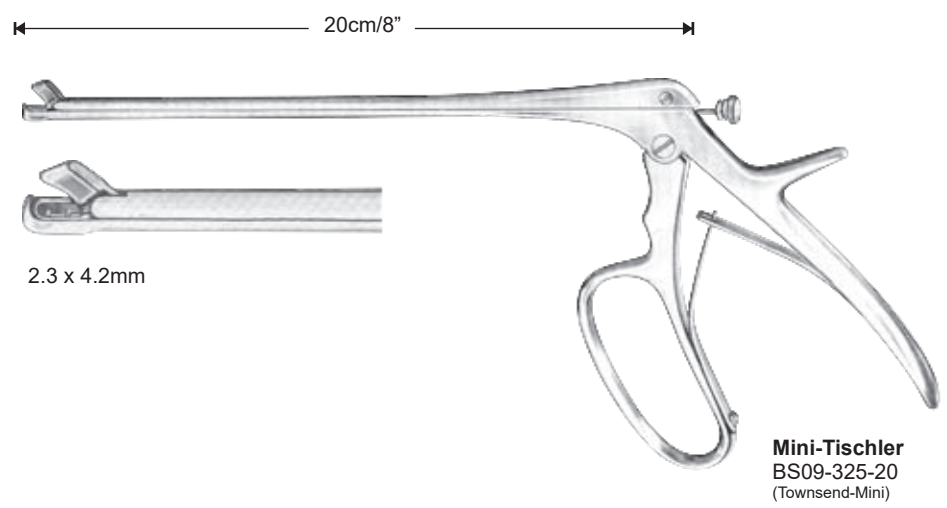
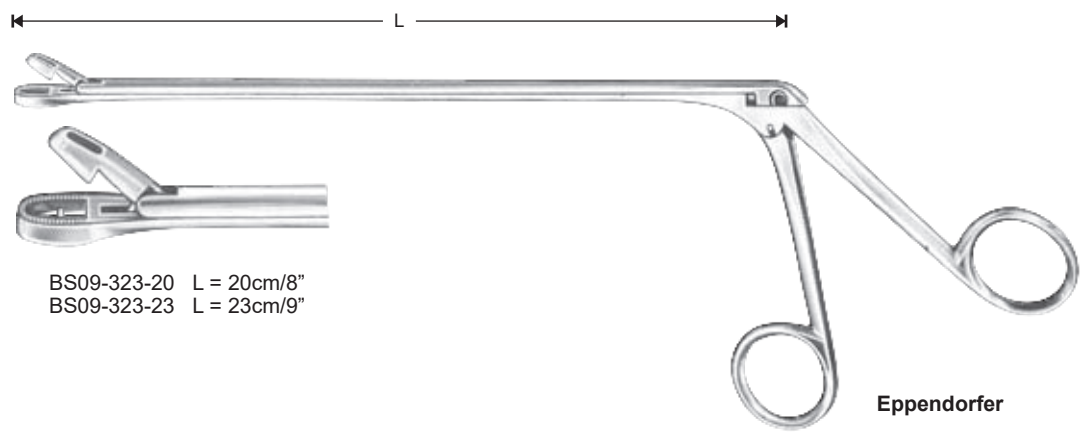

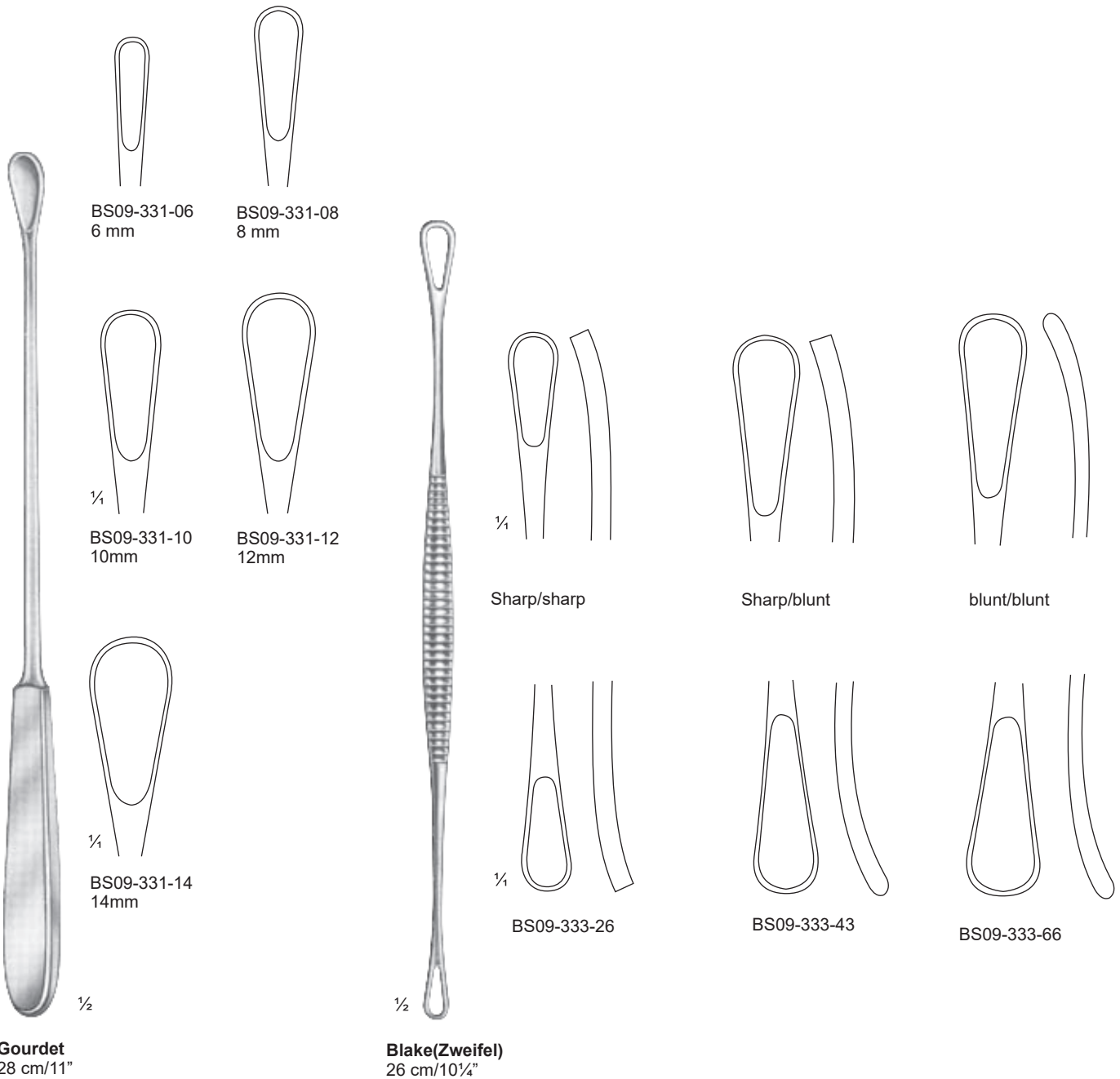

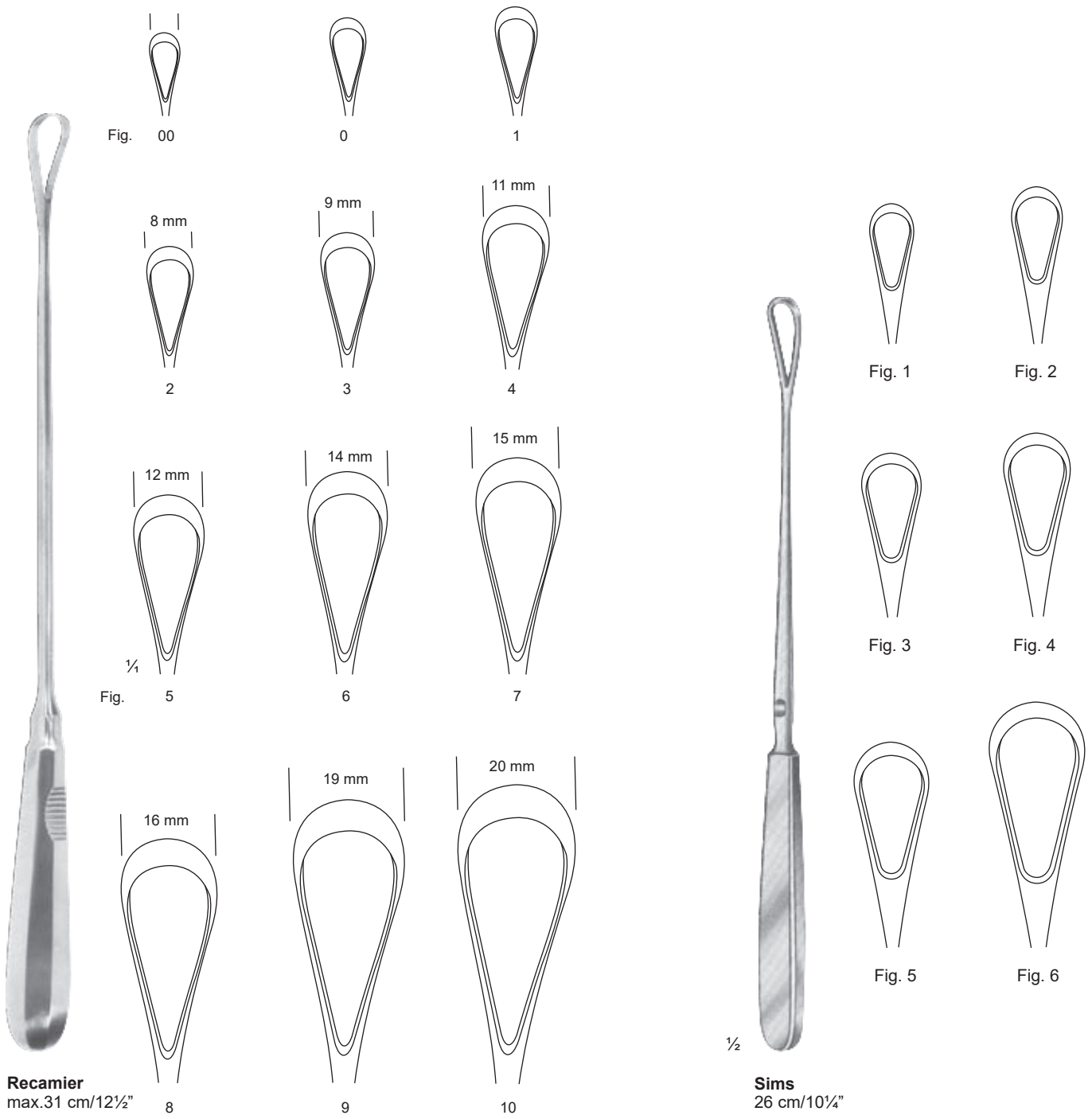

**Recamier**  
max.31 cm/12½"

**Sims**  
26 cm/10¼"

Sharp		blunt	
rigid	malleable	rigid	malleable
BS09-335-05	BS09-337-05	BS09-339-05	BS09-341-05
BS09-335-06	BS09-337-06	BS09-339-06	BS09-341-06
BS09-335-07	BS09-337-07	BS09-339-07	BS09-341-07
BS09-335-08	BS09-337-08	BS09-339-08	BS09-341-08
BS09-335-09	BS09-337-09	BS09-339-09	BS09-341-09
BS09-335-11	BS09-337-11	BS09-339-11	BS09-341-11
BS09-335-12	BS09-337-12	BS09-339-12	BS09-341-12
BS09-335-14	BS09-337-14	BS09-339-14	BS09-341-14
BS09-335-15	BS09-337-15	BS09-339-15	BS09-341-15
BS09-335-16	BS09-337-16	BS09-339-16	BS09-341-16
BS09-335-19	BS09-337-19	BS09-339-19	BS09-341-19
BS09-335-20	BS09-337-20	BS09-339-20	BS09-341-20

Sharp		blunt	
rigid	malleable	rigid	malleable
BS09-343-51	BS09-345-51	BS09-347-51	BS09-349-51
BS09-343-52	BS09-345-52	BS09-347-52	BS09-349-52
BS09-343-53	BS09-345-53	BS09-347-53	BS09-349-53
BS09-343-54	BS09-345-54	BS09-347-54	BS09-349-54
BS09-343-55	BS09-345-55	BS09-347-55	BS09-349-55
BS09-343-56	BS09-345-56	BS09-347-56	BS09-349-56



**Simon**  
25 cm/10"

Fig. sharp, rigid

1	BS09-351-01
2	BS09-351-02
3	BS09-351-03
4	BS09-351-04
5	BS09-351-05
6	BS09-351-06

**Schroeder**  
30 cm/12"

Fig. sharp, rigid

1	BS09-353-01
2	BS09-353-02
3	BS09-353-03
4	BS09-353-04
5	BS09-353-05
6	BS09-353-06

**Blake**  
BS09-355-27  
27 cm /10 1/2"  
sharp/blunt

**Bozemann-Fritsch**  
Uterine Douches

mm ø

8	BS09-357-08
10	BS09-357-10
12	BS09-357-12

**Hildebrandt**  
BS09-359-21  
21 cm /8 1/4"  
Vaginal Irrigating  
Cannula, of metal





BS09-361-03  
3 mm ø  
Aspirating Curettes

BS09-361-04  
4.5 mm ø  
Aspirating Curettes

BS09-361-06  
6 mm ø  
Aspirating Curettes

BS09-361-08  
8 mm ø  
Aspirating Curettes

BS09-361-10  
10 mm ø  
Aspirating Curettes

BS09-361-12  
12 mm ø  
Aspirating Curettes

BS09-361-14  
14 mm ø  
Aspirating Curettes

BS09-361-50  
Connecting Piece





$\frac{1}{4}$   
**Collin**  
BS09-363-35  
35 cm / 13  $\frac{3}{4}$ "  
cm scale



$\frac{1}{4}$   
**Breisky**  
BS09-365-33  
33 cm / 13"  
cm/inch scale



$\frac{1}{4}$   
**Martin**  
BS09-367-34 cm scale  
BS09-369-34 cm/inch scale  
34 cm / 13  $\frac{1}{2}$ "

for internal measurements



$\frac{1}{3}$   
**De Lee**  
BS09-371-20  
20 cm / 8"  
cm/inch scale



$\frac{1}{4}$   
**Collyer**  
BS09-373-30  
30 cm / 12"  
cm/inch scale





¼

**De Lee**  
BS09-375-36  
36 cm/14"



**Elliot**  
BS09-377-32 = 32 cm/12 ½"  
BS09-377-38 = 38 cm/15"



¼

**Mc Lean**  
BS09-379-36  
36 cm/14"



**Naegele**  
BS09-381-36 = 36 cm/14"  
BS09-381-40 = 40 cm/16"



¼

**Simpson**  
BS09-383-30  
30 cm/12"



¼

**Simpson-Braun**  
BS09-385-36  
36 cm/14"



¼

**Simpson-Luikart**  
BS09-387-36  
36 cm/14"



¼

**De Lee**  
BS09-389-30  
30 cm/12"



Obstetrical (Midwifery) Forceps

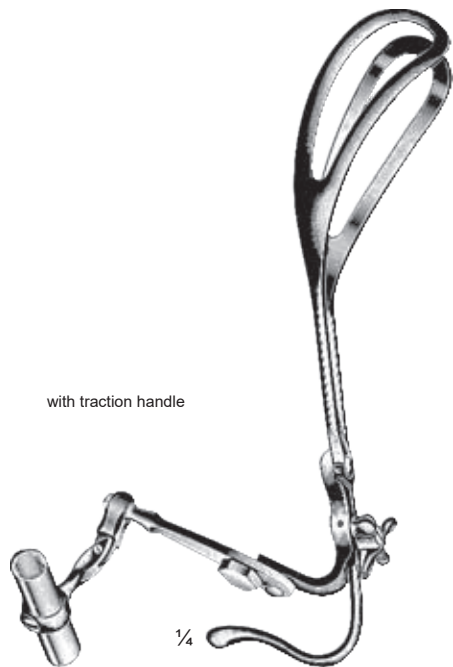

with traction handle

**Dewey**  
BS09-391-37  
37 cm/14 1/2"

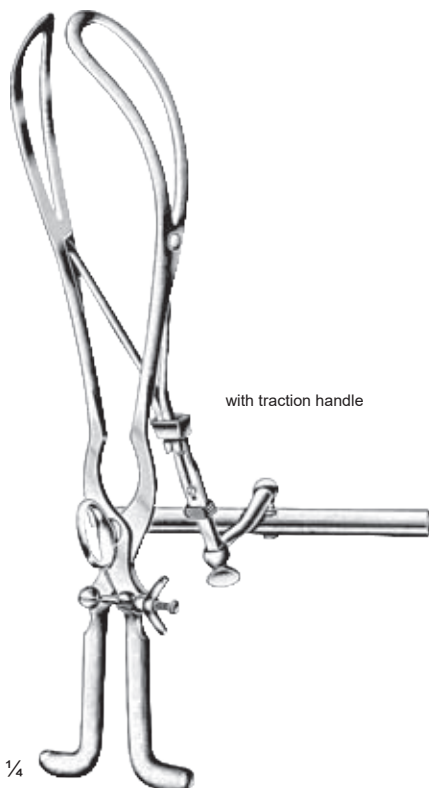

with traction handle

**Tarnier**  
BS09-393-40  
40 cm/15 3/4"



with traction handle

**Piper**  
BS09-395-40  
40 cm/15 3/4"



1/4

1/4

**Hirst**  
BS09-397-26  
26 cm/10 1/4"

**Barton**  
BS09-399-36  
36 cm/14"

Traction Handle for  
obstetrical forceps  
BS09-399-36



1/4

**Barton**  
BS09-401-17  
17 cm/6 3/4"



specifically for  
obstetrics in breech  
presentation

1/4

**Piper**  
BS09-403-44  
44 cm/17 1/4"



¼  
**Kielland**  
BS09-405-41  
41 cm/16"



¼  
**Kielland-Luikart**  
BS09-407-40  
40 cm/15 ¾"



¼  
**Luikart**  
BS09-409-40  
40 cm/15 ¾"



¼  
**Mc Lean-Tucker**  
BS09-411-39  
39 cm/15 ½"



¼  
**Mc Lean-Luikart**  
BS09-413-39  
39 cm/15 ½"

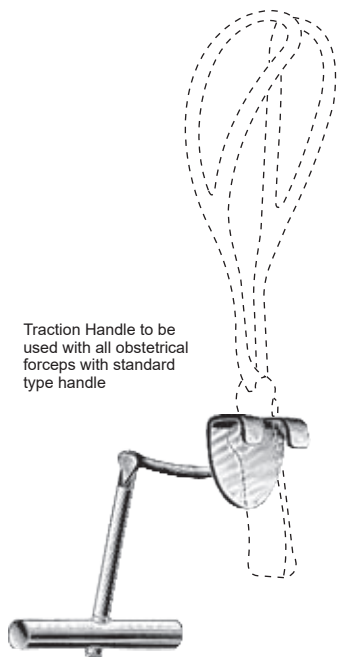

Traction Handle to be used with all obstetrical forceps with standard type handle

**Bill**  
BS09-415-20

Traction Handle for obstetrical forceps  
BS09-405-41 - BS09-409-40



¼  
**Luikart-Bill**  
BS09-417-21  
21 cm/8 ¼"

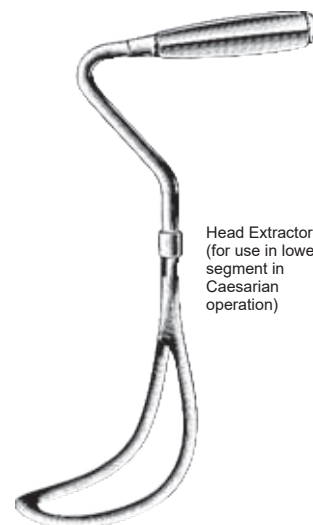

Head Extractor  
(for use in lower segment in Caesarian operation)

¼  
**Murless**  
BS09-419-26  
26 cm/10 ¼"

Placenta and Ovum Forceps, Scalp Flap Forceps, Elevating Spoon, etc.



**Saenger**  
BS09-421-27  
27 cm/10 1/2"

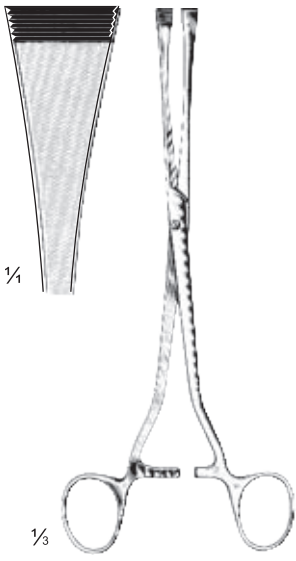

**Green-Armytage**  
BS09-425-21  
21 cm/8 1/4"  
Uterine Haemostasis Forceps,  
for use in lower segment in  
Caesarian operation



**Sellheim**  
BS09-427-28  
28 cm/11"  
Elevating Spoon,  
for movement of the head

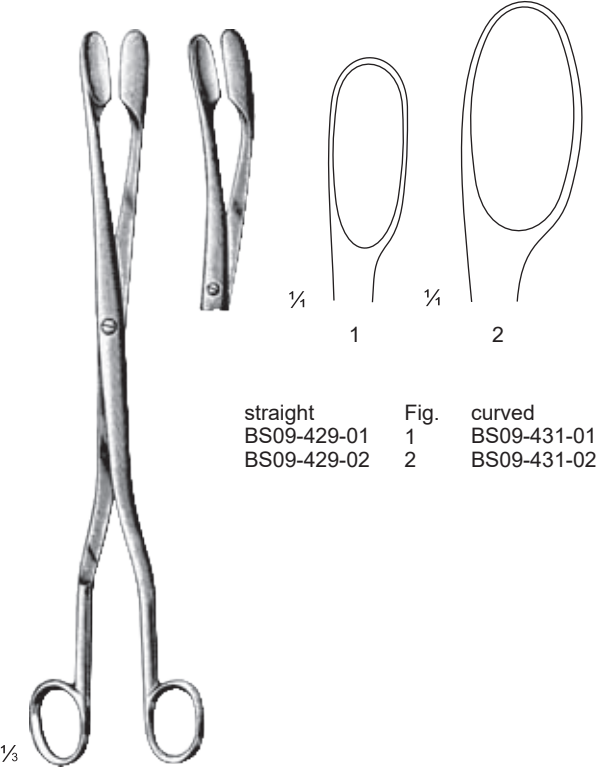

**Winter**  
28 cm/11"

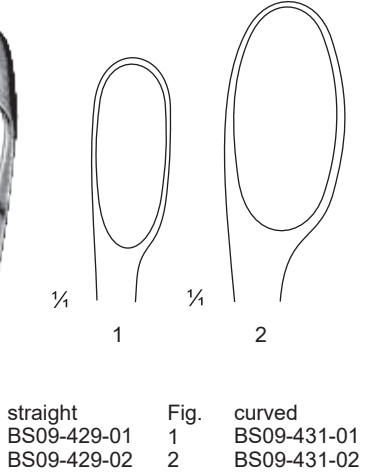

straight      Fig.      curved  
BS09-429-01    1      BS09-431-01  
BS09-429-02    2      BS09-431-02

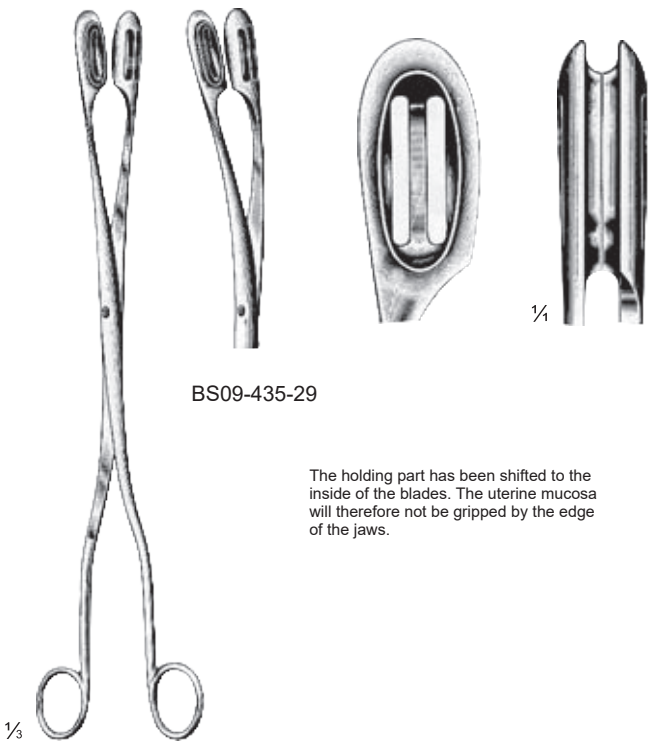

**Kranz**  
BS09-433-29  
29 cm/11 1/2"

The holding part has been shifted to the inside of the blades. The uterine mucosa will therefore not be gripped by the edge of the jaws.



Placenta and Ovum Forceps, Abortion Scoops



1/3  
**Corey (Greenhalg)**  
BS09-437-24  
24 cm/9 1/2"



1/4  
toothed back  
1/3  
**Cuzzi**  
30 cm/12"

14 1/2 mm



BS09-439-01

18 mm

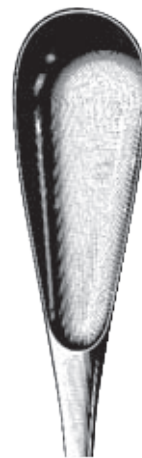

BS09-439-02

21 mm



BS09-439-03



1/3  
**Naegele**  
BS09-441-25  
25 cm/10"  
Perforators



1/3  
**Smellie**  
BS09-443-25  
25 cm/10"



1/4  
**BS09-445-02**  
blunt  
Placenta and Abortion Scoops

1/3  
**Wallich**  
42 cm/16 1/2"



**Kane**  
BS09-447-08  
8.5 cm/3 1/2"  
Umbilical Cord Clamps



**Collin**  
BS09-449-09  
9 cm/3 1/2"  
Umbilical Cord Clamps

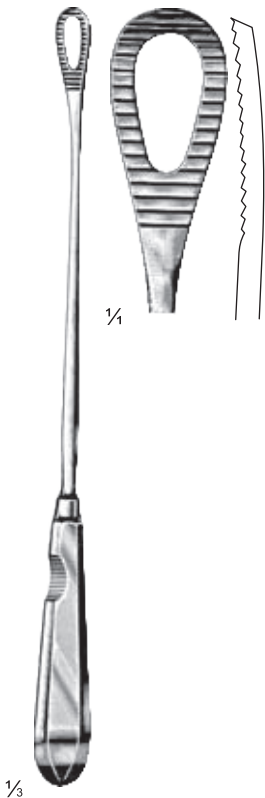

**Pestallozza**  
BS09-451-30  
30 cm/12"



**Braun**  
BS09-453-30  
30 cm/12"  
Decapitating Hook



**Braun**  
BS09-455-42  
42 cm/16 1/2"  
Cranioclast

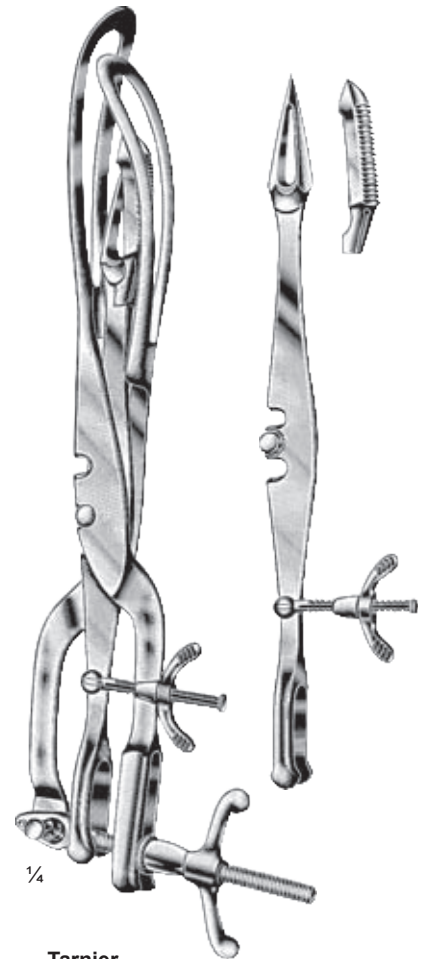

**Tarnier**  
BS09-457-46  
46 cm/18"  
Basiotribe