



Bone Surgery





Charriere
BS14-001-35
35 cm / 14"
with 2 saw blades,
12 and 15 mm wide

¼



Helferich-Bier
BS14-003-39
39 cm / 15½"
adjustable, with
3 saw blades, 3, 5
and 7 mm wide

¼



Rust
BS14-005-39
39 cm / 15½"
rotatable, with 4 saw
blades, 6, 8, 15 and
18 mm wide

¼



Linemann
BS14-007-20
20 cm / 8" ⅓



Langenbeck
BS14-009-23
23 cm / 9" ⅓

⅓



Charriere
BS14-011-27 = 27cm/10 ½"
BS14-011-30 = 30cm/12"
Blade Saws, interchangeable blades



Satterlee
BS14-013-31
31 cm / 12¼"
Blade Saws,
interchangeable blades

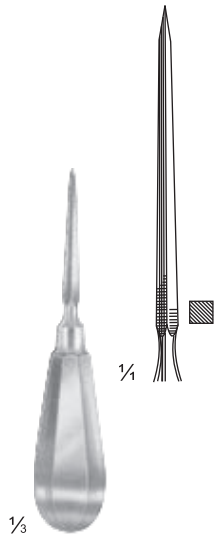

BS14-015-14
14cm / 5 1/2"



Perthes
BS14-017-21
21 cm / 8 1/4"



BS14-019-14
14 cm / 5 1/2"



Adson
BS14-021-15
15 cm / 6"
Drill Guide Dura
Protecting Forceps

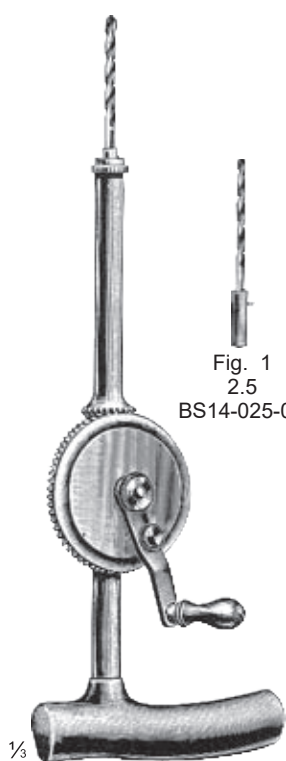

Stille-Sherman
BS14-023-00
24 cm / 9 1/2"
Hand Drill with 3 twist drills fig. 1-3

Twist Drills

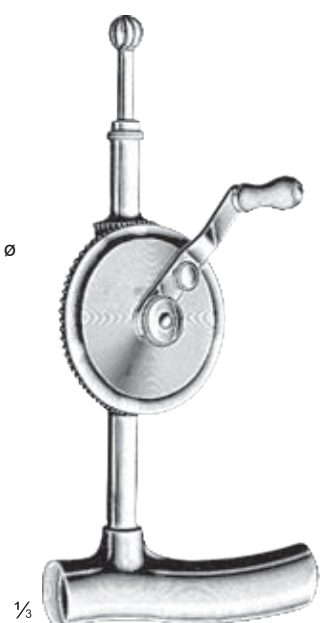
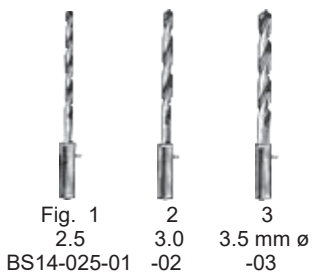

Stille
BS14-027-00
20 cm / 8"

Twist Drills and Spherical Burrs only

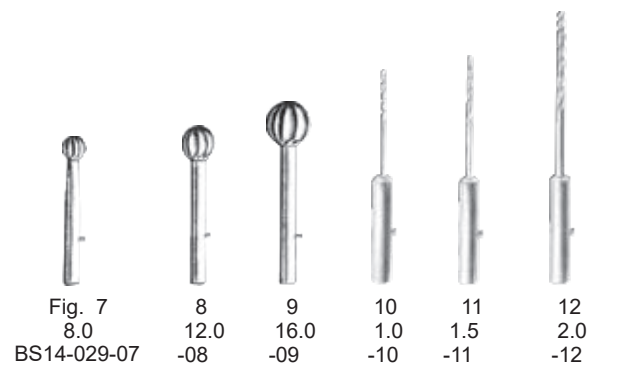
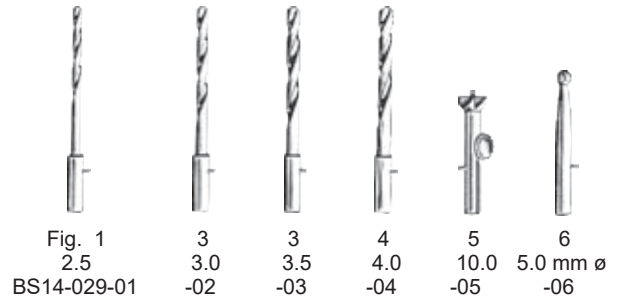

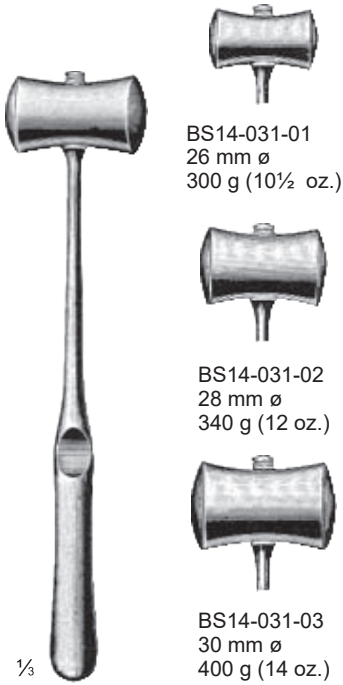

Williger
24 cm / 9½"
lead filled

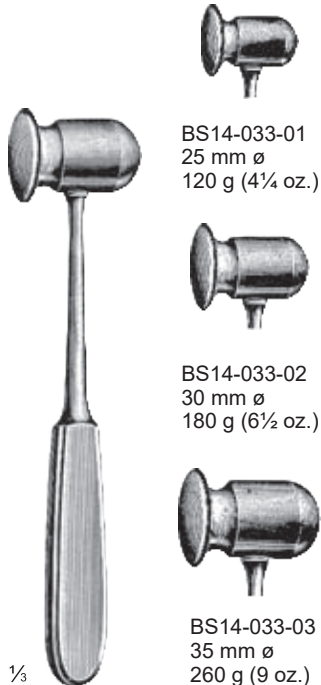

Doyen
21 cm / 8¼"
brass, solid

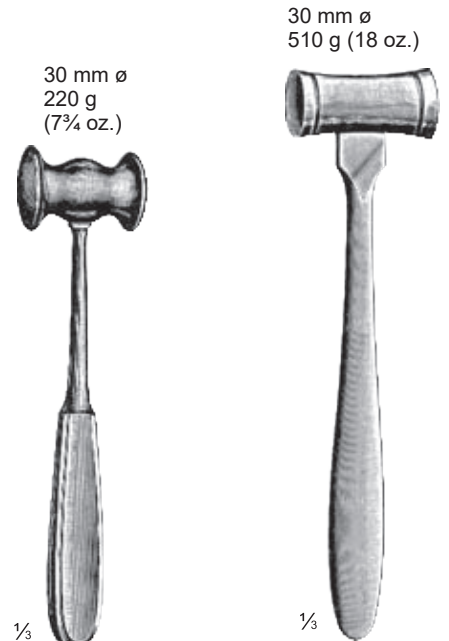

Collin
BS14-035-20
20 cm / 8"
brass, solid

BS14-037-22
22.5 cm / 9"
steel, solid



Mead
BS14-039-17
17 cm / 6¾"
solid
BS14-041-00
Ferrozell Cheeks
only, pair

with interchangeable
Ferrozell Cheeks



BS14-043-01
lead filled
BS14-043-02
brass, solid
16.5 cm / 6½"

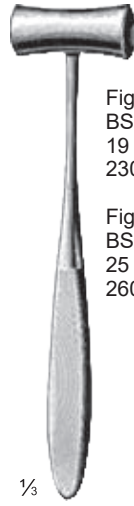

Lucae
19 cm / 7½"
brass, solid

Fig. 1
BS14-045-01
19 mm ø
230 g (8 oz.)

Fig. 2
BS14-045-02
25 mm ø
260 g (9 oz.)



BS14-047-24
24 cm / 9½"

steel, solid,
with plastic handle

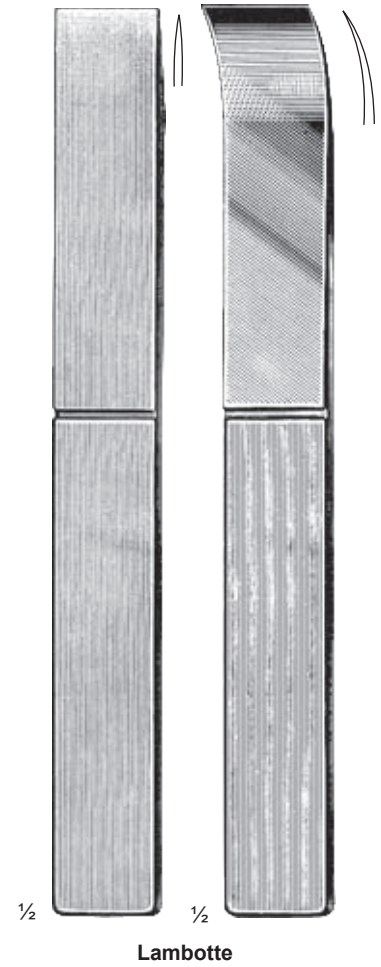

width		Smith-Petersen			
mm	20cm/8"	20cm/8"	20cm/8"	20cm/8"	
6	BS14-049-06	BS14-051-06			
9	BS14-049-09	BS14-051-09	BS14-053-09	BS14-055-09	
13	BS14-049-13	BS14-051-13			
14			BS14-053-14	BS14-055-14	
16	BS14-049-16	BS14-051-16			
19	BS14-049-19	BS14-051-19	BS14-053-19	BS14-055-19	
25	BS14-049-25	BS14-051-25	BS14-053-25	BS14-055-25	
32	BS14-049-32	BS14-051-32			

width		
mm	24 cm/9½"	23 cm/9"
15	BS14-057-15	BS14-059-15
20	BS14-057-20	BS14-059-20
25	BS14-057-25	BS14-059-25
30	BS14-057-30	BS14-059-30
38	BS14-057-38	BS14-059-38
44	BS14-057-44	BS14-059-44
50	BS14-057-50	BS14-059-50

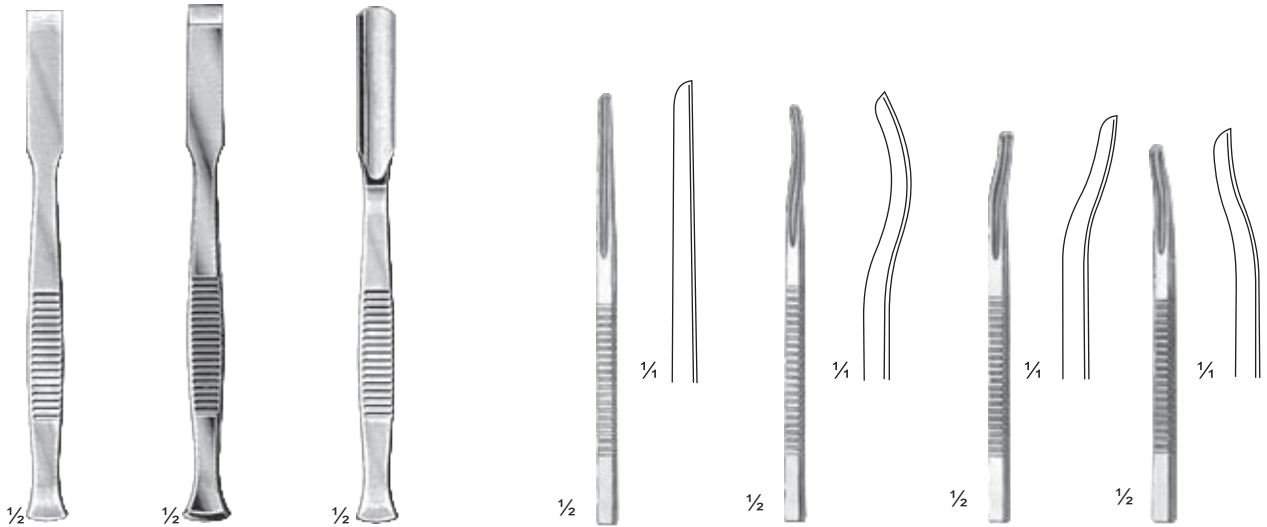

width mm	13.5 cm/5 1/4"	13.5 cm/5 1/4"	13.5 cm/5 1/4"
8	BS14-061-08	BS14-063-08	BS14-065-08
10	BS14-061-10	BS14-063-10	BS14-065-10
12	BS14-061-12	BS14-063-12	BS14-065-12
14	BS14-061-14	BS14-063-14	BS14-065-14
16	BS14-061-16	BS14-063-16	BS14-065-16

BS14-067-01 BS14-067-02 BS14-067-03 BS14-067-04

Buck-Gramcko

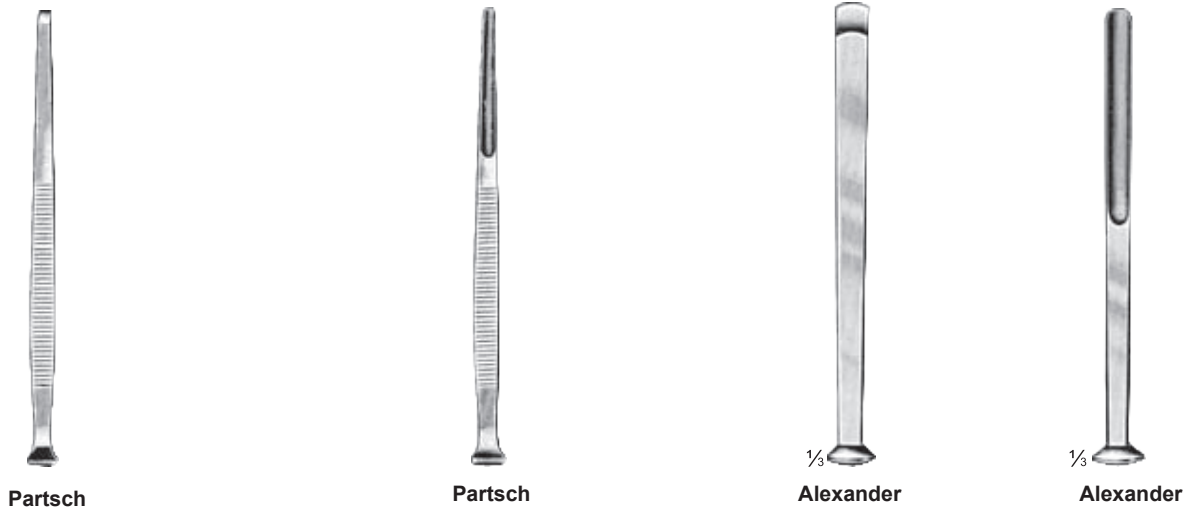

	width mm	width mm	width mm	width mm
11.5 cm/4 1/2"	13.5 cm/5 1/4"	11.5 cm/4 1/2"	13.5 cm/5 1/4"	
BS14-069-02	BS14-071-02	2	BS14-073-02	BS14-075-02
BS14-069-03	BS14-071-03	3	BS14-073-03	BS14-075-03
BS14-069-04	BS14-071-04	4	BS14-073-04	BS14-075-04
BS14-069-05	BS14-071-05	5	BS14-073-05	BS14-075-05
BS14-069-06	BS14-071-06	6	BS14-073-06	BS14-075-06
BS14-069-07	BS14-071-07	7	BS14-073-07	BS14-075-07
BS14-069-08	BS14-071-08	8	BS14-073-08	BS14-075-08

	width mm	width mm
18 cm/7"	18 cm/7"	
BS14-077-04	4	BS14-079-04
BS14-077-06	6	BS14-079-06
BS14-077-08	8	BS14-079-08
BS14-077-10	10	BS14-079-10
BS14-077-12	12	BS14-079-12
BS14-077-14	14	BS14-079-14



Stille

width mm	20 cm/8"	20 cm/8"	20 cm/8"
10	BS14-081-10	BS14-083-10	BS14-085-10
15	BS14-081-15	BS14-083-15	BS14-085-15
20	BS14-081-20	BS14-083-20	BS14-085-20
25	BS14-081-25	BS14-083-25	BS14-085-25



Hoke

width mm	17 cm/ 6 3/4"
3	BS14-087-03
5	BS14-087-05
6	BS14-087-06
8	BS14-087-08
9	BS14-087-09

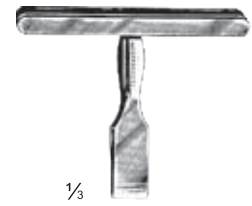

Virchow
BS14-089-00

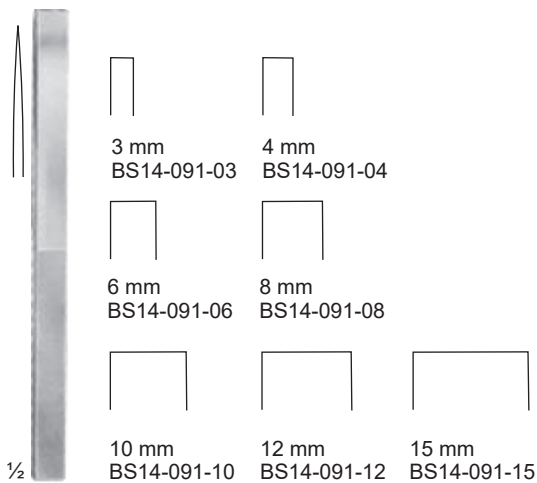

Mini-Lambotte
12.5 cm / 5"



Brunetti
BS14-093-28
28 cm / 11"



Brunetti
BS14-095-28
28 cm / 11"



BS14-097-15 = 15 mm
BS14-097-18 = 18 mm
BS14-097-22 = 22 mm
13.5 cm / 5 1/2"

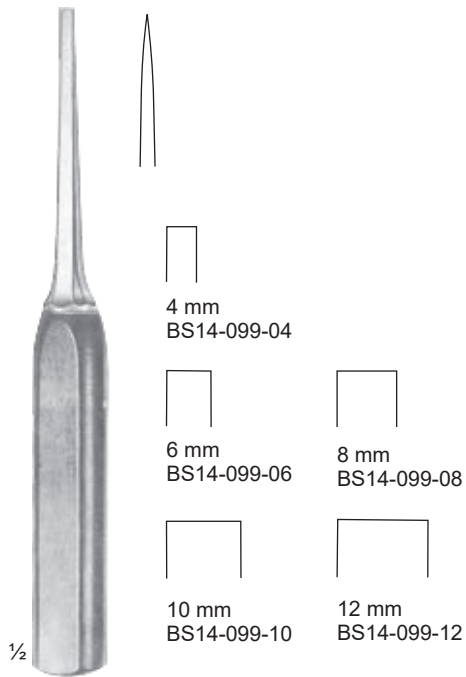

Mini-Lexer
18 cm / 7"

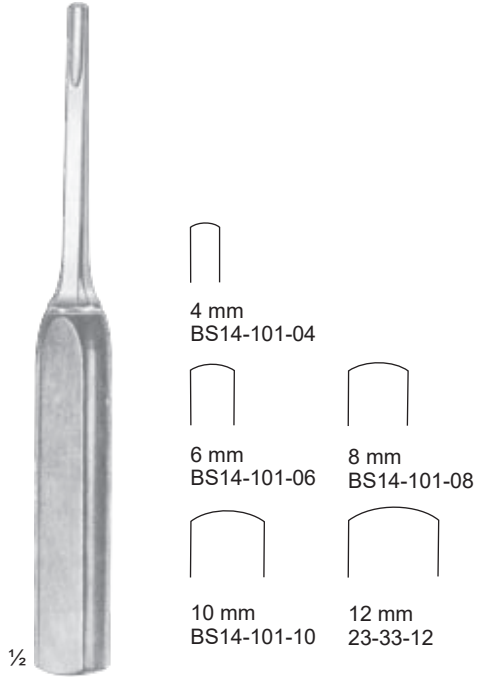

Mini-Lexer
18 cm / 7"

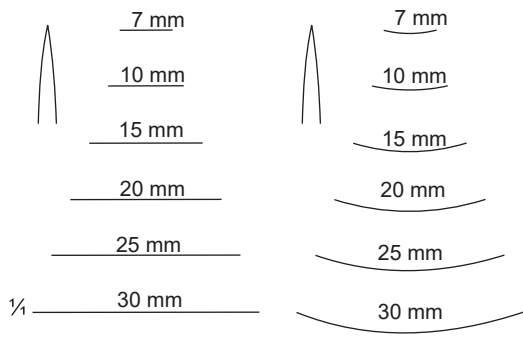

width mm	22 cm/8 1/2"	22 cm/8 1/2"
07	BS14-103-07	BS14-105-07
10	BS14-103-10	BS14-105-10
15	BS14-103-15	BS14-105-15
20	BS14-103-20	BS14-105-20
25	BS14-103-25	BS14-105-25
30	BS14-103-30	BS14-105-30



Lexer
BS14-103-07- BS14-105-07-
BS14-103-30 BS14-105-30



Periosteotomes, Chisels and Gouges
Chisels for Oral and Maxillo-Facial Surgery

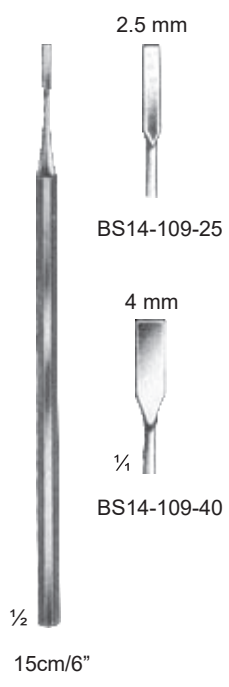

for sectioning of Alveolar Process between two roots

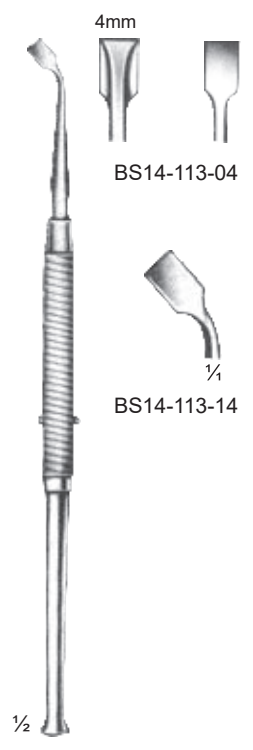
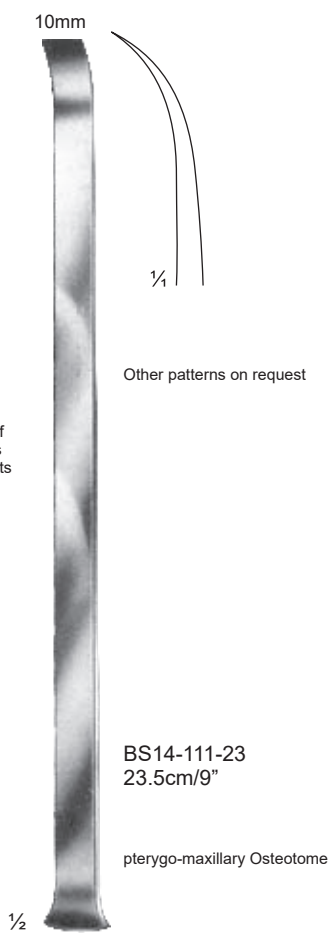

Freer
19cm/7 1/2"



Freer
BS14-115-14
16cm/6 1/4"



Freer
BS14-115-16
16cm/6 1/4"



Freer
BS14-117-15
15cm/6"



West
BS14-119-16
16cm/6 1/4"



West
BS14-121-16
16cm/6 1/4"





Carroll (French Pattern)
14.5cm/5 3/4"

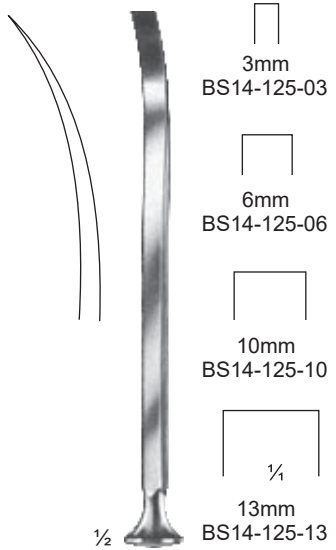

Carroll (French Pattern)
14.5cm/5 3/4"

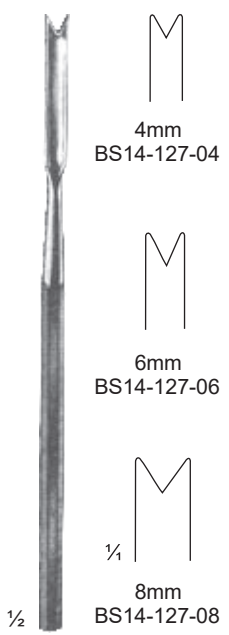

Ballenger
15cm/6"



Killian
BS14-129-05
16cm/6 1/4"



Killian
BS14-131-05
16cm/6 1/4"

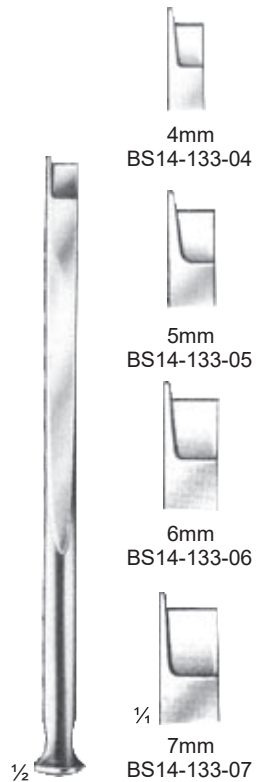

Fomon
14.5cm/5 3/4"

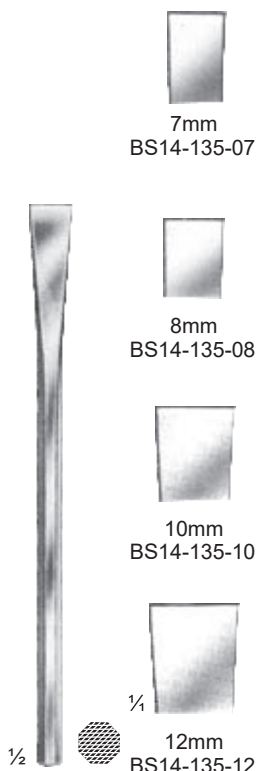

Sheehan
15cm/6"

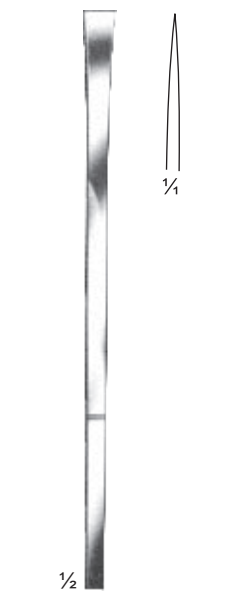

Cottle
15cm/6"
7mm BS14-137-07
12mm BS14-137-12



Cottle
18cm/7"
4mm BS14-139-04
6mm BS14-139-06
7mm BS14-139-07
9mm BS14-139-09
12mm BS14-139-12



Cottle
BS14-141-06
18cm/7"

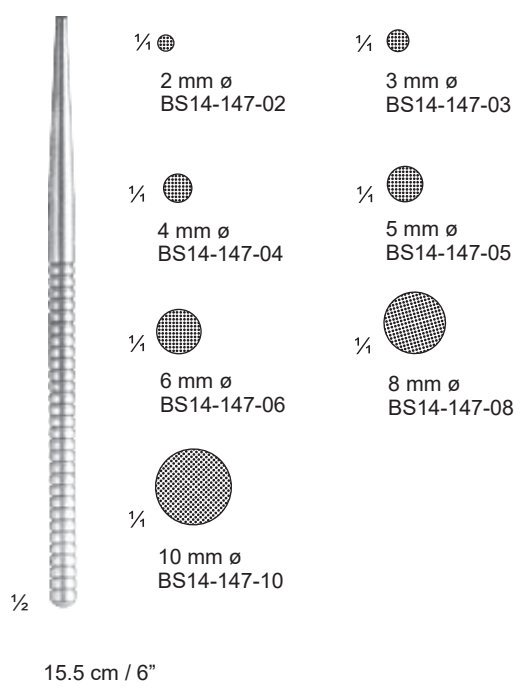

width		Hibbs			
mm	24 mc/9½"	24 mc/9½"	24 mc/9½"	24 mc/9½"	24 mc/9½"
6	BS14-149-06	BS14-151-06	BS14-153-06	BS14-155-06	BS14-157-06
13	BS14-149-13	BS14-151-13	BS14-153-13	BS14-155-13	BS14-157-13
19	BS14-149-19	BS14-151-19	BS14-153-19	BS14-155-19	BS14-157-19
25	BS14-149-25	BS14-151-25	BS14-153-25	BS14-155-25	BS14-157-25
32	BS14-149-32	BS14-151-32	BS14-153-32	BS14-155-32	BS14-157-32



Cobb
BS14-159-08
28cm/11"



Cobb
BS14-160-28
28cm/11"



Cobb
BS14-161-48
28cm/11"



Cobb
BS14-162-68
28cm/11"



25cm/10"
5mm BS14-163-05
10mm BS14-163-10
15mm BS14-163-15



25cm/10"
5mm BS14-164-05
10mm BS14-164-10
15mm BS14-164-15



Zielke
23cm/9"
5.5mm BS14-165-05
9.0mm BS14-165-90



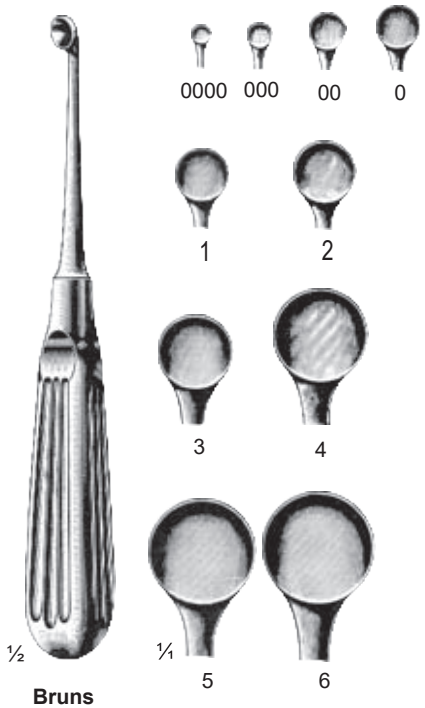

Brun's

- BS14-167-30
- BS14-167-20
- BS14-167-10

- BS14-169-01
- BS14-169-02
- BS14-169-03

- BS14-169-04
- BS14-169-05
- BS14-169-06

Fig.

- 000
- 00
- 0

- 1
- 2
- 3

- 4
- 5
- 6

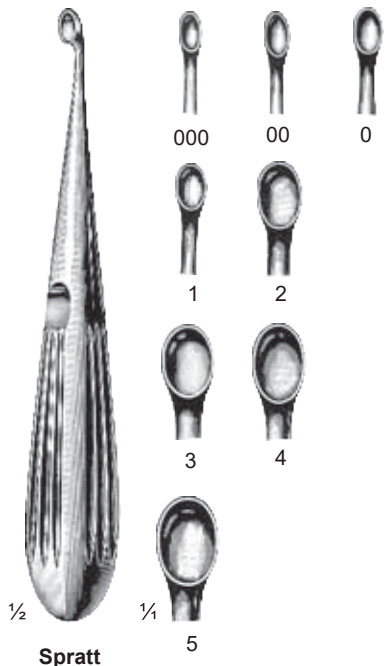

Spratt

- BS14-171-30
- BS14-171-20
- BS14-171-10

- BS14-173-01
- BS14-173-02
- BS14-173-03

- BS14-173-04
- BS14-173-05

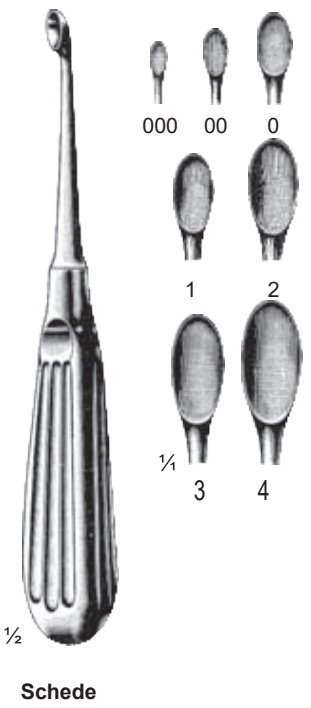

Schede

- BS14-175-30
- BS14-175-20

- BS14-175-10
- BS14-177-01
- BS14-177-02

- BS14-177-03
- BS14-177-04

Fig.

- 0000
- 000
- 00

- 0
- 1
- 2

- 3
- 4
- 5
- 6

Volkman

- BS14-179-40
- BS14-179-30
- BS14-179-20

- BS14-179-10
- BS14-181-01
- BS14-181-02

- BS14-181-03
- BS14-181-04
- BS14-181-05
- BS14-181-06

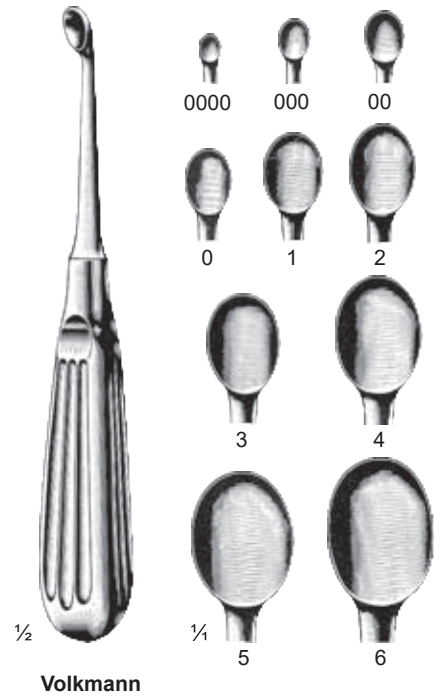

Volkman



Bone Curettes



Mod. USA
16 cm / 6 1/4"

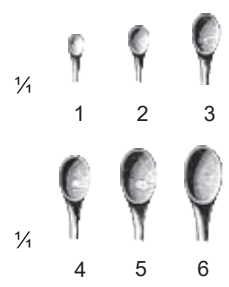
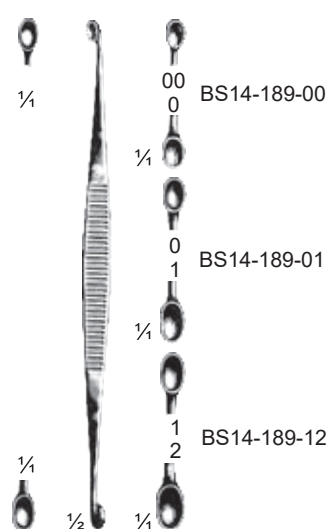
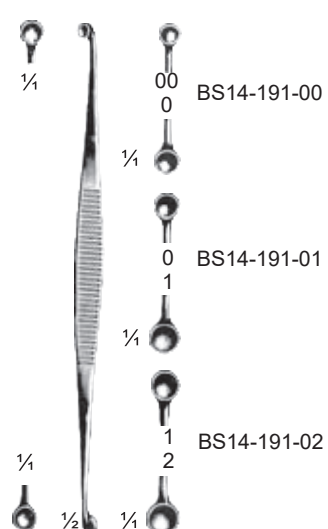

Fig.	straight	right curved	left curved
1	BS14-183-01	BS14-185-01	BS14-187-01
2	BS14-183-02	BS14-185-02	BS14-187-02
3	BS14-183-03	BS14-185-03	BS14-187-03
4	BS14-183-04	BS14-185-04	BS14-187-04
5	BS14-183-05	BS14-185-05	BS14-187-05
6	BS14-183-06	BS14-185-06	BS14-187-06



Williger
13.5 cm / 5 1/4"



Martini
13.5 cm / 5 1/4"



Williger
17.5 cm / 7"

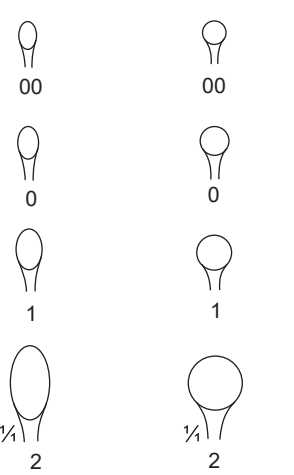

Fig.	straight, oval	straight, round
BS14-193-20	00	BS14-197-20
BS14-193-10	0	BS14-197-10
BS14-195-01	1	BS14-199-01
BS14-195-02	2	BS14-199-02



Bruns
23 cm / 9"



Simon
24 cm / 9 1/2"

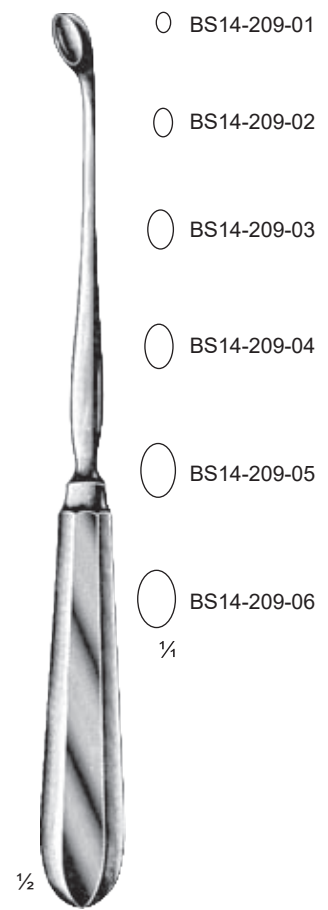

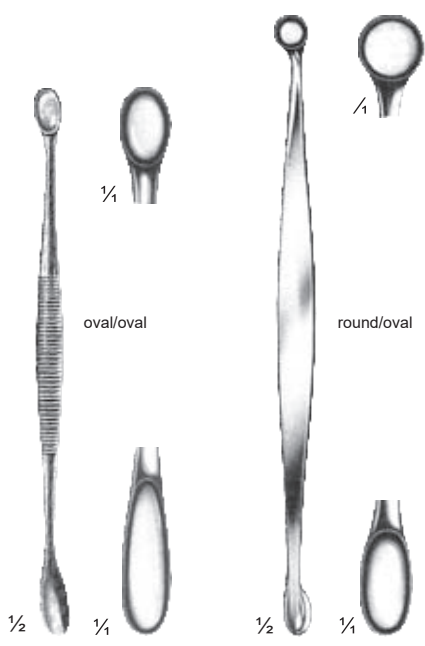

Volkmann		Volkmann	
cm	inch		
13	5	BS14-211-13	BS14-213-13
14.5	5 1/2	BS14-211-14	
16	6 1/4		BS14-213-16
17	6 3/4	BS14-211-17	
20	8	BS14-211-20	BS14-213-20

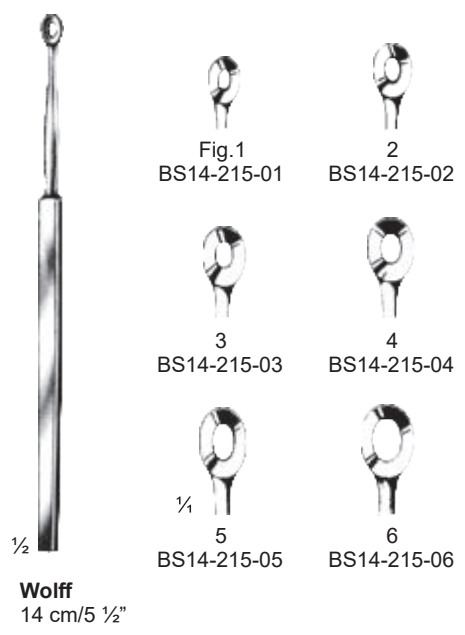

Wolff
14 cm/5 1/2"

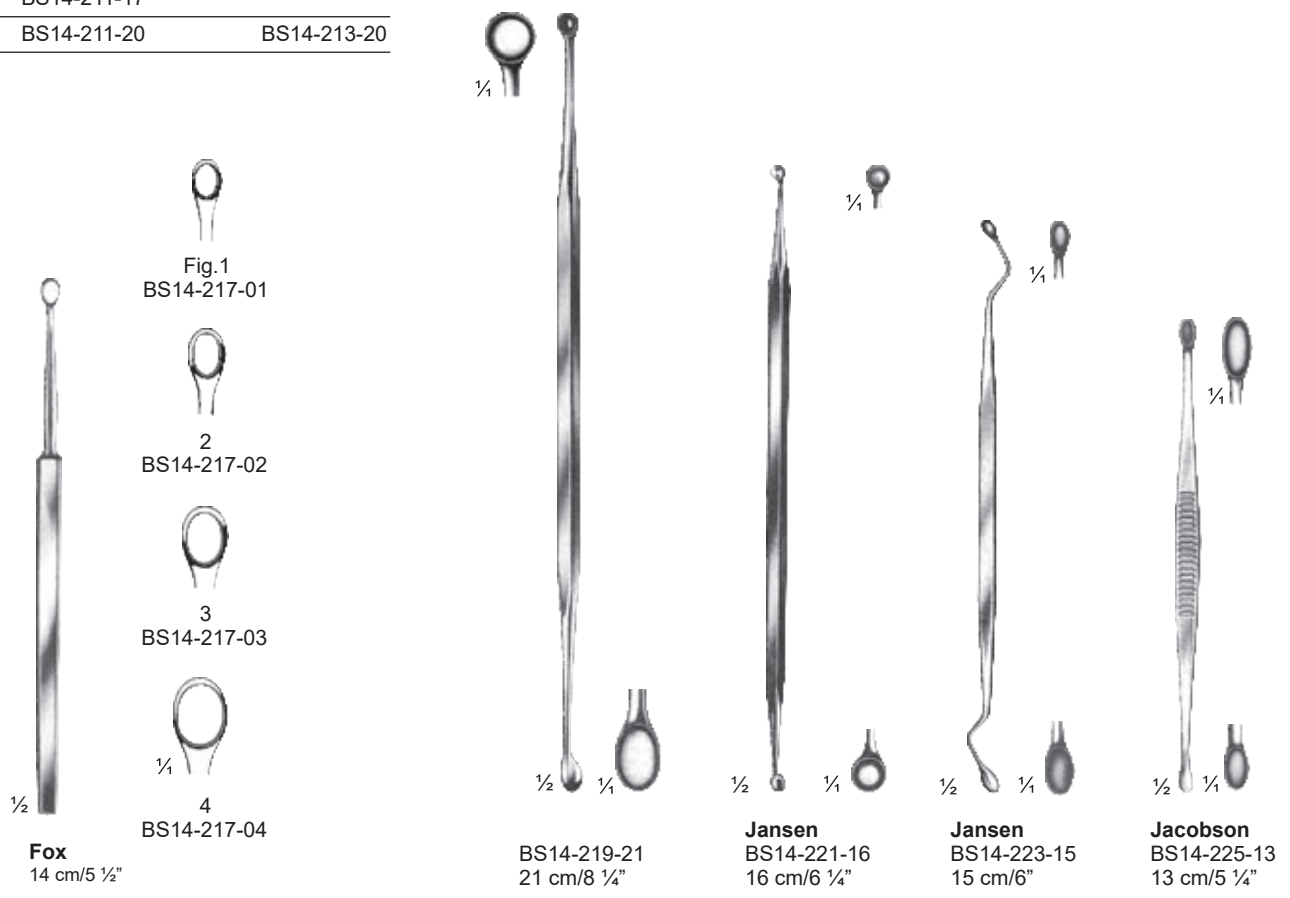

Fox
14 cm/5 1/2"

BS14-219-21
21 cm/8 1/4"

Jansen
BS14-221-16
16 cm/6 1/4"

Jansen
BS14-223-15
15 cm/6"

Jacobson
BS14-225-13
13 cm/5 1/4"



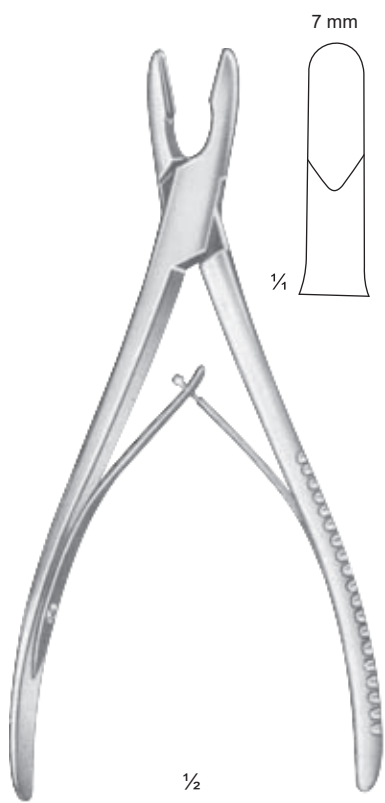

Adson
BS14-227-20
20cm/8"

Laminectomy Rongeurs



19cm/7 1/2"



24cm/9 1/2"



24cm/9 1/2"

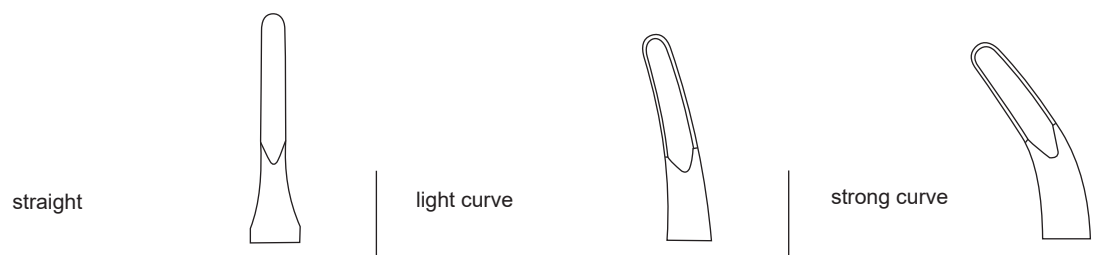

	straight		light curve		strong curve	
	3mm	4mm	3mm	4mm	3mm	4mm
Smith-Peterson						
19cm/7 1/2"	BS14-229-03	BS14-229-04	BS14-229-13	BS14-229-14	BS14-229-23	BS14-229-24
24cm/9 1/2"	BS14-231-03	BS14-231-04	BS14-231-13	BS14-231-14	BS14-231-23	BS14-231-24
Fulton	5mm	6mm	5mm	6mm	5mm	6mm
19cm/7 1/2"	BS14-229-05	BS14-229-06	BS14-229-15	BS14-229-16	BS14-229-25	BS14-229-26
24cm/9 1/2"	BS14-231-05	BS14-231-06	BS14-231-15	BS14-231-16	BS14-231-25	BS14-231-26

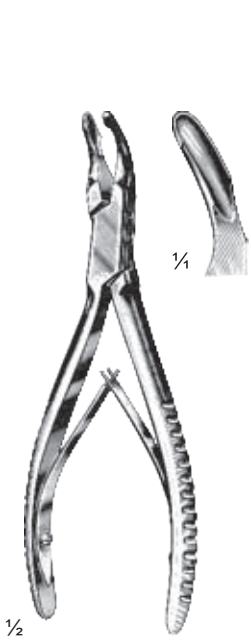

Cleveland
BS14-233-14
14 cm/5 1/2"



Cleveland
BS14-235-17
17 cm/6 3/4"

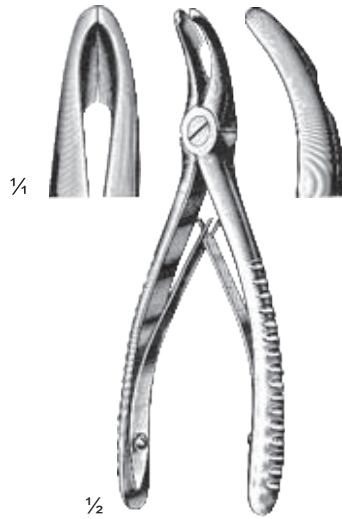

Universal
BS14-237-13
13.5 cm/5 1/4"

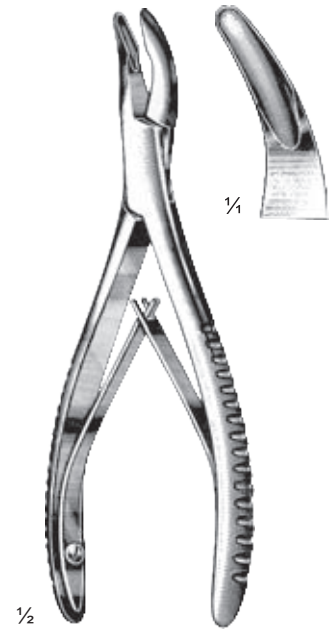

Mead
BS14-239-16
16.5 cm/6 1/2"



Leksell-Stille
24 cm/9 1/2"

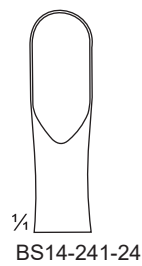

BS14-241-24

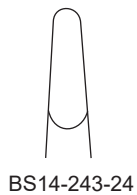

BS14-243-24

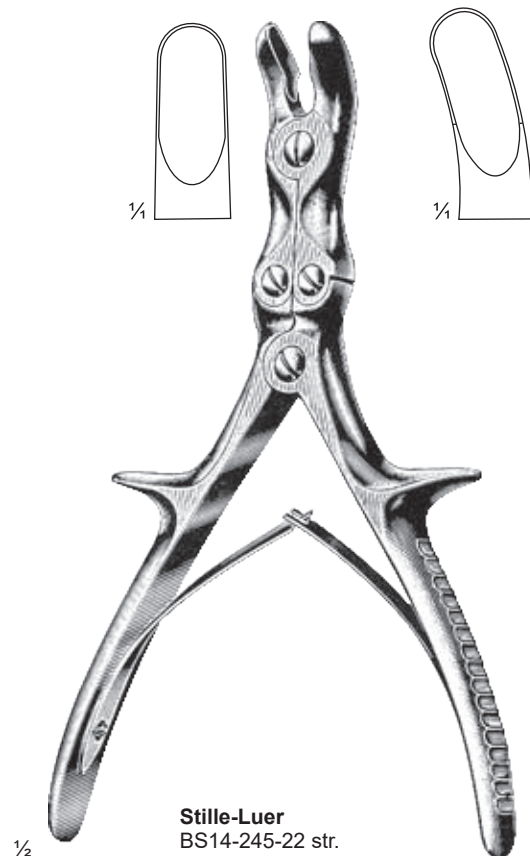

Stille-Luer
BS14-245-22 str.
BS14-247-22 cvd.
22cm/8 3/4"

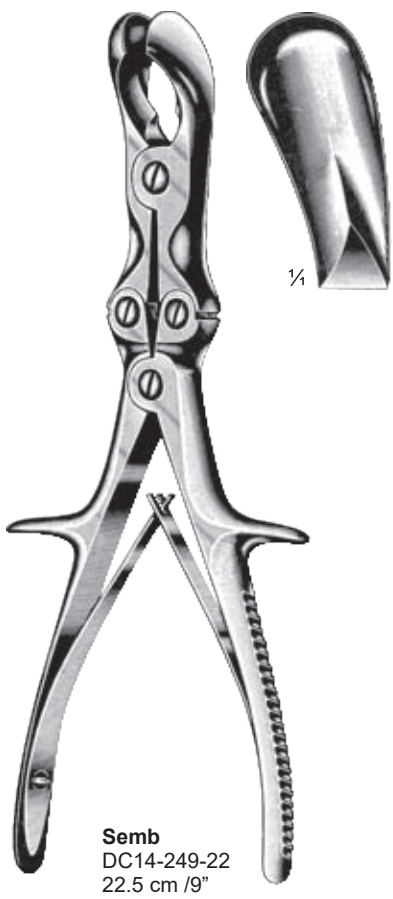

Semb
DC14-249-22
22.5 cm / 9"



Stille
DC14-251-23
23 cm / 9"



Stille-Ruskin
DC14-253-23
23 cm / 9"

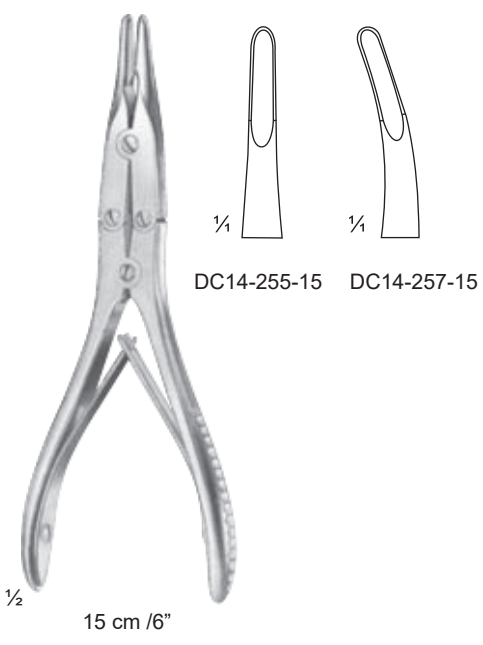

DC14-255-15 DC14-257-15

15 cm / 6"



Beyer
DC14-259-18
18 cm / 7"



Zaufal-Jansen
DC14-261-18
18 cm / 7"

Bone Rongeur Forceps



1/4
BS14-263-23
23cm/9"
BS14-263-27
27cm/10 1/2"



Stille-Luer



BS14-265-23
23cm/9"
BS14-265-27
27cm/10 1/2"

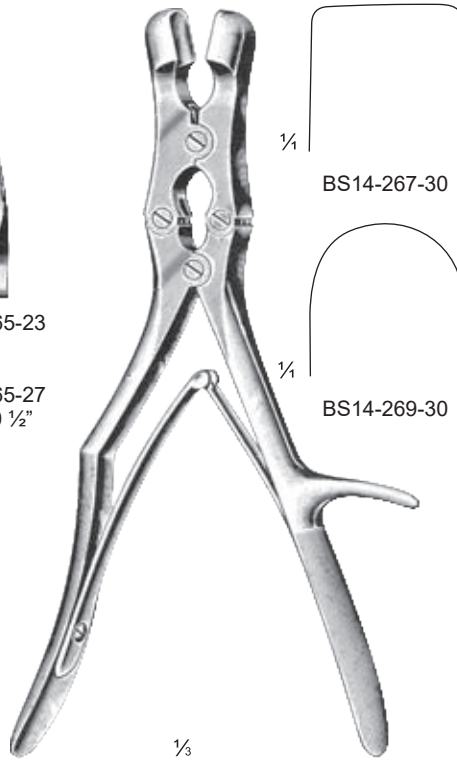

Sauerbruch
30 cm /12"



Lempert
BS14-271-19
19 cm/7 1/2"

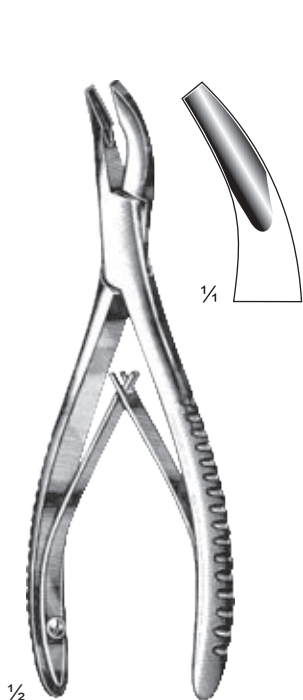

Mead
BS14-273-16
16.5 cm/6 1/2"



Hartmann
BS14-275-18
18.5 cm/7 1/4"

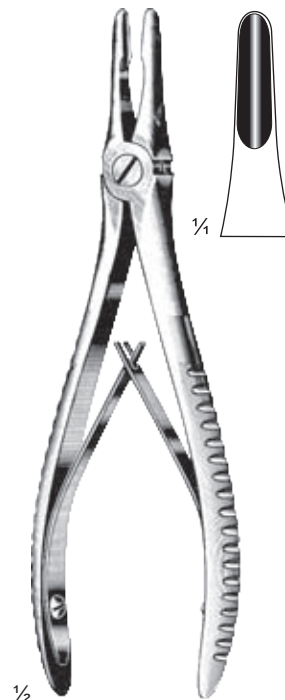

Jansen
BS14-277-18
18 cm/7"

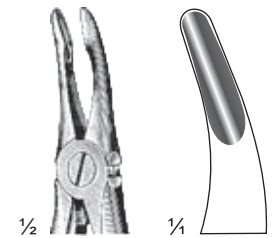

BS14-279-18

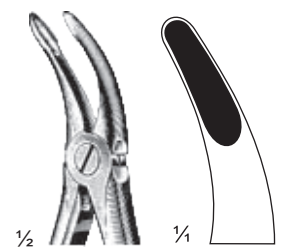

BS14-281-18



Ruskin
BS14-283-23
23 cm / 9"



Ruskin
BS14-285-18
18 cm / 7"



Stellbrink
17 cm / 6 3/4"

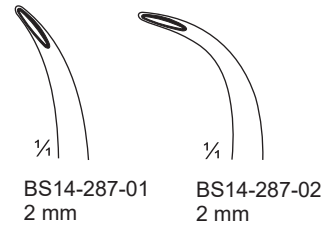

BS14-287-01
2 mm

BS14-287-02
2 mm



Blumenthal
BS14-289-15
15.5 cm / 6"



Blumenthal
BS14-291-15
15.5 cm / 6"



Friedman
BS14-293-14
14 cm / 5 1/2"



Mini-Friedman
BS14-295-12
12 cm / 5"



Luer
BS14-297-15
15 cm/6"

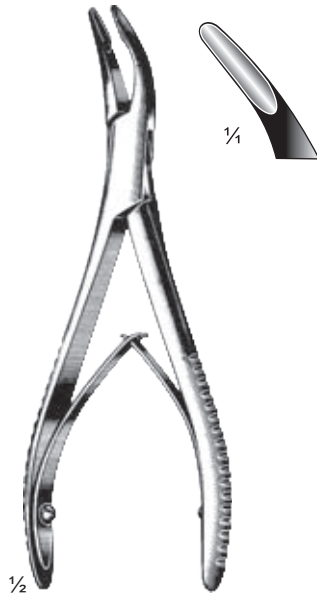

Luer
BS14-299-15
15 cm/6"

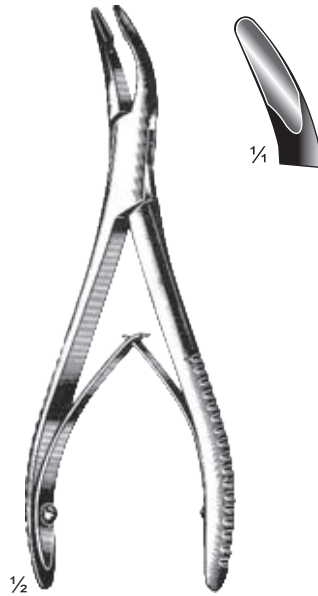

Luer
BS14-301-15
15 cm/6"



BS14-303-18
18 cm/7"

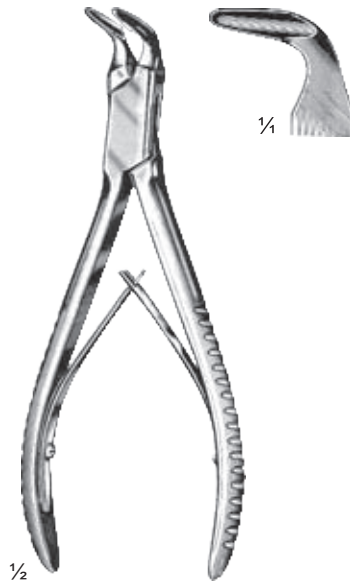

Blumenthal
BS14-305-15
15.5 cm/6"

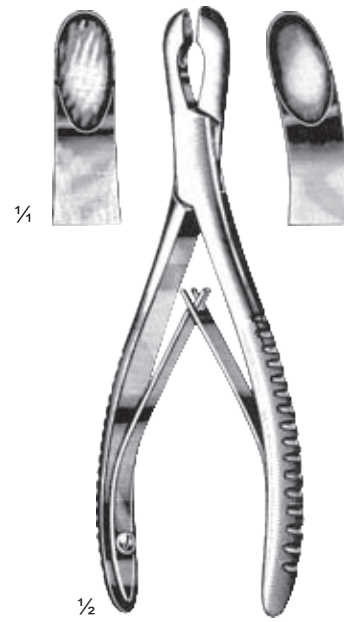

Luer
BS14-307-17 str.
BS14-309-17 cvd.
17 cm/6 3/4"

Bone Cutting Forceps

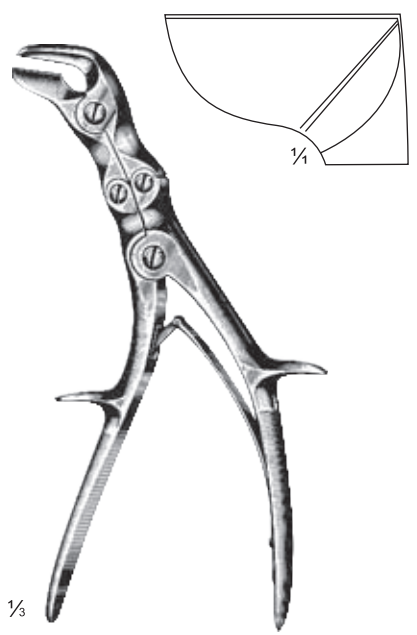

Semb
BS14-311-24
24 cm/9 1/2"



Ruskin-Liston
BS14-313-18
18.5 cm/7 1/4"

Ruskin-Liston
BS14-315-18
18.5 cm/7 1/4"



Liston-Key
BS14-317-27
27 cm/10 1/2"

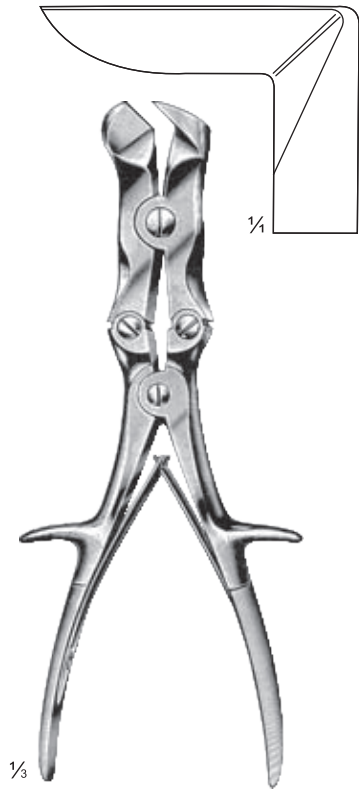

Stille-Liston
BS14-319-27
27 cm/10 1/2"

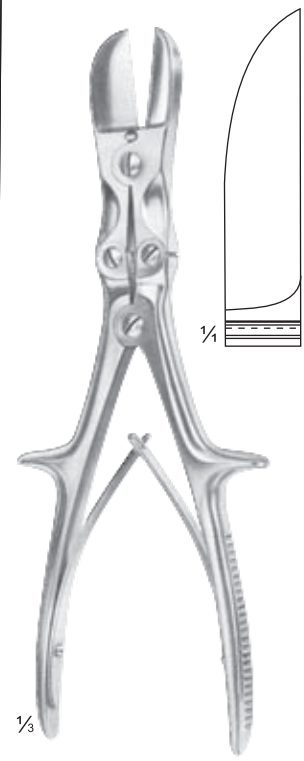

Stille-Liston
BS14-321-27
27 cm/10 1/2"

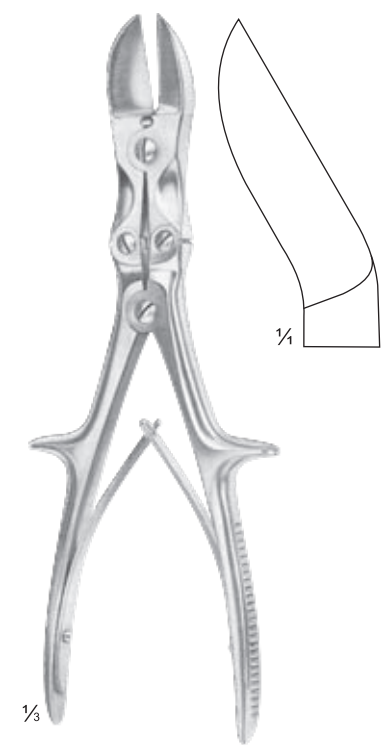

Stille-Liston
BS14-323-27
27 cm/10 1/2"



BS14-325-15
15 cm/5 3/4"

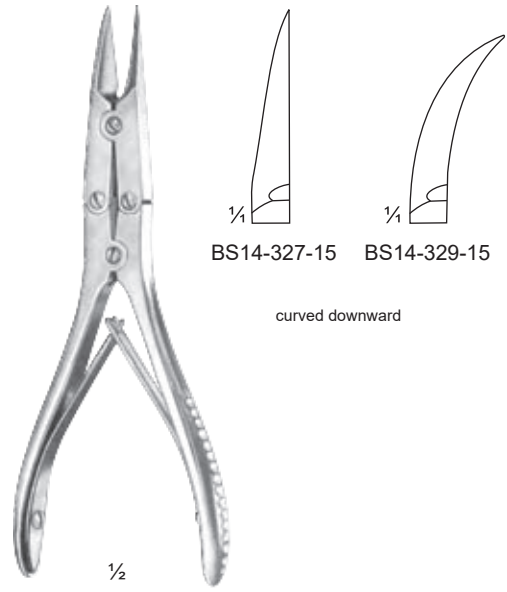

BS14-327-15 BS14-329-15

1/2
15 cm/5 3/4"



BS14-331-12
12 cm/4 3/4"

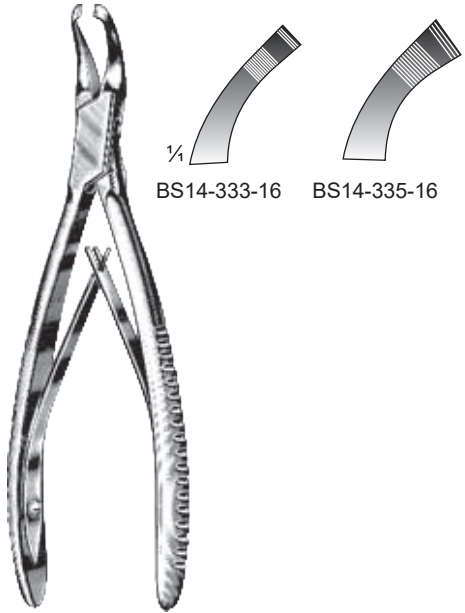

BS14-333-16 BS14-335-16

1/2
Cleveland
16 cm/6 1/4"



1/2
Cleveland
BS14-337-15
15 cm/6"

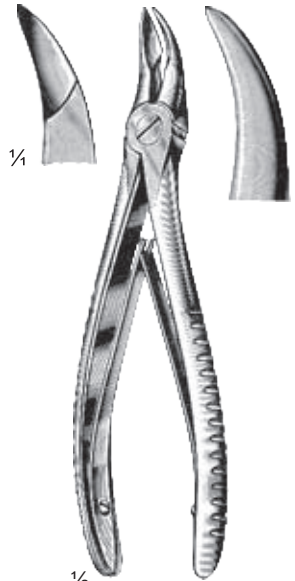

BS14-339-15
15 cm/6"



BS14-341-01
Child Size
BS14-341-02
Adult Size

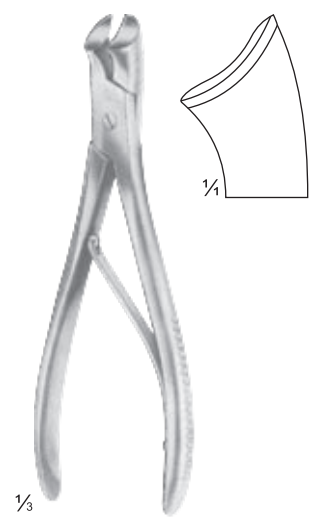

Markwalder
BS14-343-20
20 cm / 8"

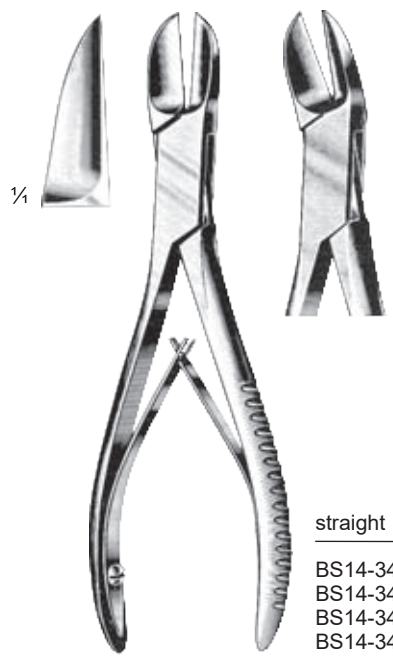

Liston

	straight	cm	in.	curved
	BS14-345-14	14	5½	BS14-347-14
	BS14-345-17	17	6¾	BS14-347-17
	BS14-345-19	19	7½	BS14-347-19
	BS14-345-22	22	8¾	BS14-347-22



Cleveland
BS14-349-17
17 cm / 6¾"



Cottle Kazanjian
BS14-351-19
19 cm / 7½"

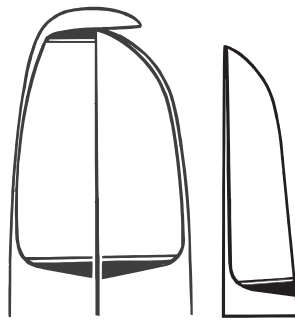
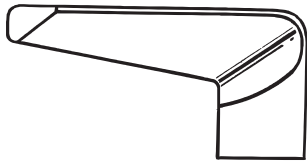

For the left hand

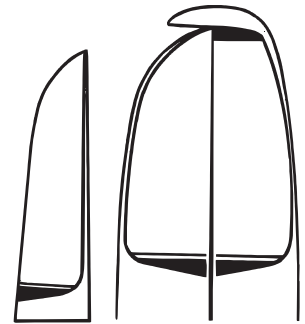

For the right hand



Roos
BS14-357-33
33cm/13"



Coryllos-Bethune
BS14-359-35
35cm/13 3/4"



Coryllos-Bethune
BS14-361-35
35cm/13 3/4"



1/4
Stille-Giertz
BS14-363-25
24.5cm/9 3/4"



1/4
Sauerbruch
BS14-365-23 = 23cm/9"
BS14-365-26 = 26cm/10 1/4"



Sternum Shears

1/4
Lebsche
BS14-373-25
25cm/10"



With eccentric sliding blade

Gluck
BS14-375-19 = 19cm/7 1/2"
BS14-375-22 = 22cm/8 3/4"

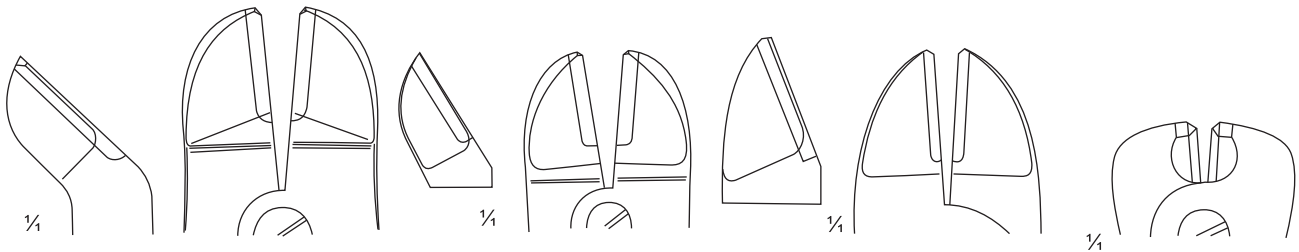

Muller-Claus
BS14-377-22
22cm/8 3/4"



Muller-Claus
BS14-379-16 16cm/6 1/4"
BS14-379-18 18cm/7"



BS14-381-20
20cm/8"



BS14-383-18
18cm/7"



BS14-385-17 17cm/6 3/4"
BS14-385-20 20cm/8"

Mayo-Hauberisser

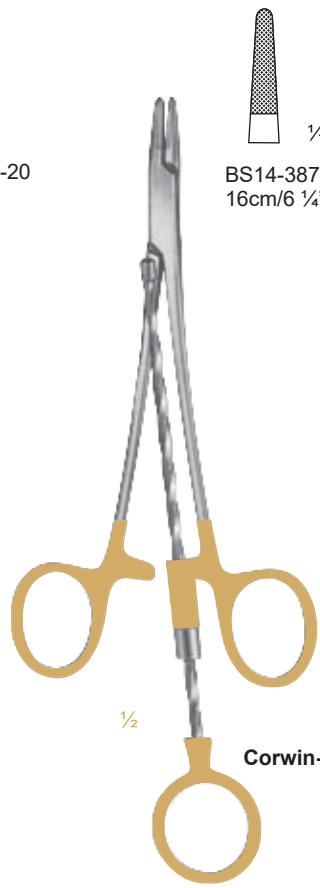

BS14-387-16 16cm/6 1/4"
BS14-389-16 16cm/6 1/4"
BS14-391-16 16cm/6 1/4"

Corwin-Hegar

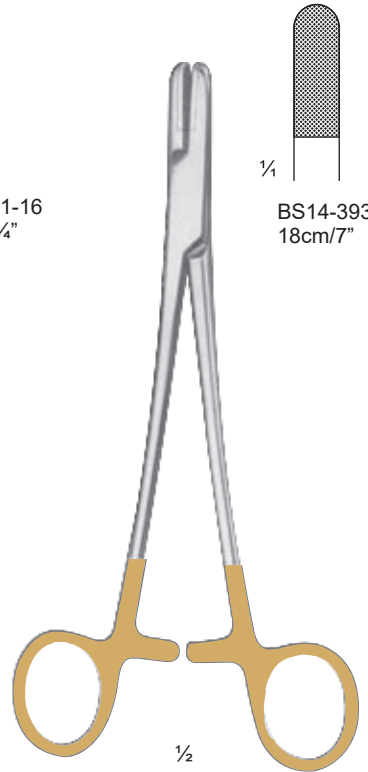

BS14-393-18 18cm/7"

Berry



BS14-395-16 16cm/6 1/4"
BS14-397-16 16cm/6 1/4"
BS14-399-16 16cm/6 1/4"

Mayo-Hauberisser



2mm
BS14-401-18 18cm/7"

1/2

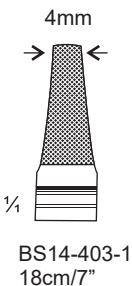

4mm
BS14-403-18 18cm/7"

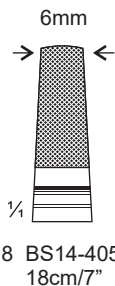

6mm
BS14-405-18 18cm/7"



BS14-407-20 20cm/8"

1/2





BS14-409-14
13.5 cm / 5 1/4"

Langenbeck
BS14-411-21
21 cm / 8 1/4"

Fergusson
BS14-413-21
21 cm / 8 1/4"

Frosch
BS14-415-18
18 cm / 7"

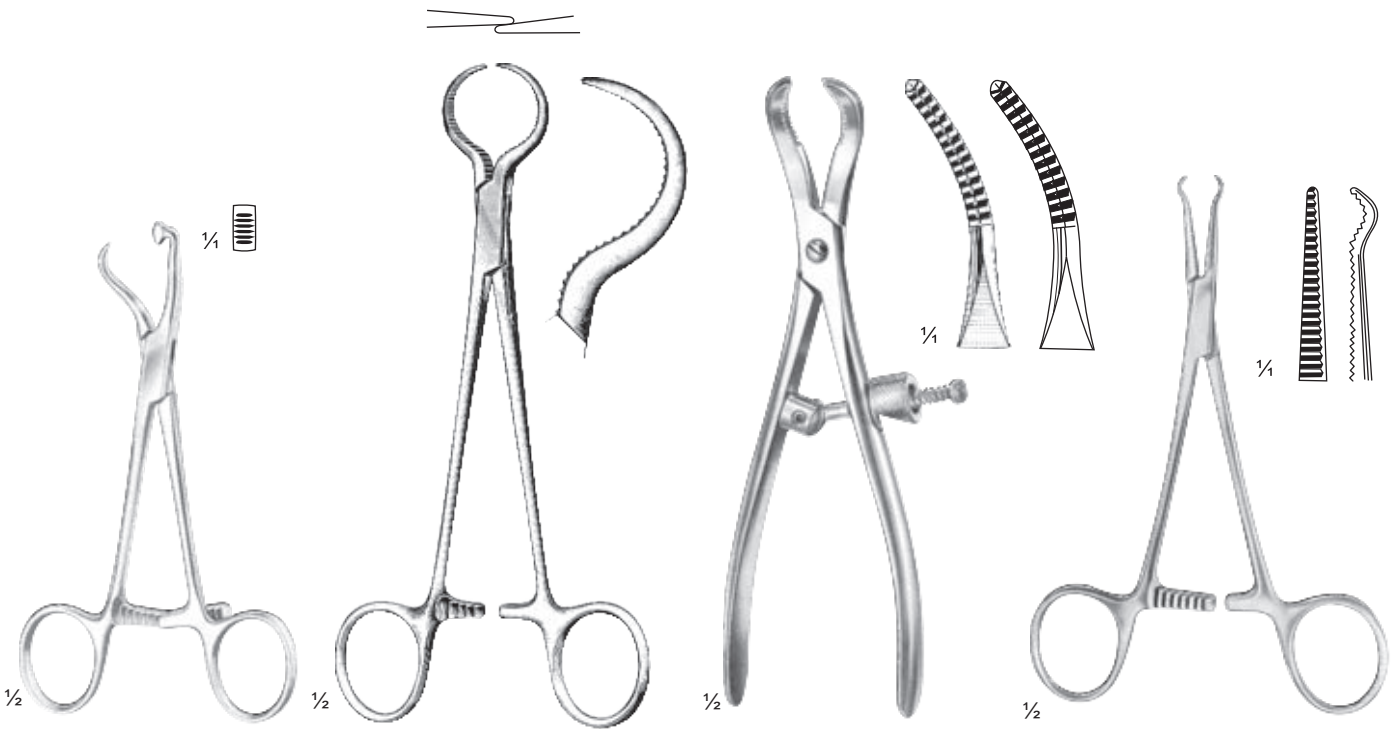

BS14-417-12
12 cm / 4 3/4"

Lewin
BS14-419-17
17.5 cm / 7"

BS14-421-16
16 cm / 6 1/4"

BS14-423-14
14 cm / 5 1/2"



Bone Holding Forceps



Bunnell-Howard
BS14-425-15
15 cm / 6"

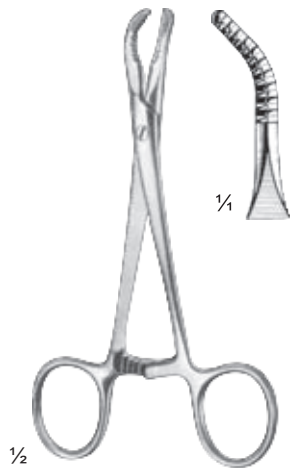

BS14-427-14
13.5 cm / 5 1/4"

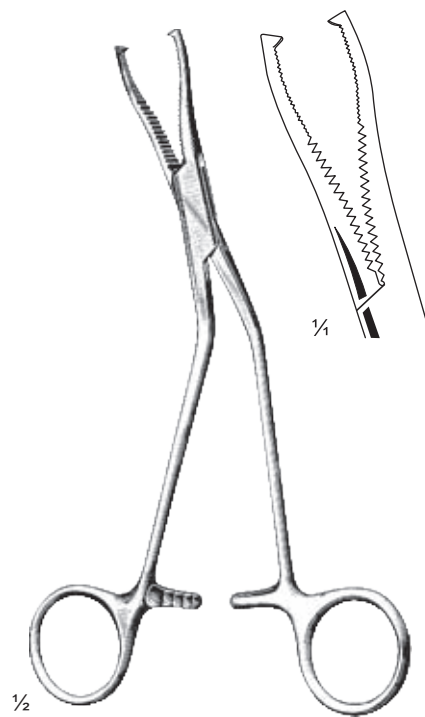

Dingmann
BS14-429-19
19 cm / 7 1/2"

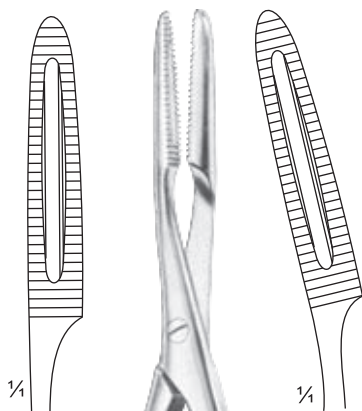

BS14-433-20
straight

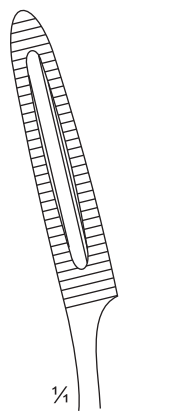

BS14-435-20
curved-on flat



20 cm / 8"

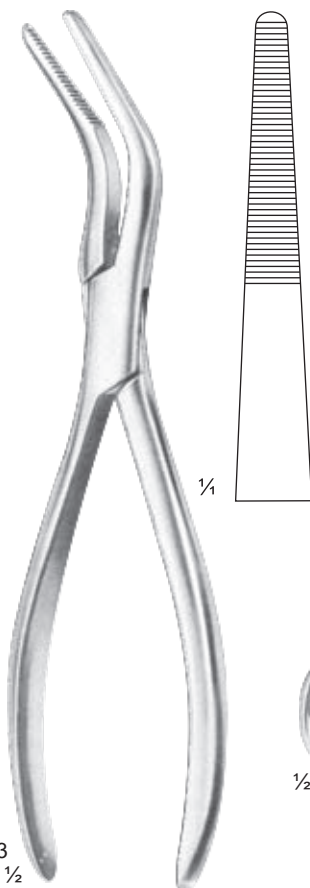

Van Buren
BS14-437-23
23 cm / 9" 1/2

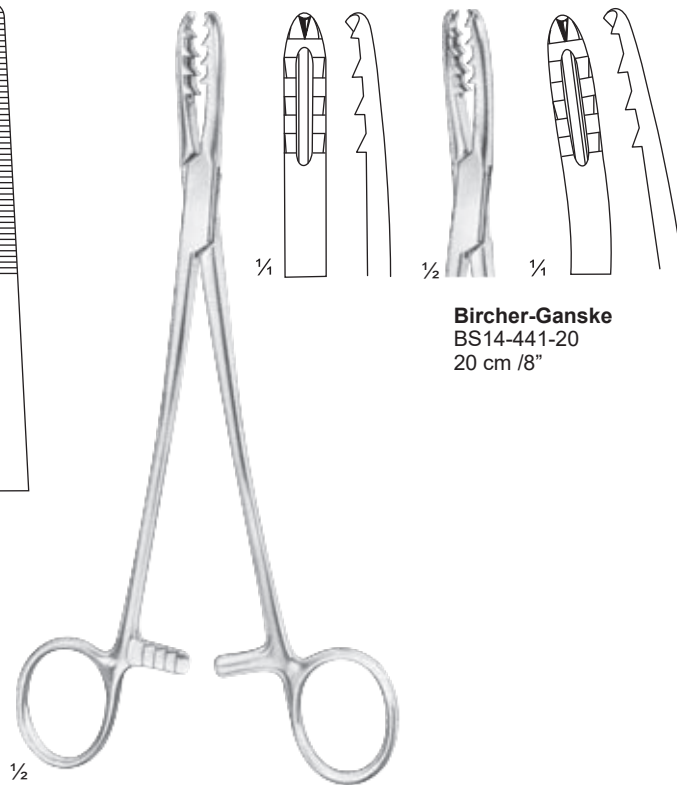

Bircher-Ganske
BS14-441-20
20 cm / 8"

Bircher-Ganske
BS14-439-20
20 cm / 8"



adjustable

cm	in.	Lambotte
22	8 ¾	BS14-443-22
27	10 ½	BS14-443-27
30	12	BS14-443-30



cm	in.	Lambotte
22	8 ¾	BS14-445-22
26	10 ¼	BS14-445-26
33	13	BS14-445-33



cm	in.	Lambotte
19	7 ½	BS14-447-19
23	9	BS14-447-23
26	10 ¼	BS14-447-26



Verburgge
BS14-449-01
17.5 cm/6 ¾"

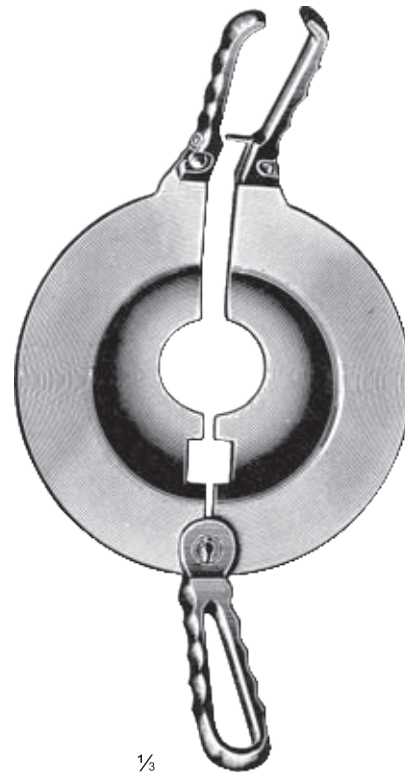

Percy
BS14-451-30
simple pattern, handles detachable



1/2

Verburgge
BS14-453-25 - 27

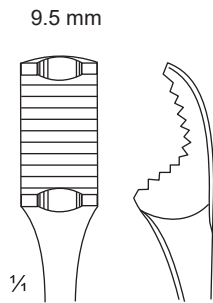

9.5 mm

Verburgge
BS14-453-25
25 cm/10"

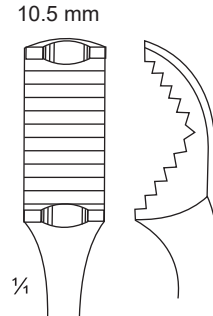

10.5 mm

Verburgge
BS14-453-26
26 cm/10 1/2"

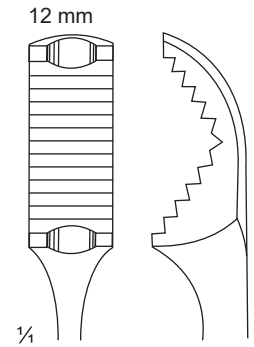

12 mm

Verburgge
BS14-453-27
27 cm/11"

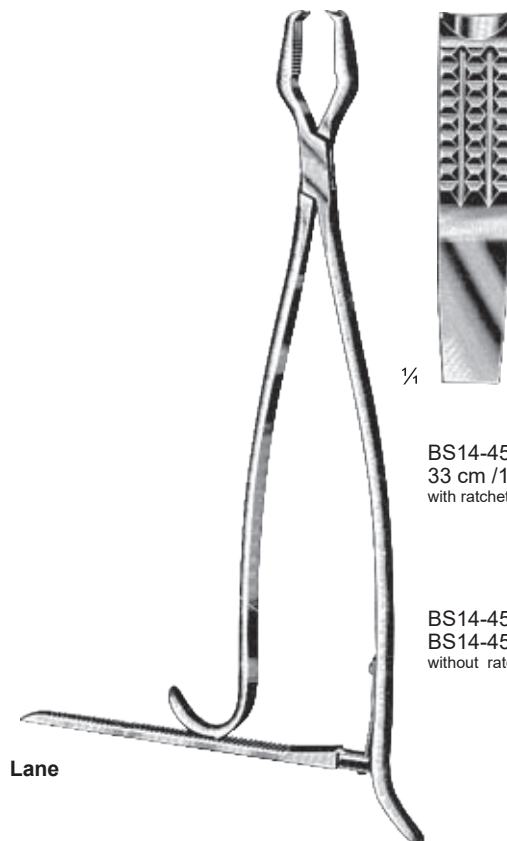

1/4

BS14-455-33
33 cm /13"
with ratchet

BS14-457-33 = 33 cm/13"
BS14-457-45 = 45 cm/17 3/4"
without ratchet

Lane

Bone Holding Forceps



Farabeuf
 BS14-459-23 = 23 cm/9"
 BS14-459-26 = 26 cm/10 ¼"

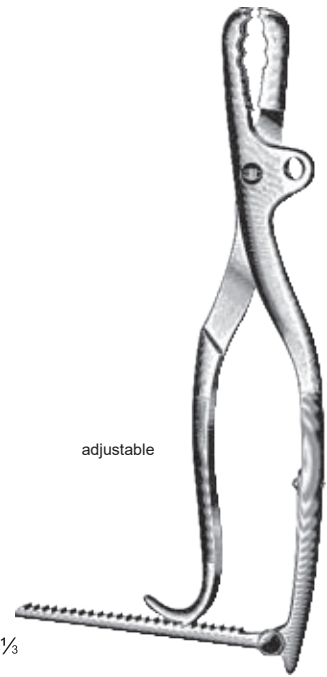

Farabeuf-Lambotte
 BS14-461-26
 26 cm/10 ¼"



Tuffier
 BS14-463-27
 27 cm/10 ½"

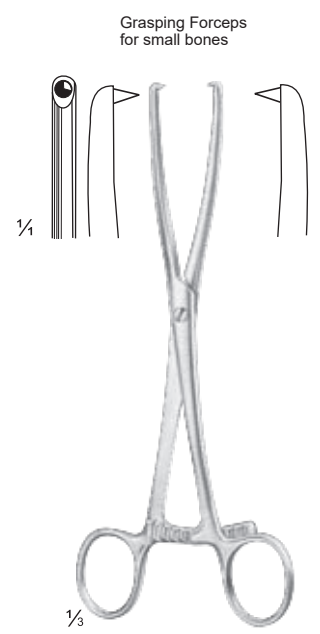

BS14-465-21
 21 cm/8 ¼"

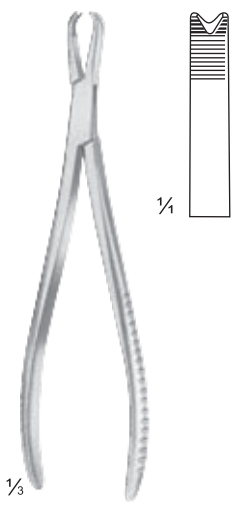

BS14-467-20
 20 cm /8"

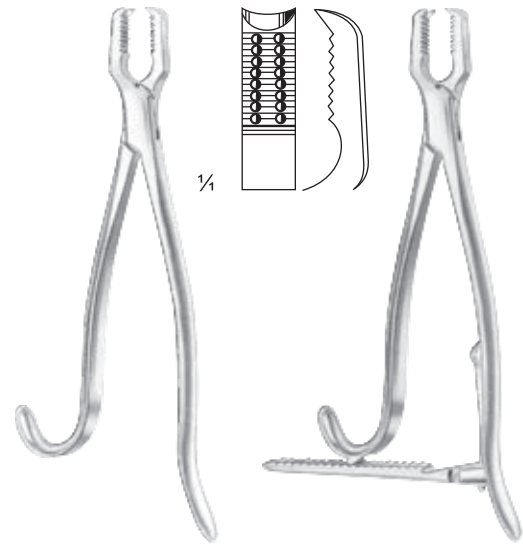

Kern

	without ratchet	cm	in.	with ratchet
BS14-469-17	17		6 ¾	BS14-471-17
BS14-469-21	21		8 ¼	BS14-471-21

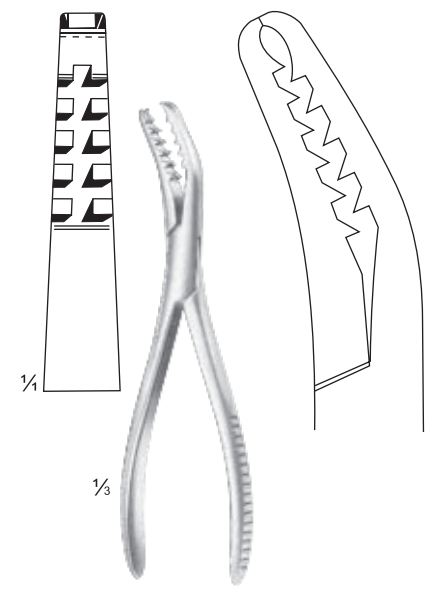

Semb
 BS14-473-19
 19 cm/7 ½"

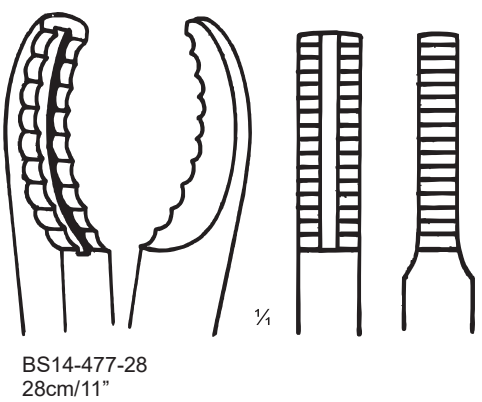
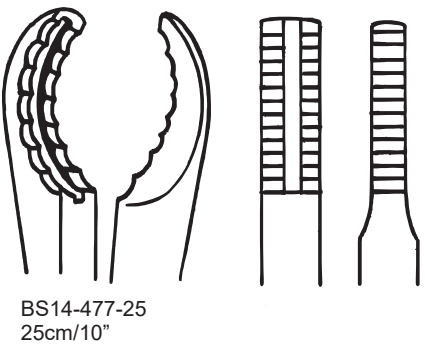
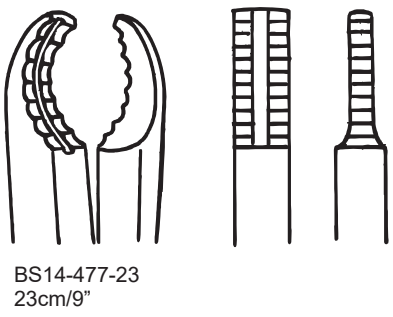
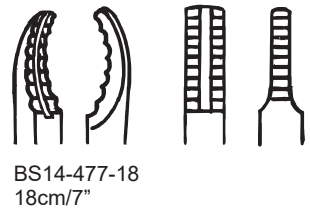
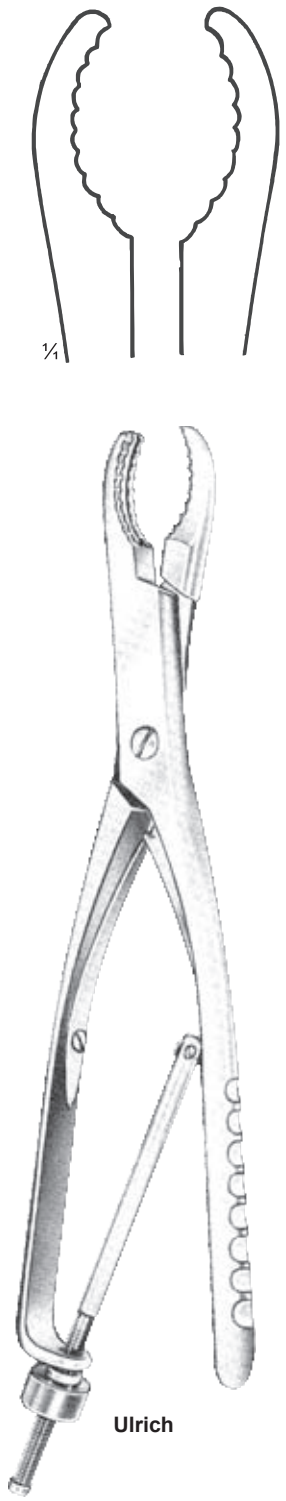
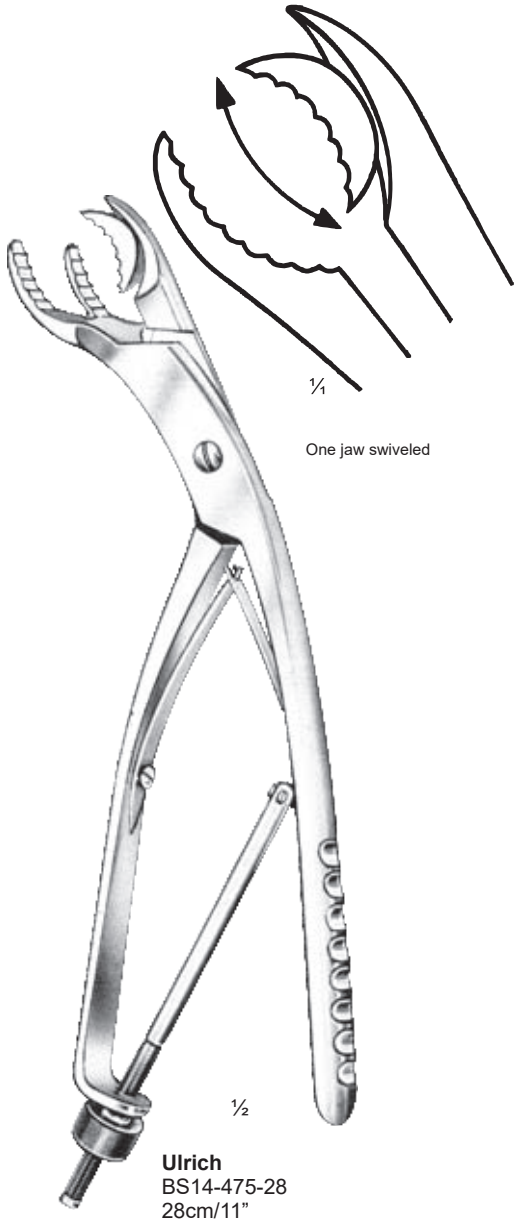

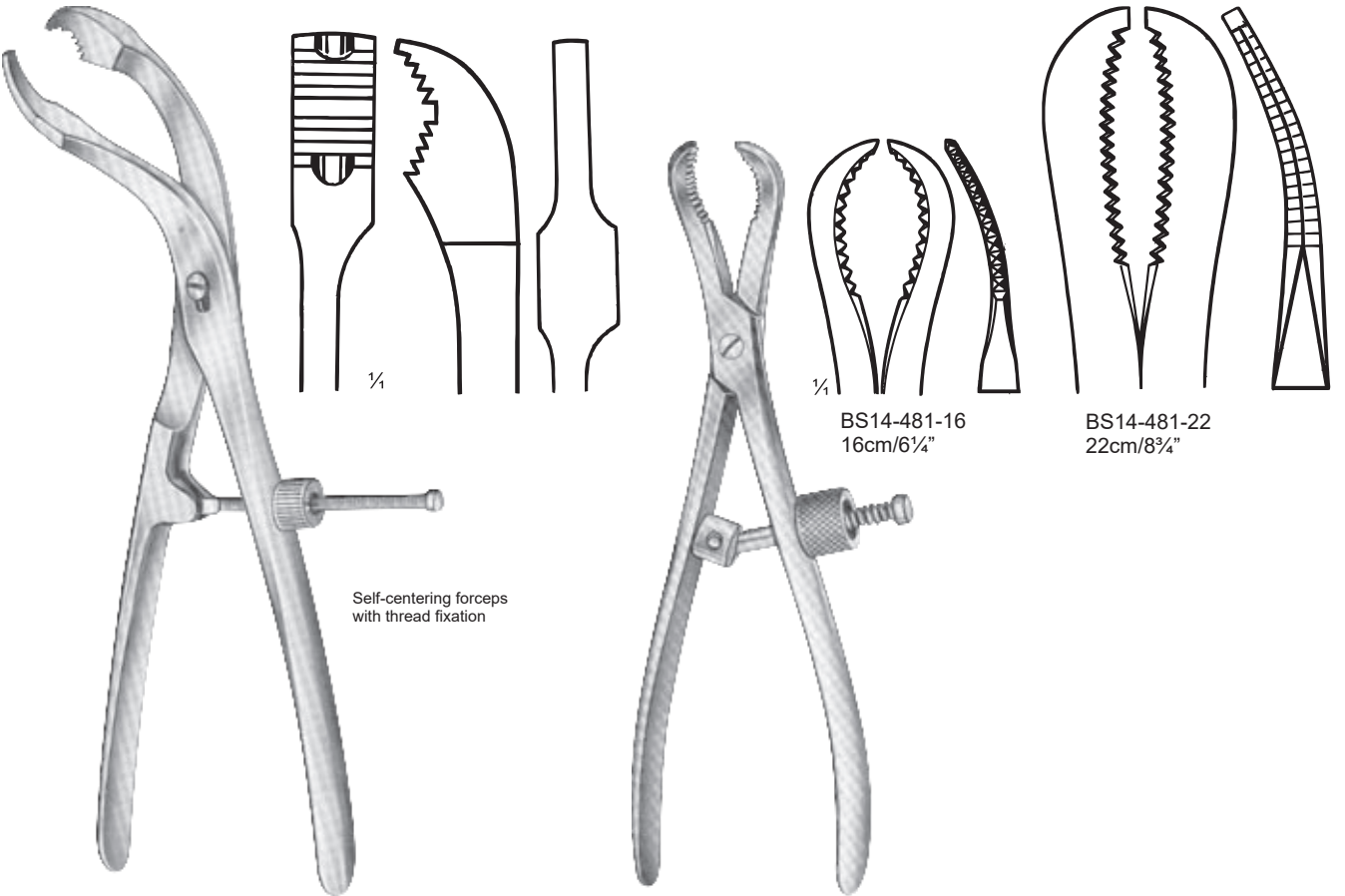
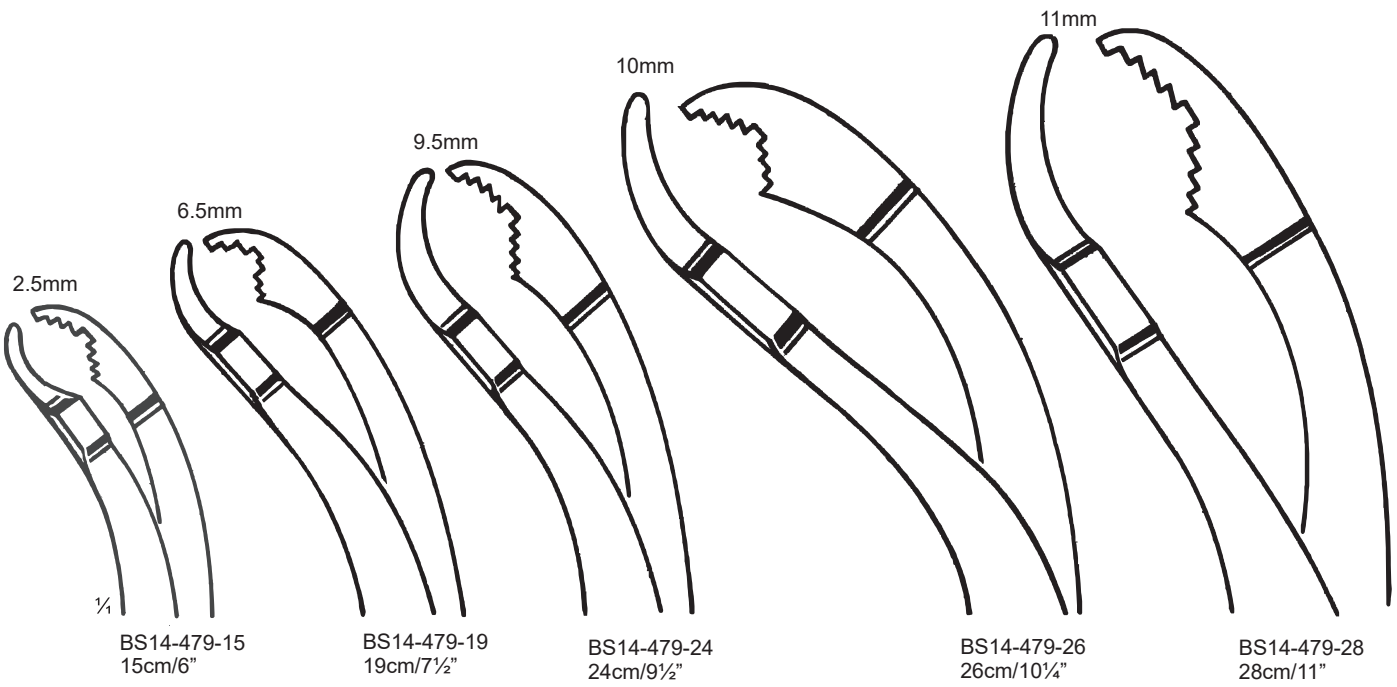

BS14-479-15 - BS14-479-28

Setter

Raspatories with Ferrozell-Handle



BS14-483-19
19cm/7 1/2"



BS14-485-18
18.5cm/7 1/4"



BS14-487-18
18.5cm/7 1/4"



BS14-489-18
18.5cm/7 1/4"



BS14-491-18
18.5cm/7 1/4"



BS14-493-19
19.5cm/7 3/4"

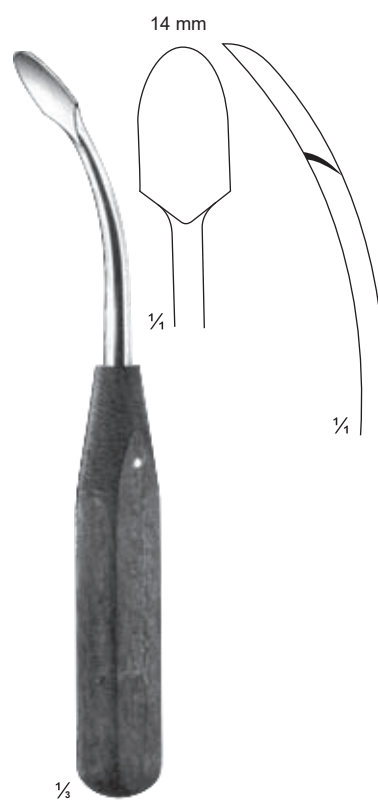

BS14-495-18
18.5cm/7 1/4"

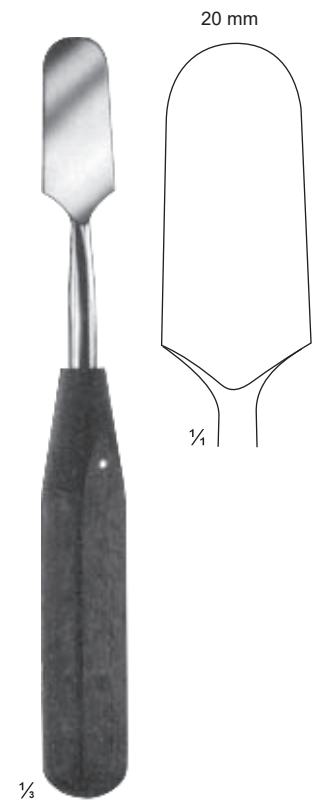

BS14-497-20
20cm/8"

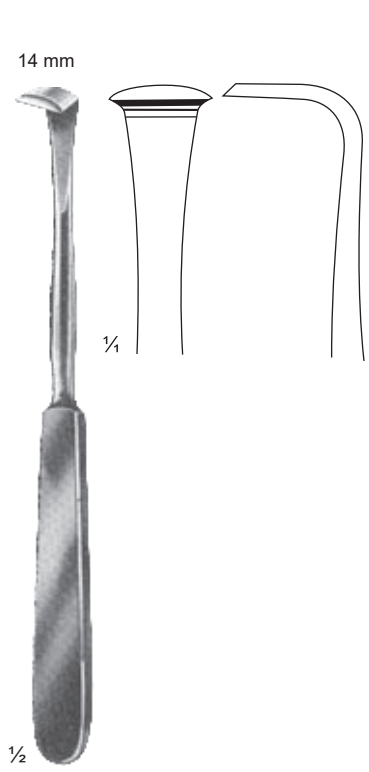

Langenbeck
BS14-499-18
18cm/7"

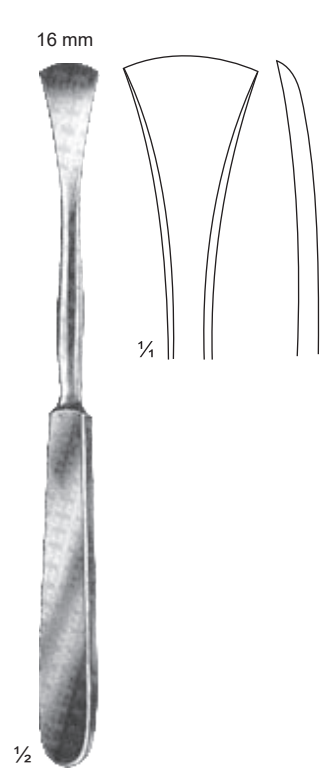

Langenbeck
BS14-501-19
19cm/7 1/2"



Cushing
BS14-503-19
19cm/7 1/2"



Lambotte
21cm/8 1/4"

05 mm	BS14-505-05
10 mm	BS14-505-10
15 mm	BS14-505-15
20 mm	BS14-505-20
25 mm	BS14-505-25

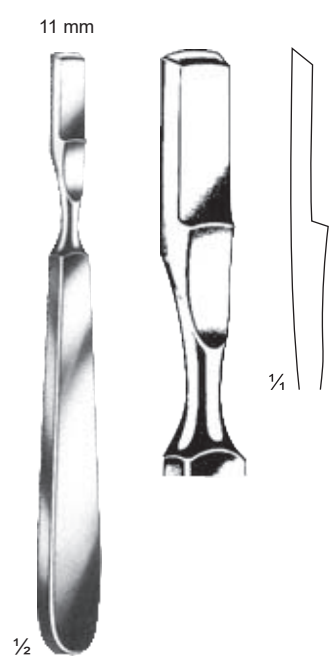

Farabeuf-Collin
BS14-507-15
15.5cm/6"

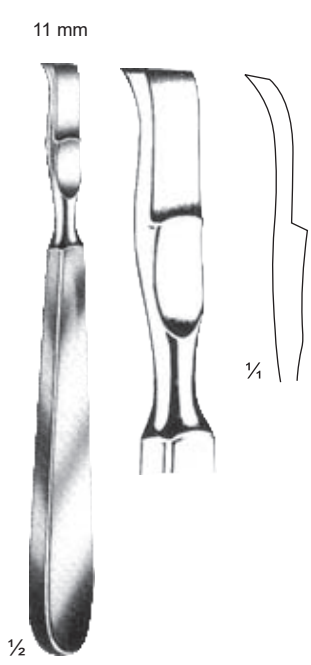

Farabeuf-Collin
BS14-509-15
15.5cm/6"

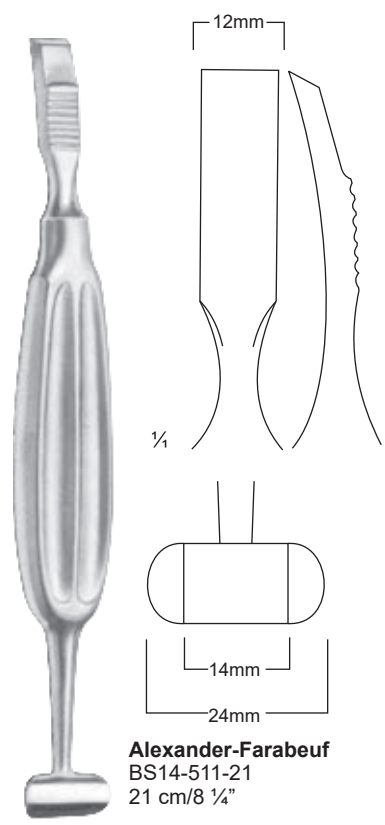

Alexander-Farabeuf
BS14-511-21
21 cm/8 1/4"



Sewall
BS14-513-20
20cm/8"

Raspatories

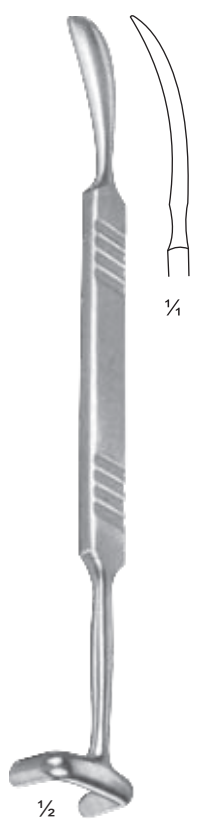

Matson
BS14-515-22
22 cm/8 3/4"



Doyen
BS14-517-17
BS14-521-17
17 cm/6 3/4"

Doyen
BS14-519-17
BS14-523-17
17 cm/6 3/4"

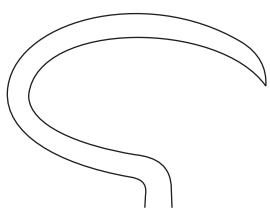

BS14-517-17
BS14-517-24

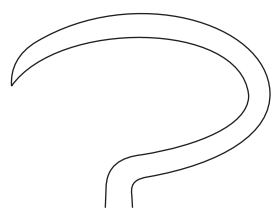

BS14-519-17
BS14-519-24

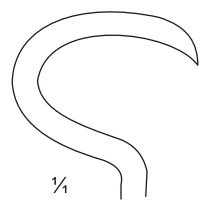

BS14-521-17

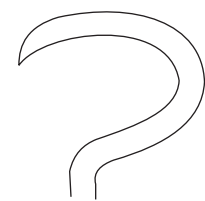

BS14-523-17



Doyen
BS14-517-24
24 cm/9 1/2"

Doyen
BS14-519-24
24 cm/9 1/2"

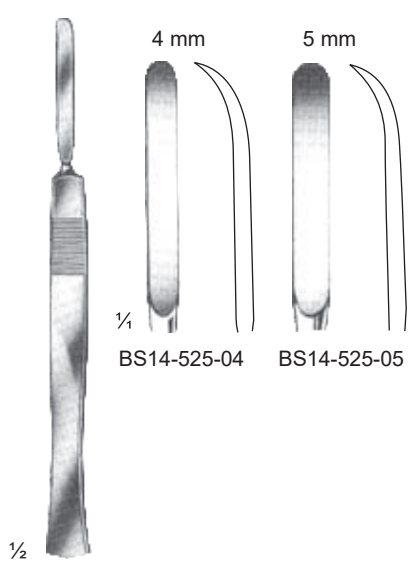

McKenty
15cm/6"

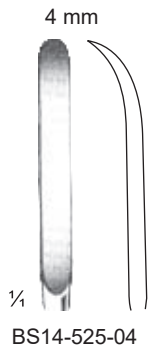

4 mm
BS14-525-04

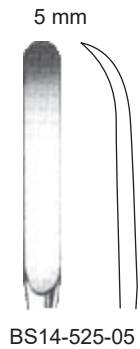

5 mm
BS14-525-05

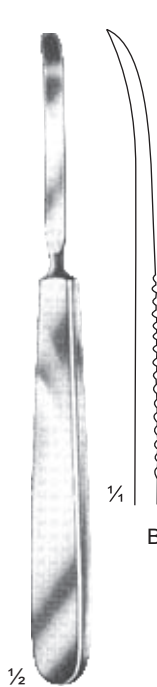

17cm/6 3/4"

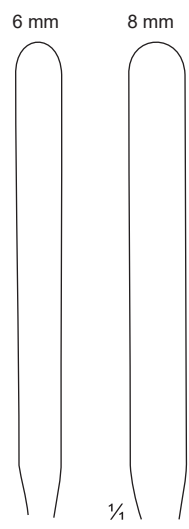

6 mm
BS14-527-06

8 mm
BS14-527-08



16cm/6 1/4"



5 mm
BS14-529-05

6 mm
BS14-529-06

7 mm
BS14-529-07

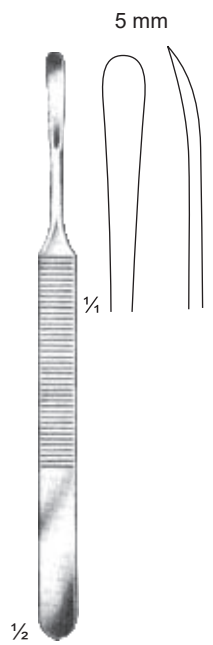

Konig
BS14-531-05
15.5cm/6"





Fomon
BS14-533-17
17cm/6 3/4"



Joseph
BS14-535-16
16cm/6 1/4"



Joseph
BS14-537-16
16cm/6 1/4"

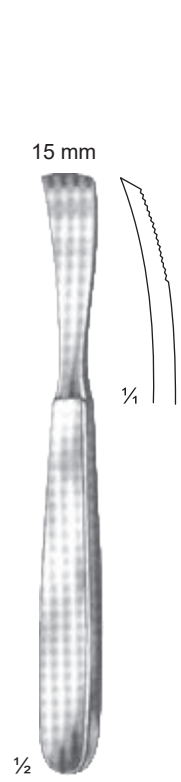

Jansen
BS14-539-16
16.5cm/6 1/2"

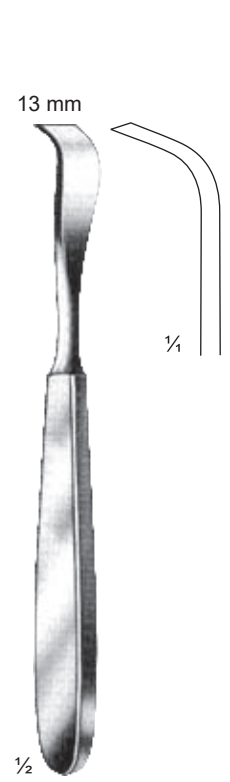

Schneider
BS14-541-17
17.5cm/7"





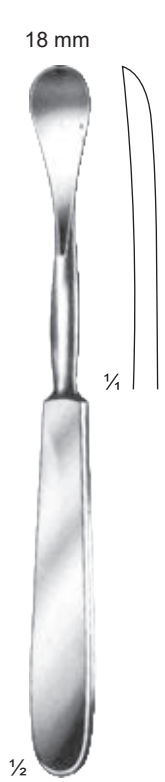



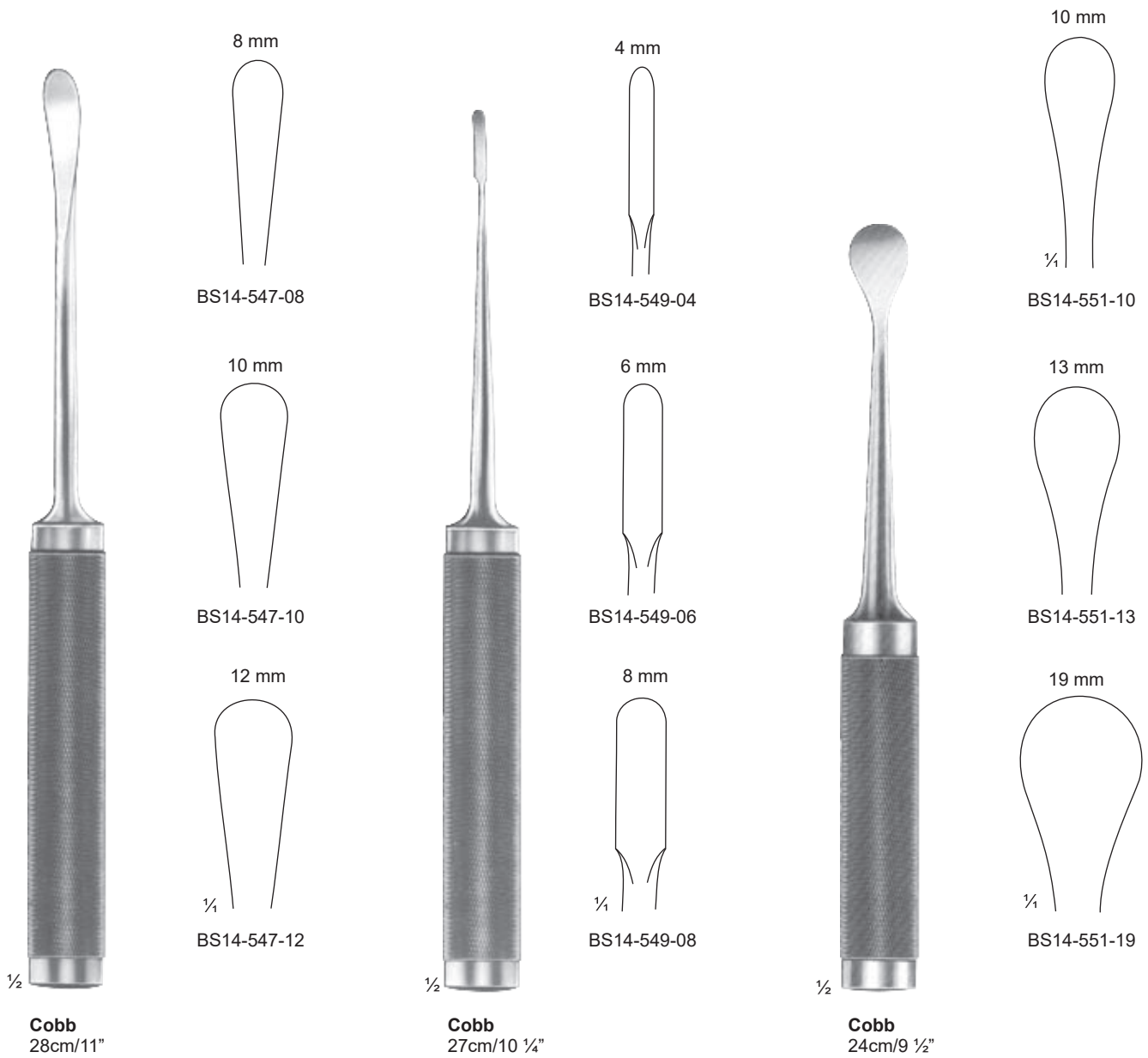



Schneider-Sauerbruch
BS14-543-19
19cm/7 1/2"

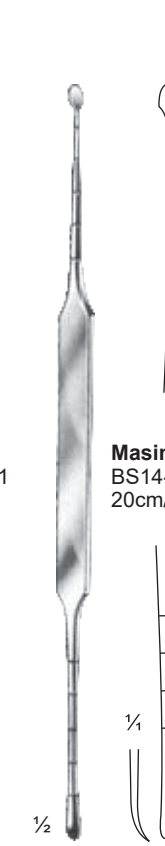

Sedillot
BS14-545-18
18cm/7"

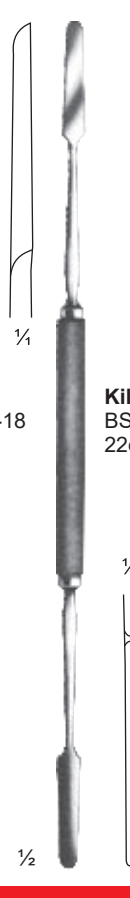

Septum Elevators and Raspatories

 <p>Carter BS14-553-21 21cm/8 1/4"</p>	 <p>BS14-555-18 18cm/7"</p>	 <p>Joseph-Masing BS14-557-22 22cm/8 3/4"</p>	 <p>Howarth BS14-559-21 21cm/8 1/4"</p>	 <p>Masing BS14-561-20 20cm/8"</p>	 <p>Cottle BS14-563-21 21cm/8 1/4"</p>
 <p>Cottle BS14-565-23 23cm/9"</p>	 <p>McKenty BS14-567-22 22cm/8 3/4"</p>	 <p>Killian BS14-569-18 15cm/7"</p>	 <p>Killian BS14-569-22 22cm/8 3/4"</p>	 <p>Pierce BS14-571-21 21cm/8 1/4"</p>	 <p>Pennington BS14-573-21 21cm/8 1/4"</p> <p>Roger BS14-575-19 19cm/7 1/2"</p>

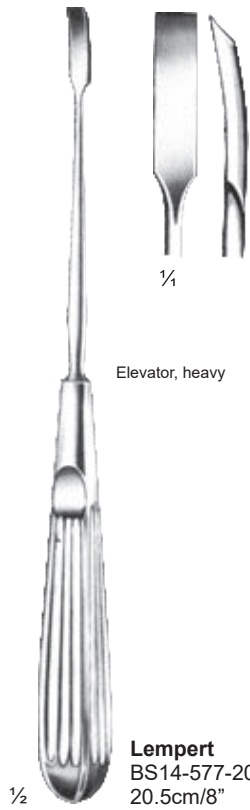

Elevator, heavy

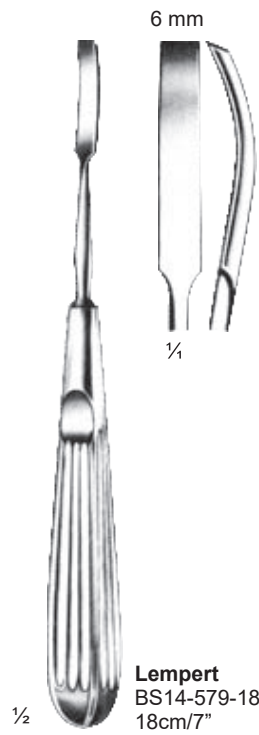

Septum Elevators

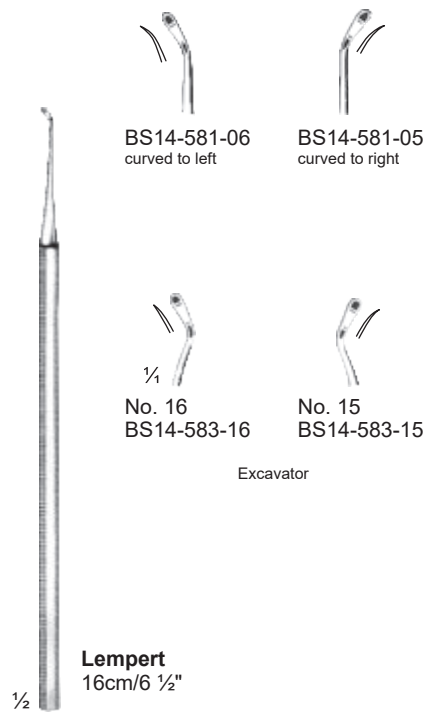

Excavator

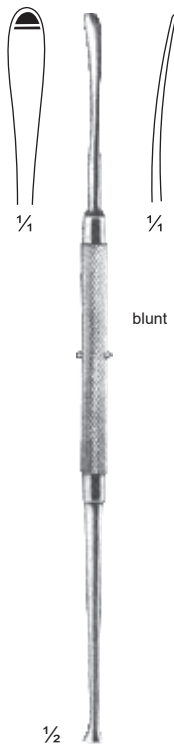

blunt

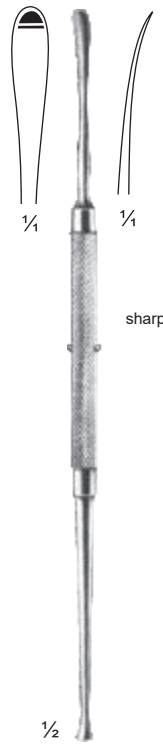

sharp



blunt

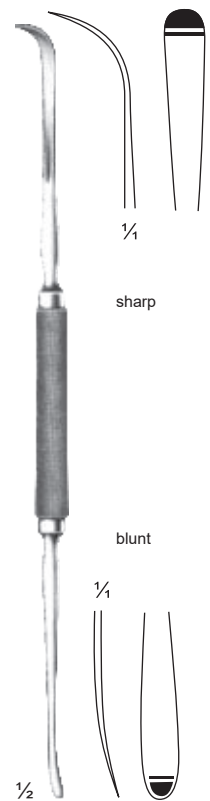

blunt

sharp

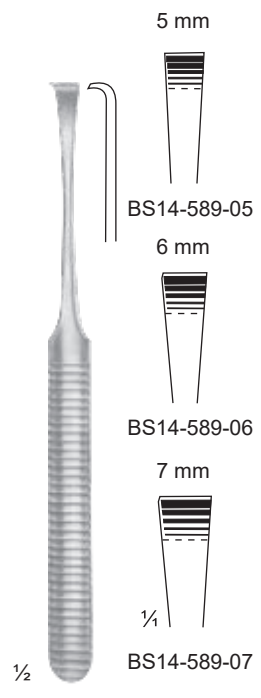

16 cm / 6 1/4"

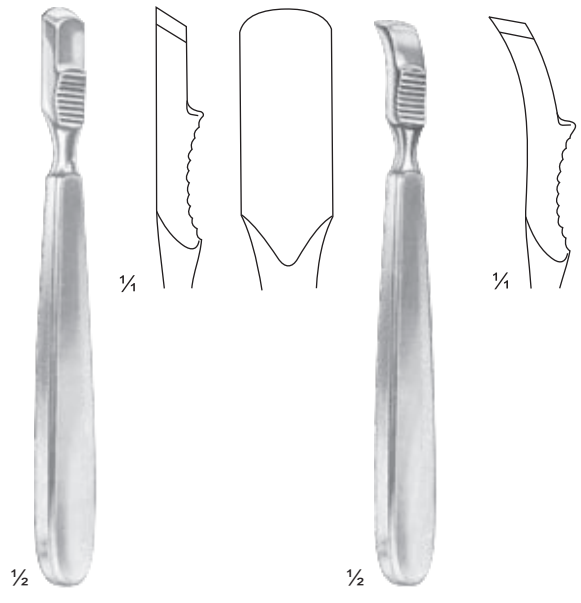

Farabeuf
DC14-591-15
15 cm / 6"

Farabeuf
DC14-593-15
15 cm / 6"

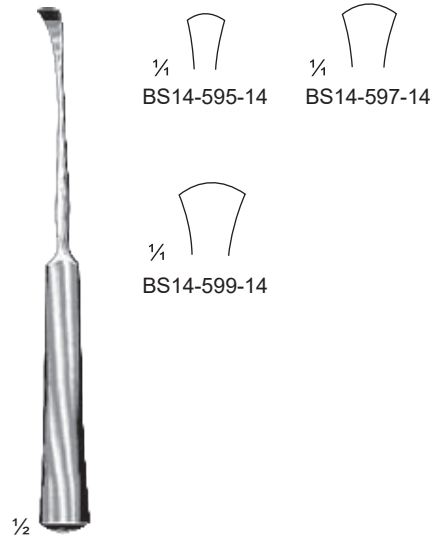

Hylin
14.5 cm / 5 1/2"

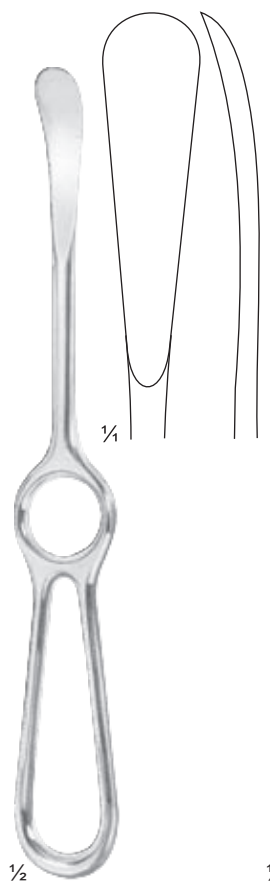

Sedillot
DC14-601-21
21 cm / 8 1/4"

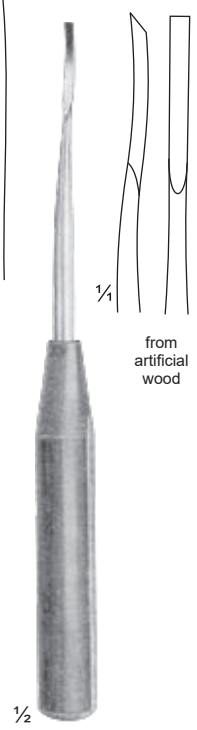

BS14-603-18
18 cm / 7"



BS14-605-18
18 cm / 7"

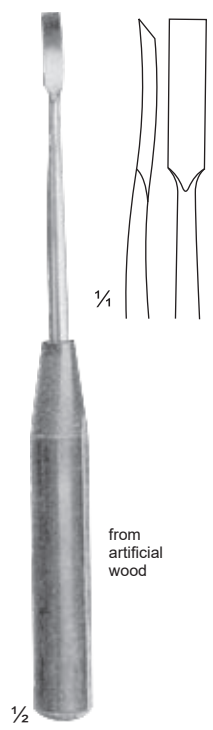

BS14-607-18
18 cm / 7"

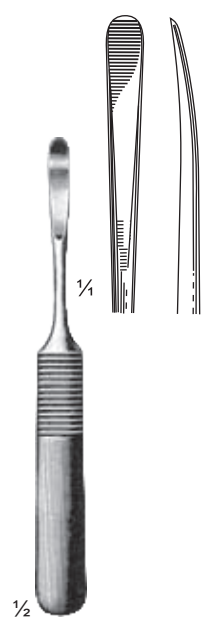

Williger
BS14-609-13
13 cm / 5"

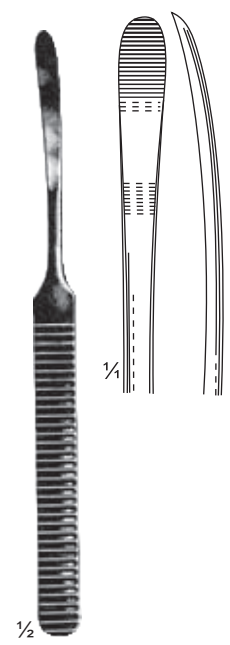

Williger
BS14-611-16
16 cm / 6 1/4"



Costal Periosteotomes, Raspatories, Elevators

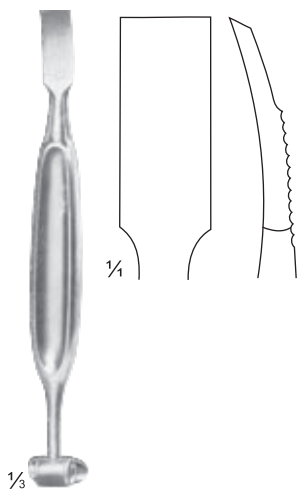

Alexander
BS14-613-20
20 cm/8"



Matson
BS14-615-22
22 cm/8 3/4"



Overholt
BS14-617-29
29.5 cm/11 1/2"



Overholt
BS14-619-29
29.5 cm/11 1/2"



Overholt
BS14-621-28
28.5 cm/11"



Davidson-Alexander
BS14-623-29
29 cm/11 1/2"



Semb



BS14-625-01
17.5 cm/7"



BS14-625-02
21 cm/8 1/4"



BS14-625-03
17.5 cm/7"



BS14-625-04
21 cm/8 1/4"



BS14-625-05
20.5 cm/8"



BS14-625-06
20.5 cm/8"



BS14-625-07
22.5 cm/9"

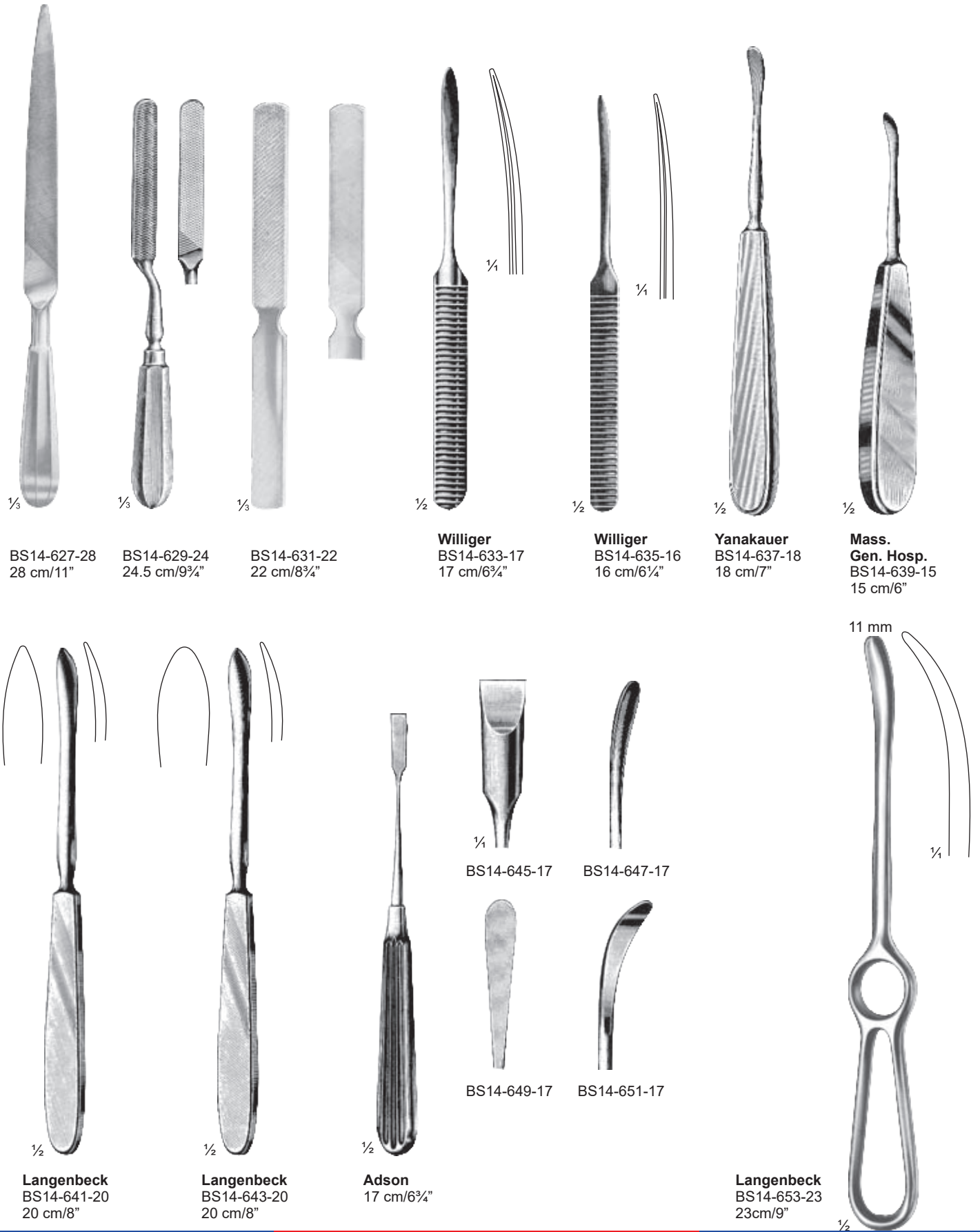

$\frac{1}{3}$ BS14-627-28 28 cm/11"
 $\frac{1}{3}$ BS14-629-24 24.5 cm/9 $\frac{3}{4}$ "
 $\frac{1}{3}$ BS14-631-22 22 cm/8 $\frac{3}{4}$ "
 $\frac{1}{2}$ Williger BS14-633-17 17 cm/6 $\frac{3}{4}$ "
 $\frac{1}{2}$ Williger BS14-635-16 16 cm/6 $\frac{1}{4}$ "
 $\frac{1}{2}$ Yanakauer BS14-637-18 18 cm/7"
 $\frac{1}{2}$ Mass. Gen. Hosp. BS14-639-15 15 cm/6"

$\frac{1}{2}$ Langenbeck BS14-641-20 20 cm/8"
 $\frac{1}{2}$ Langenbeck BS14-643-20 20 cm/8"
 $\frac{1}{2}$ Adson 17 cm/6 $\frac{3}{4}$ "
 $\frac{1}{4}$ BS14-645-17
 $\frac{1}{4}$ BS14-647-17
 $\frac{1}{4}$ BS14-649-17
 $\frac{1}{4}$ BS14-651-17
 11 mm
 $\frac{1}{2}$ Langenbeck BS14-653-23 23cm/9"

Elevators



Killian
BS14-655-17
17cm/6 3/4"



Killian
BS14-657-17
17cm/6 3/4"



Killian
BS14-659-18
17cm/6 3/4"

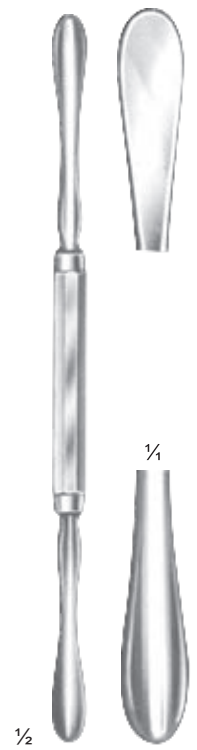

Ballenger-Hajek
BS14-661-19 = 17cm/7 1/2"
BS14-661-22 = 22cm/8 3/4"

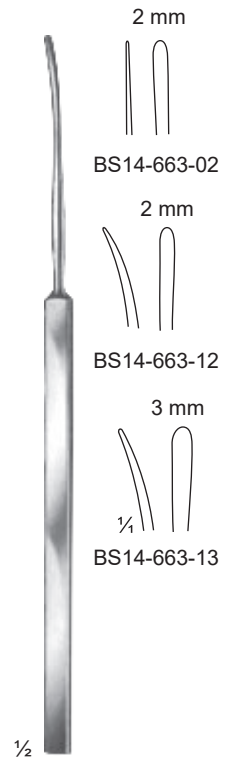

Lempert
19cm/7 1/2"

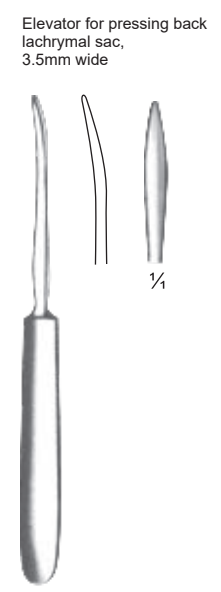

Lueneburg
BS14-665-35
12cm/4 3/4"



Sebileau
BS14-667-17
17cm/6 3/4"



Quervain
BS14-669-20
20cm/8"



Langenbeck
BS14-671-20
20cm/8"



Langenbeck
BS14-673-20
20cm/8"

Elevators



Alderdyce
BS14-675-21
21 cm/8¼"



McDonald
BS14-677-19
19 cm/7½"



Watson-Cheyne
BS14-679-17
17.5 cm/7"

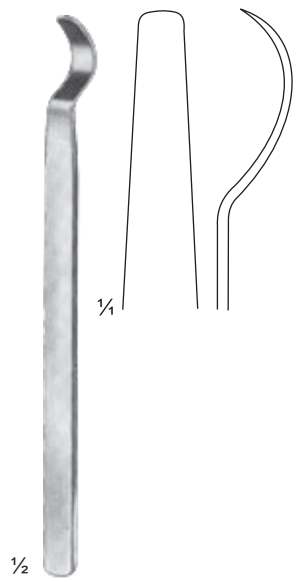

BS14-681-06
14 cm/5½"



Mini-Hohmann
16 cm/6¼"

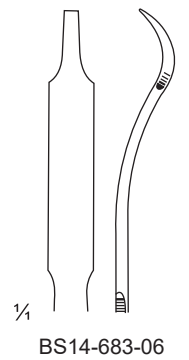

BS14-683-06

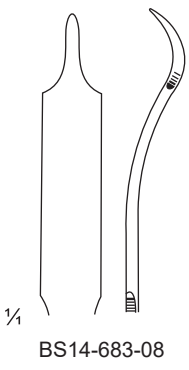

BS14-683-08



BS14-685-17
17.5 cm/6¾"



BS14-687-16
16 cm/6¼"



Key
19 cm/7½"

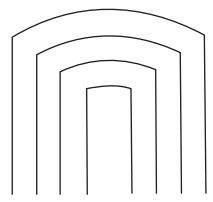

width	mm
6	BS14-689-06
12	BS14-689-12
19	BS14-689-19
25	BS14-689-25



BS14-691-16
16 cm/6¼"



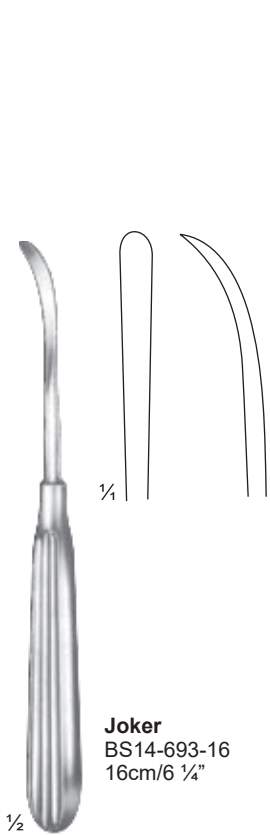

Joker
BS14-693-16
16cm/6 1/4"

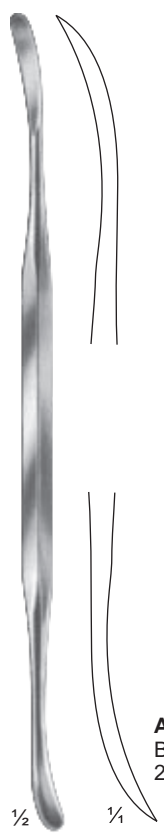

Alderdyce
BS14-695-21
21cm/8 1/4"



McDonald
BS14-697-19
19cm/7 1/2"



Freer
BS14-699-18
18.5cm/7 1/4"



BS14-701-17
17.5cm/6 3/4"



BS14-703-16
16cm/6 1/4"



Halle
BS14-705-16
16cm/6 1/4"

Dura Separators, Zygoma Elevators

Zygoma Elevatos



Dingman
BS14-709-21
21cm/8 1/4"

1/2



Gillies
BS14-711-21
21cm/8 1/4"

1/2



Gillies
BS14-713-21
21cm/8 1/4"

1/2



Frazier
BS14-715-01
15cm/6"

1/2



Hoehn
BS14-715-45
15cm/6"

1/2



Hoehn
BS14-715-90
15cm/6"

1/2

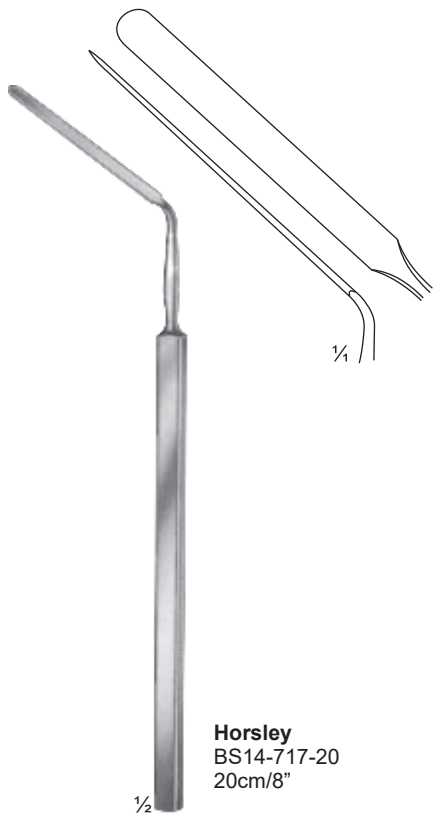

Horsley
BS14-717-20
20cm/8"

1/2



Sachs
BS14-719-21
21cm/8 1/4"

1/2



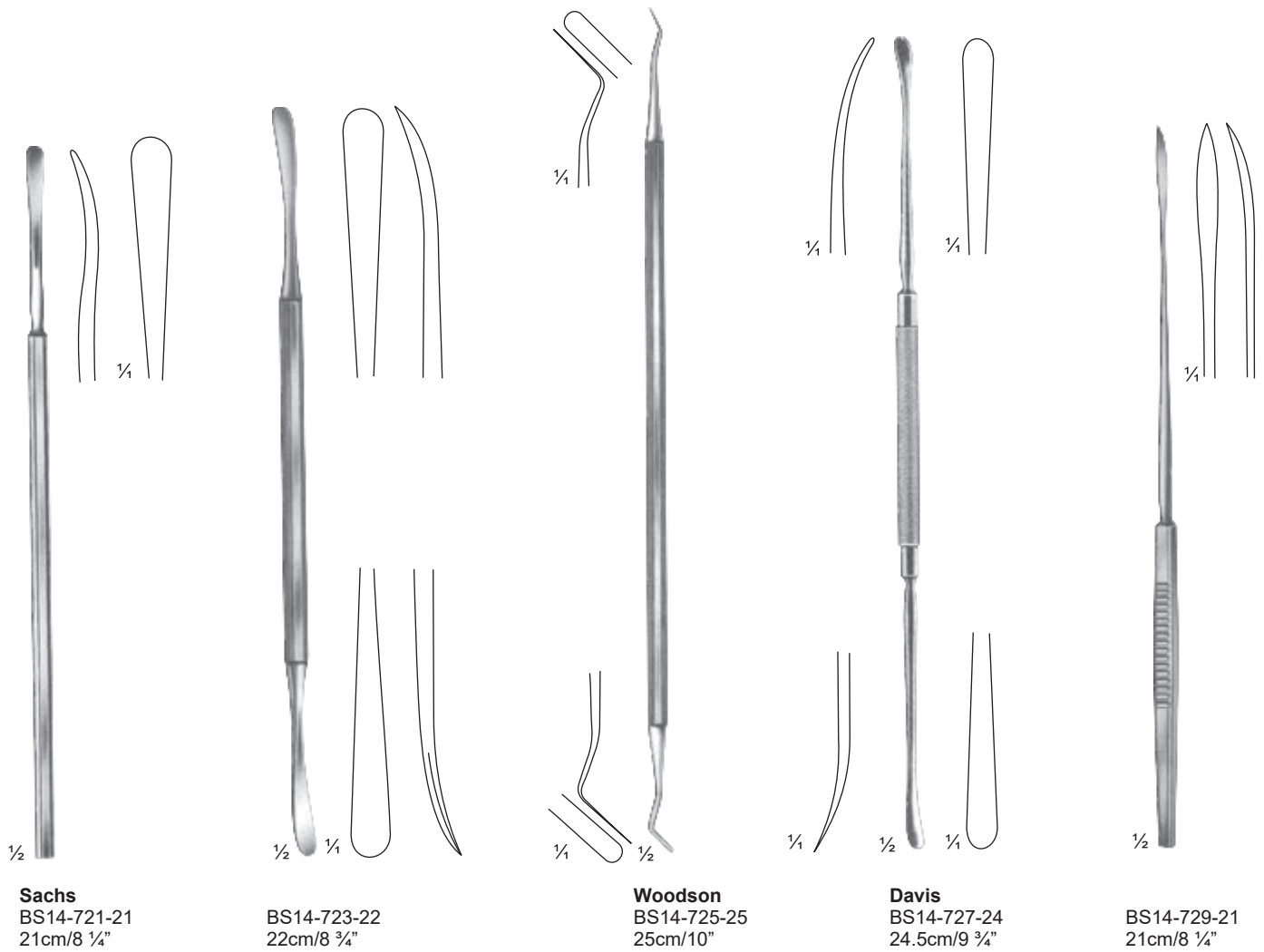

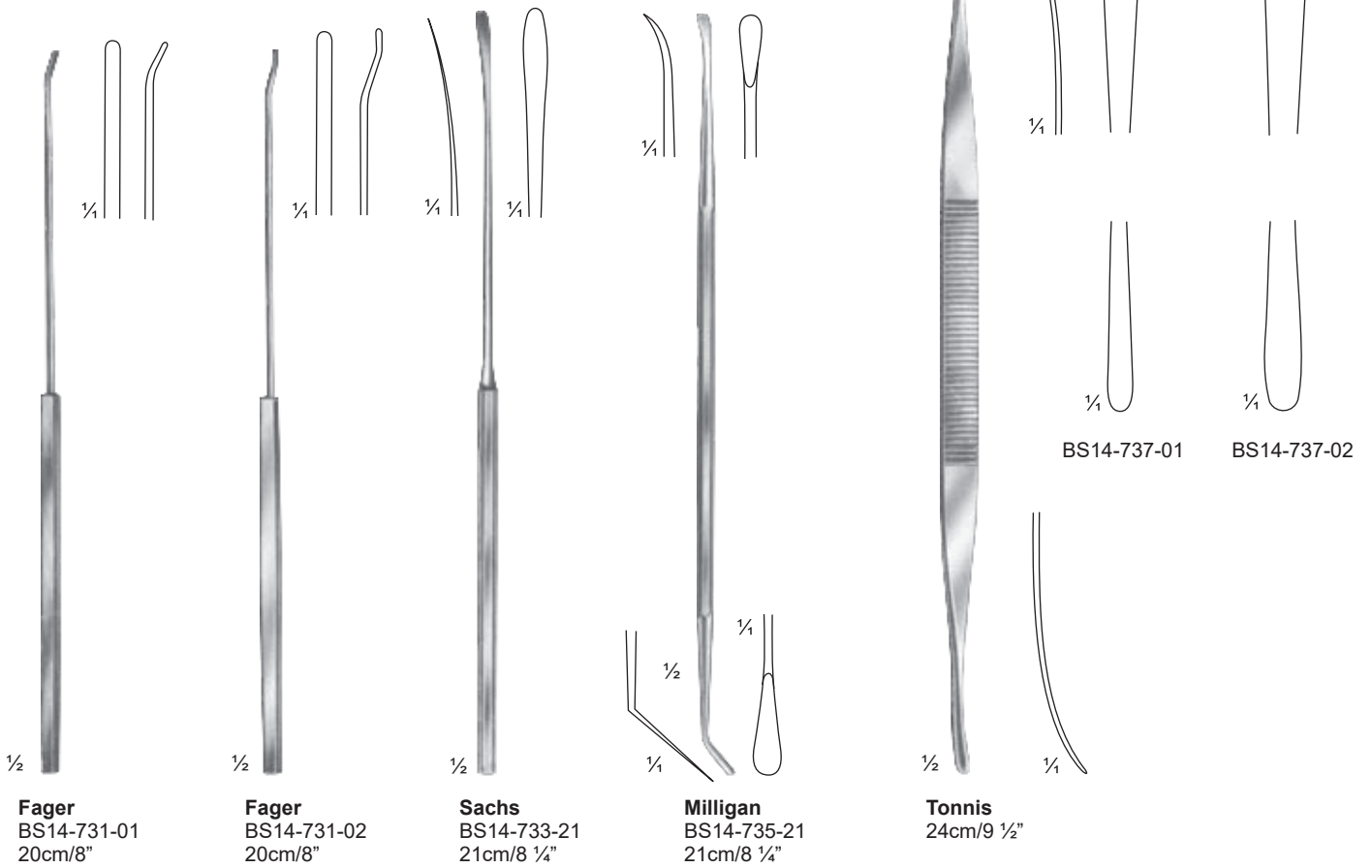

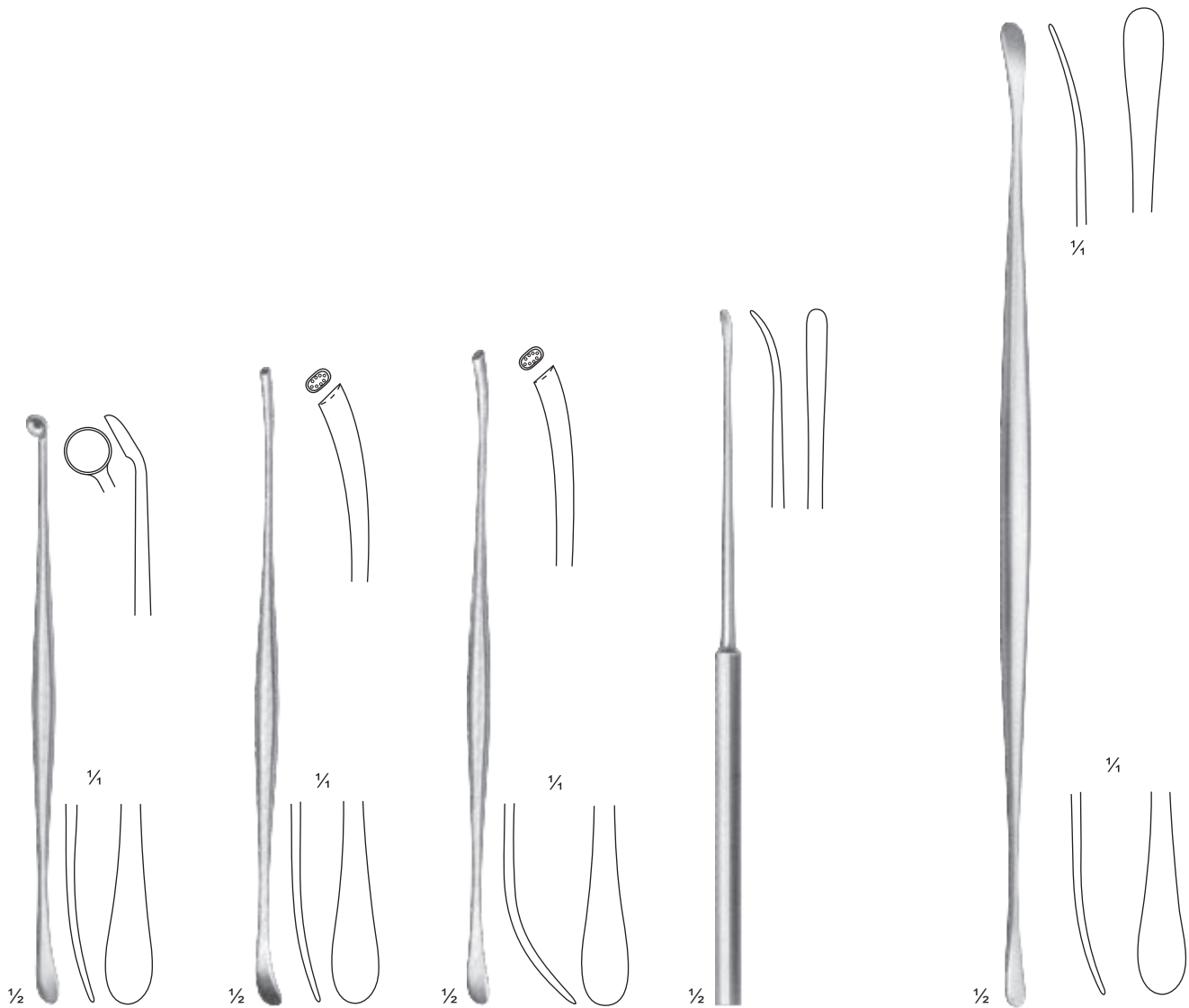

Penfield
Fig. 1
BS14-739-01
17.5cm/7"

Penfield
Fig. 2
BS14-739-02
19.5cm/7 3/4"

Penfield
Fig. 3
BS14-739-03
19.5cm/7 3/4"

Penfield
Fig. 4
BS14-739-04
20cm/8"

Penfield
Fig. 5
BS14-739-05
29cm/11"

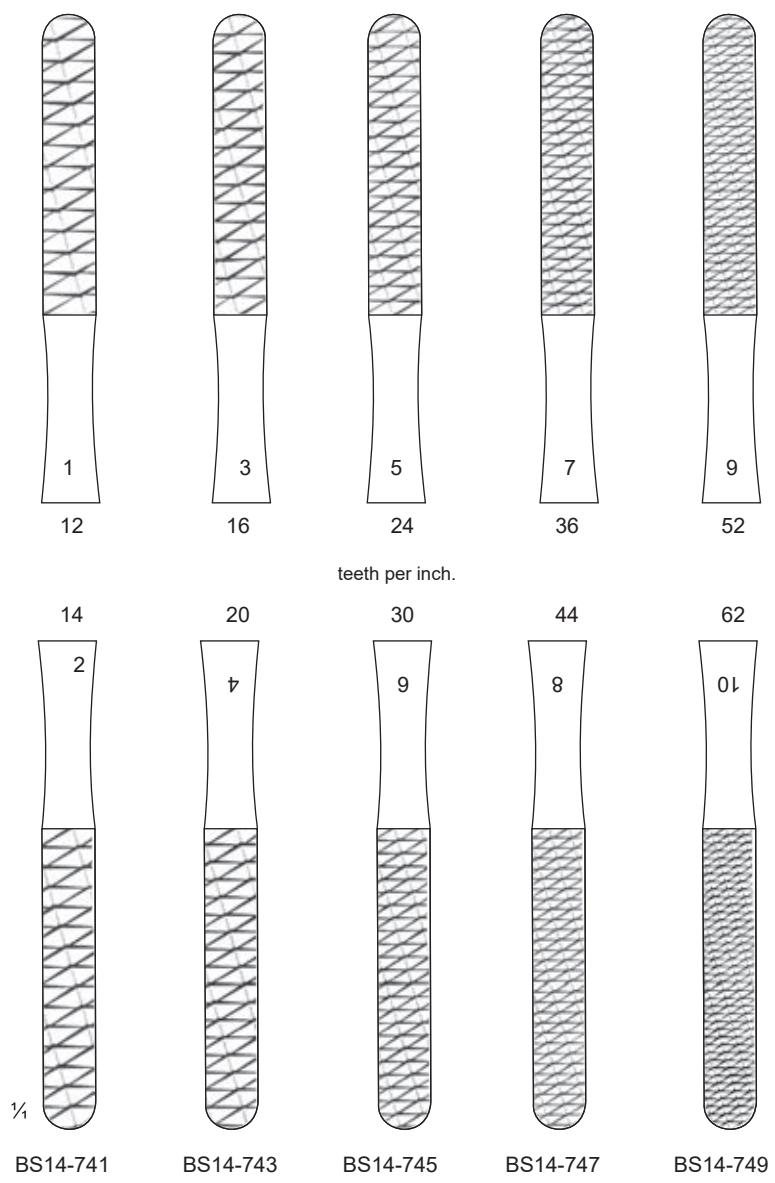
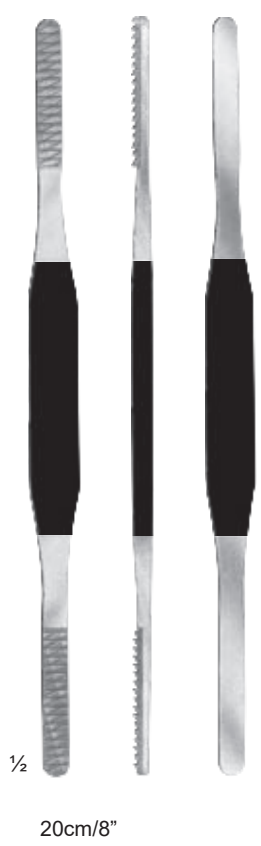

Rasps, Type Maltz, Miller

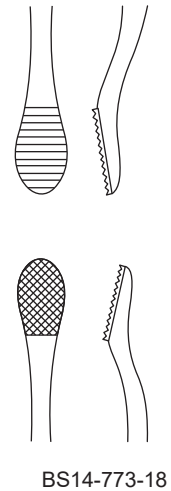
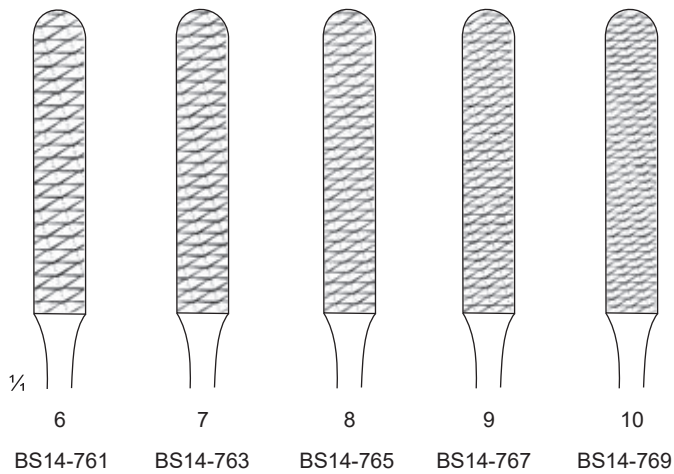
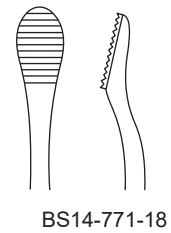
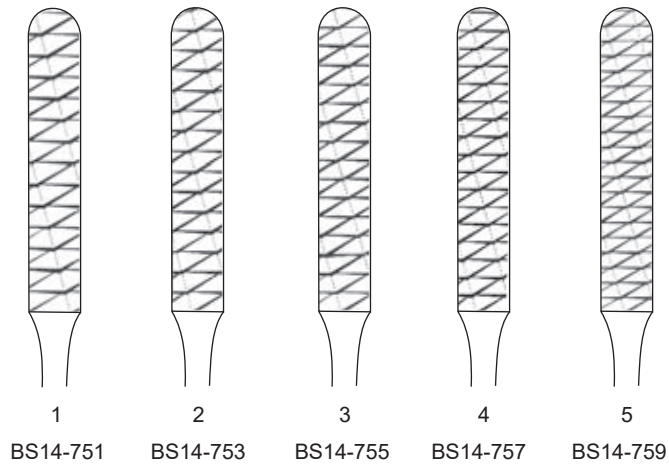

Bone Levers

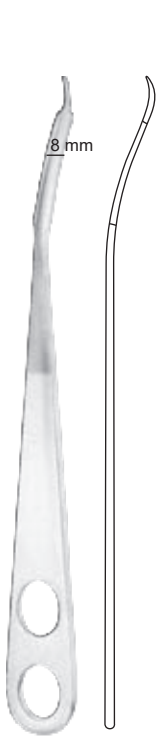

Hohmann
BS14-775-08
8 mm

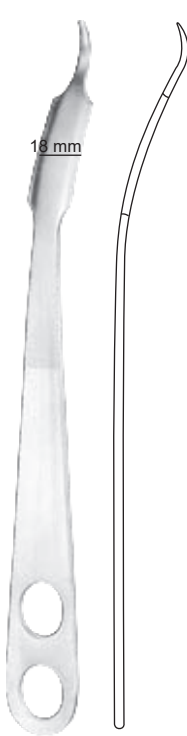

Hohmann
BS14-775-18
18 mm

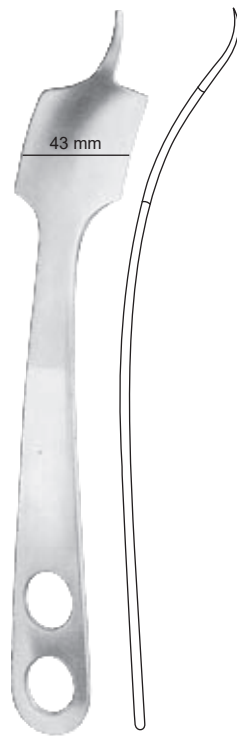

Hohmann
BS14-775-43
43 mm



Hohmann
BS14-775-70
70 mm



Hohmann
BS14-777-43
43 mm

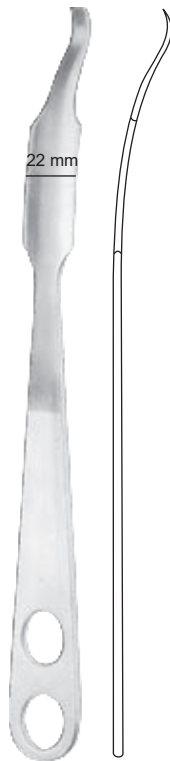

Hohmann
BS14-779-22
22 mm



Hohmann
BS14-779-35
33 mm



BS14-781-24
24 mm

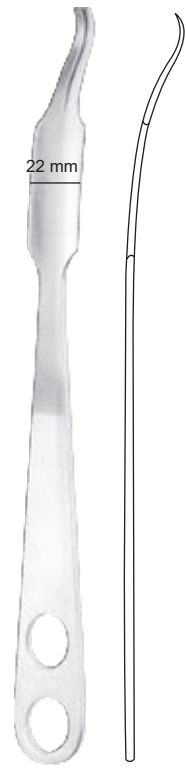

Lange-Hohmann
BS14-783-22
22 mm

Bone Levers

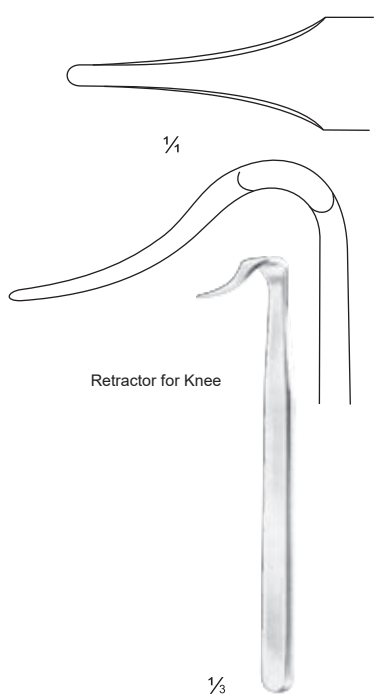

Retractor for Knee

Blount
BS14-785-17
17.5 cm/7"

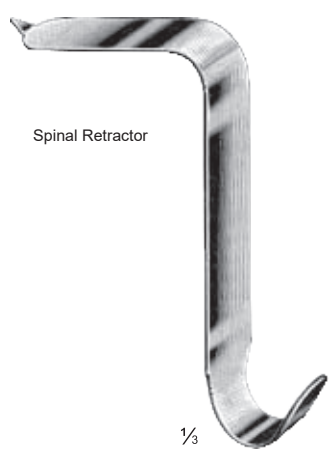

Spinal Retractor

Taylor
BS14-787-16 16.5 cm/6½"
75 x 30 mm BS14-789-16 16.5 cm/6½"
100 x 30 mm



Blount
BS14-791-26
26 cm/10¼"



Blount
BS14-793-26
26 cm/10¼"



Lane
BS14-795-34
34 cm/13½"



Lange-Hohmann
BS14-797-27 27 cm/10½" BS14-797-29 29 cm/11½"



Lange-Hohmann
BS14-799-27 27 cm/10½" BS14-799-29 29 cm/11½"



Bennett
BS14-801-24
24 cm/9½"

Meniscotomy Knives

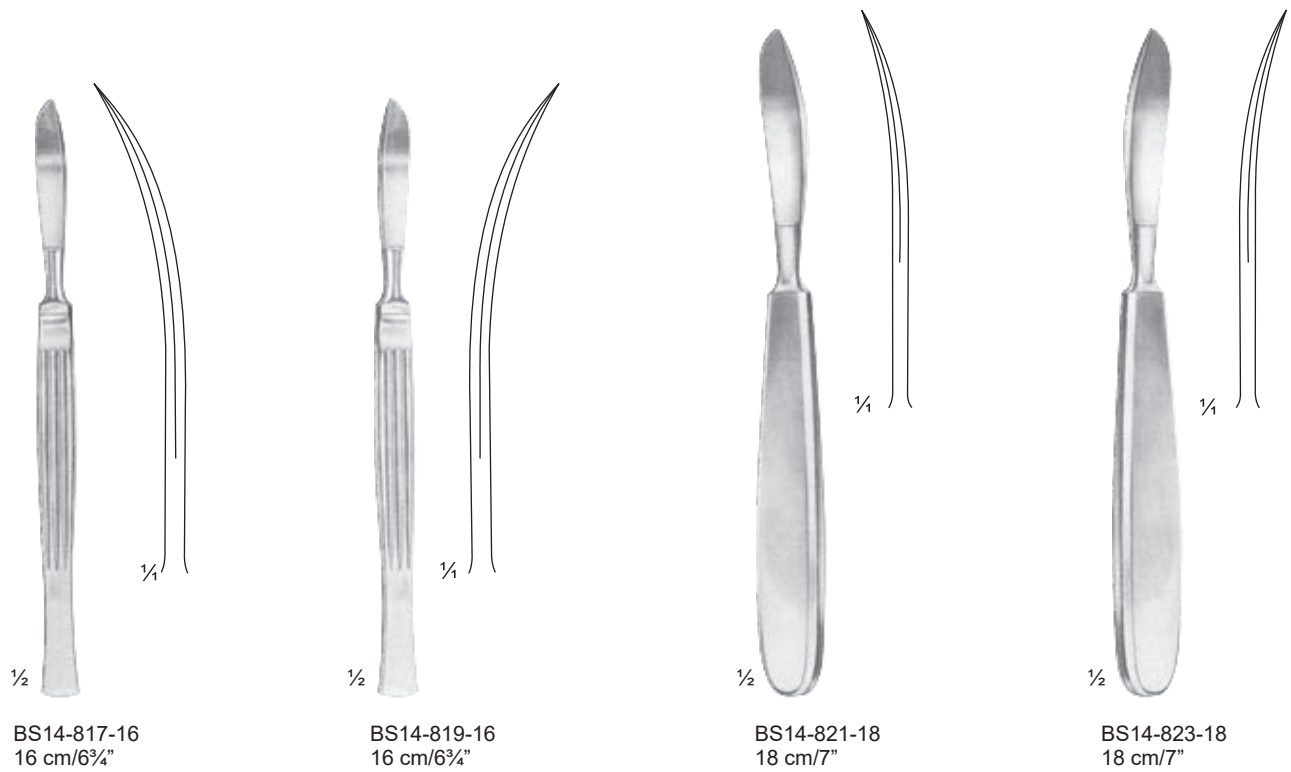
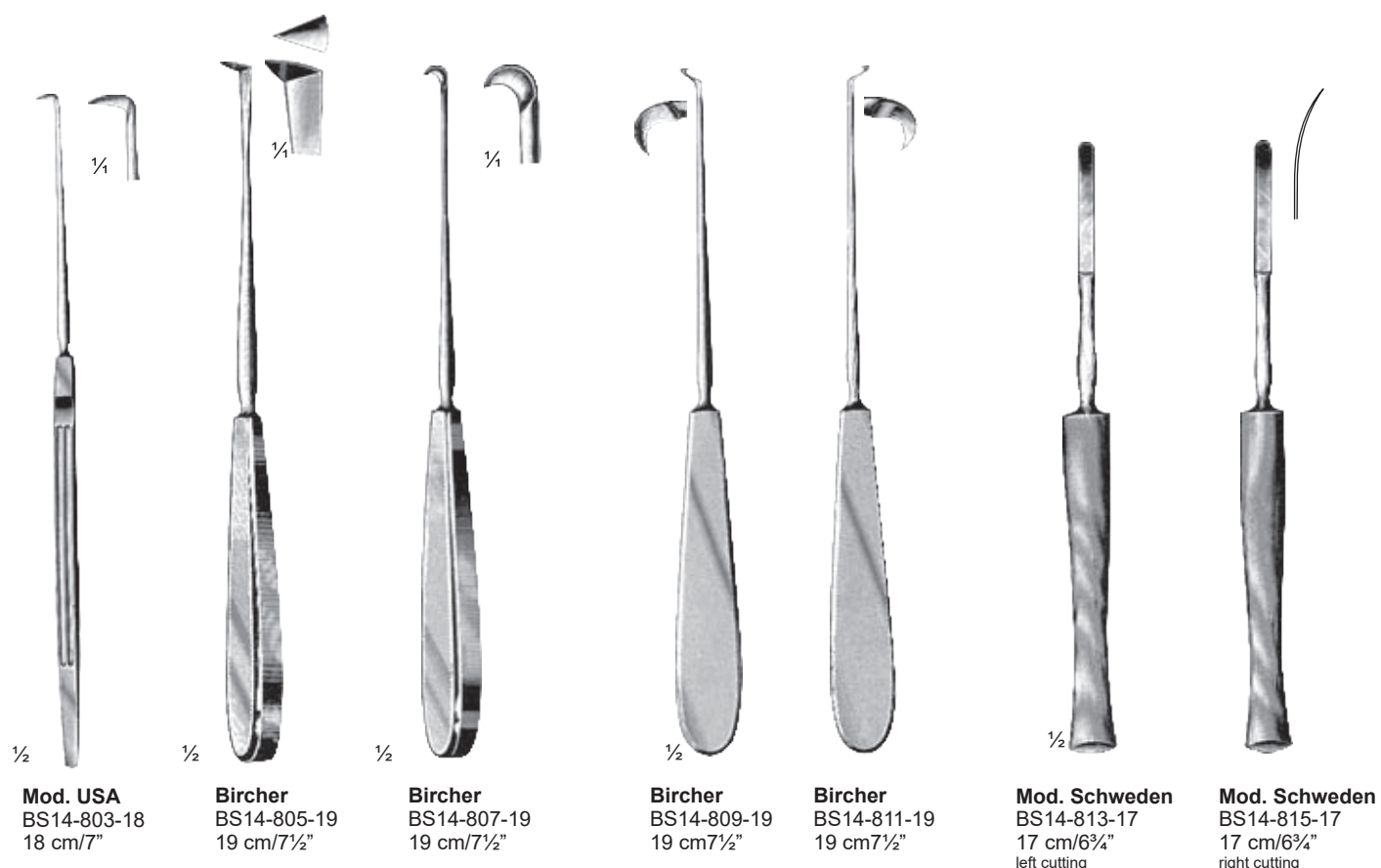

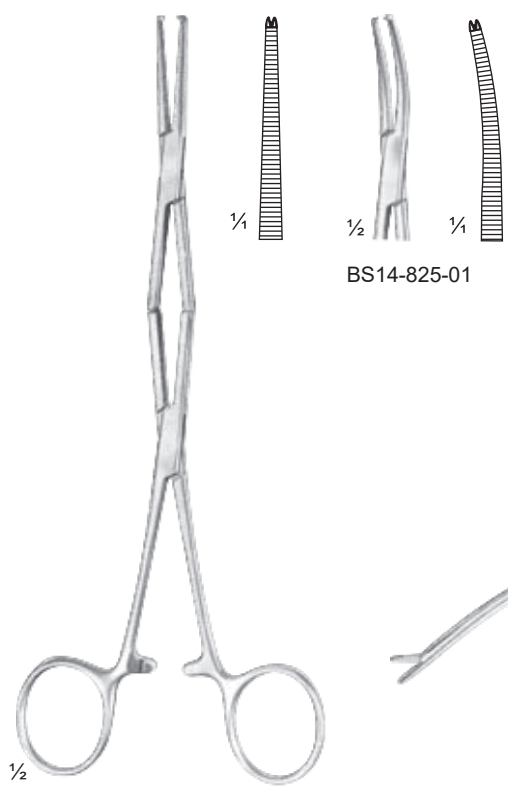

BS14-825-01

BS14-825-00
20.5 cm / 8"



BS14-827-11
11 cm / 9"

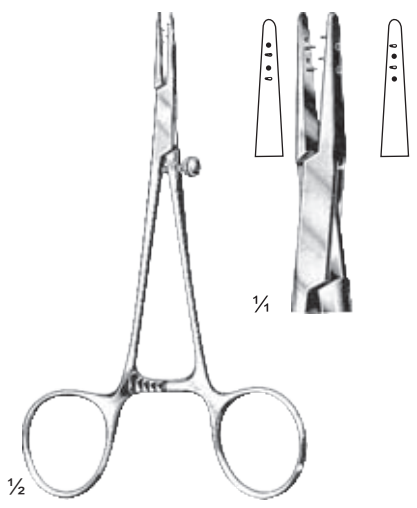

BS14-829-13
13 cm / 5"

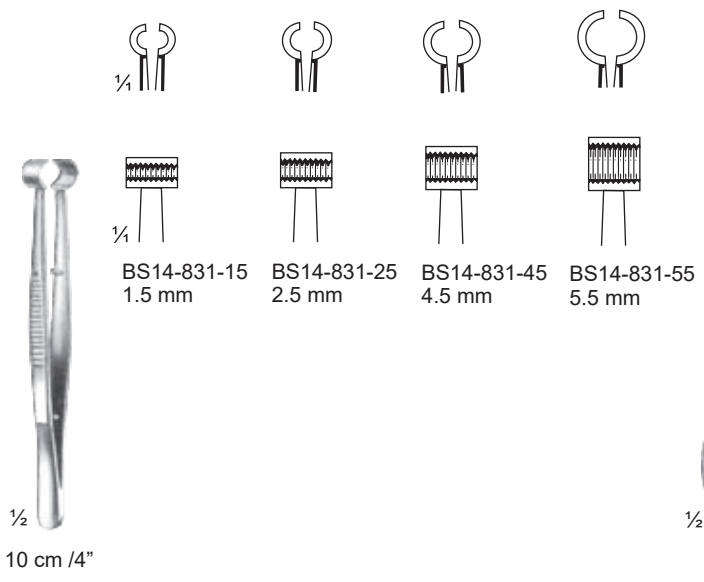

BS14-831-15 1.5 mm
BS14-831-25 2.5 mm
BS14-831-45 4.5 mm
BS14-831-55 5.5 mm

10 cm / 4"



Steinmann
BS14-833-16
16 cm / 6 1/4"



Brand
BS14-835-15 = 15 cm / 6"
BS14-835-19 = 19 cm / 7 1/2"
BS14-835-24 = 24 cm / 9 1/2"

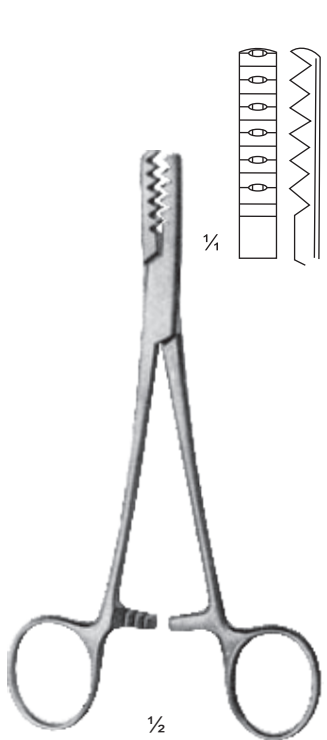

Martin
BS14-837-16
16 cm/6 1/4"



Martin
BS14-837-19
19.5 cm/7 3/4"

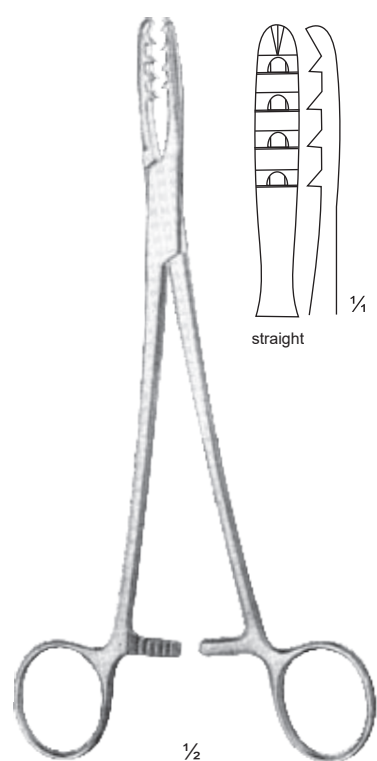

Bircher-Ganske
BS14-839-20
20 cm/8"

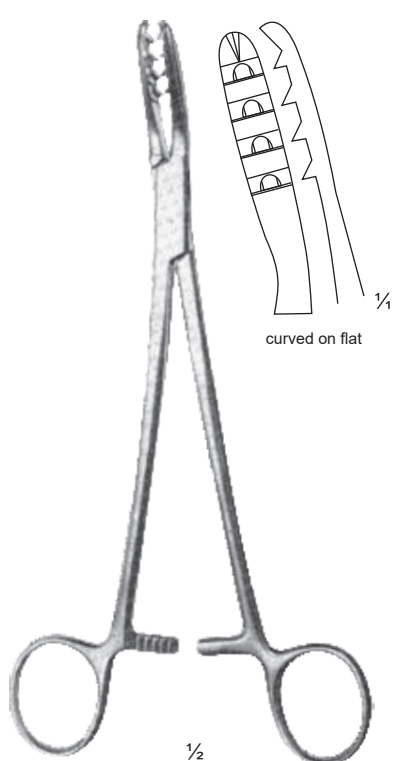

Bircher-Ganske
BS14-841-20
20 cm/8"

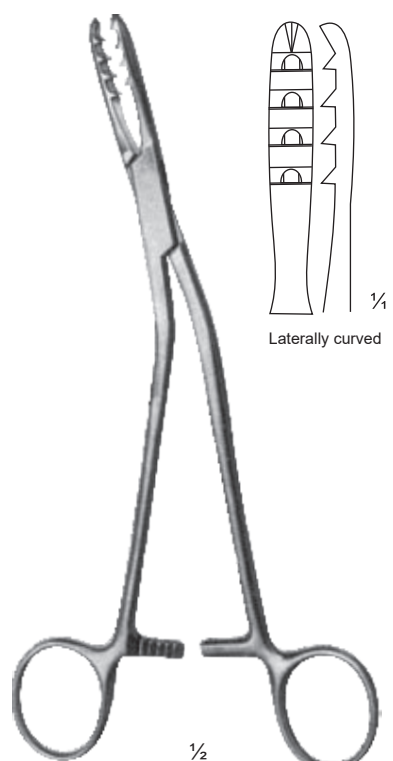

Bircher-Ganske
BS14-843-20
20 cm/8"

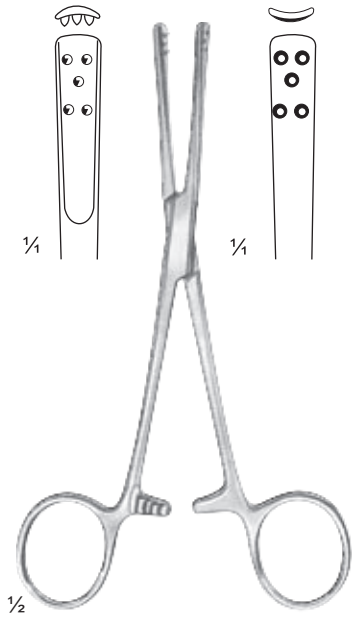

BS14-845-16
15.5 cm/5 1/4"



BS14-849-01

BS14-847-17



Mod. Martin
BS14-851-17
BS14-853-01

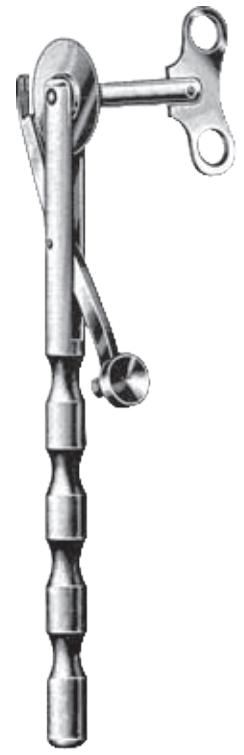

Smith
BS14-855-19
BS14-853-01

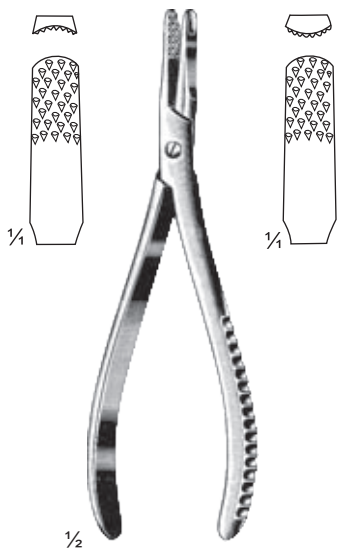

Radolf
BS14-857-13
13.5 cm/5 1/4"



Feldheim
BS14-859-10
10cm/4"

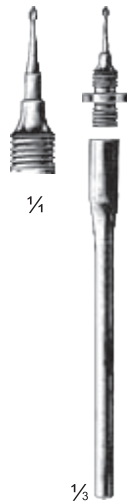

Simplex
BS14-861-19



Martin-Ideal
BS14-863-10



BS14-865-01



BS14-865-02



BS14-865-03

BS14-865-00 = Set

- BS14-851-17 - Finger Ring Saw, with protecting housing, complete
- BS14-855-19 - Finger Ring Saw, complete
- BS14-853-01 - Saw Blade only for No. BS14-851-17 and BS14-855-19
- BS14-849-01 - Saw Blade for No. BS14-855-17
- BS14-845-16 } - Forceps for tearing out toe and finger nails
- BS14-857-13 }

- BS14-859-10 - Tourniquet for fingers and toes, with woven, unbreakable metal strap
- BS14-861-19 - Finger Nail Drill, With 1 drill point
- ditto, with moveable hand support and chuck, drill points nested in the handle:
- BS14-863-10 - complete with 3 drill points of different sizes
- BS14-865-00 - Set of drill points only
- BS14-865-01 - 03 - Drill points single