

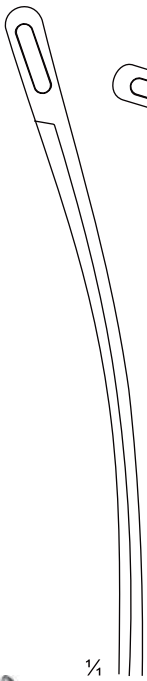

Kidney, Liver, Gall Urology





1
BS16-001-01
23cm/9"

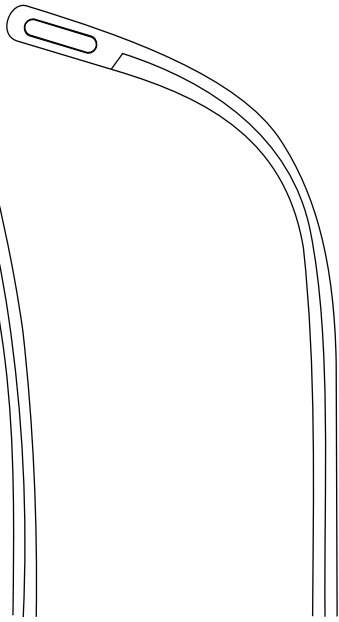

2
BS16-001-02
22cm/8¾"

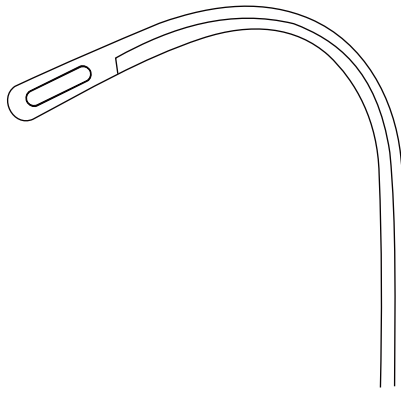

3
BS16-001-03
22cm/8¾"

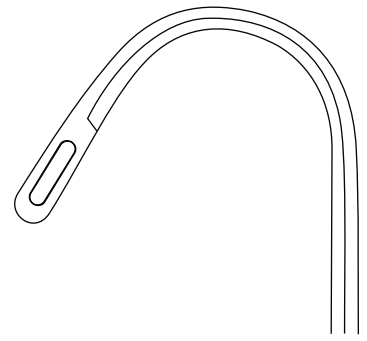

4
BS16-001-04
22cm/8¾"



Randall

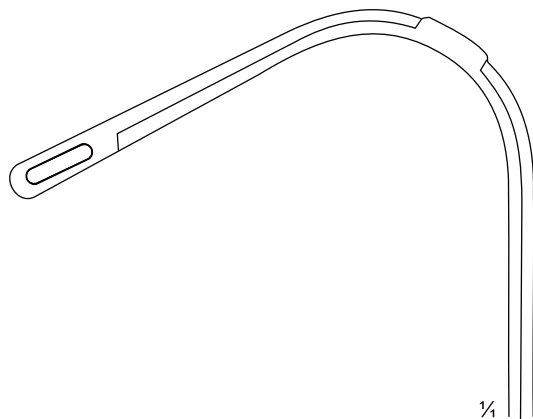

5
BS16-001-05
19cm/7"

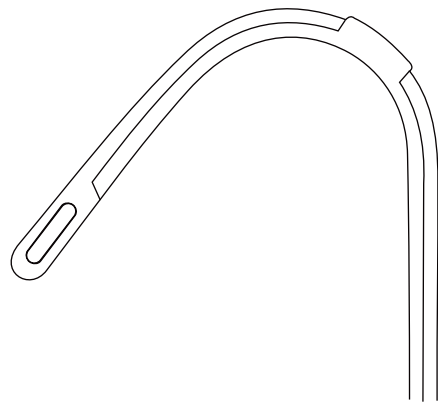

6
BS16-001-06
19cm/7"

Atrauma Renal Artery Clamps



¼

DeBakey
BS16-003-20
20cm/8"

Cooley
BS16-005-18
18.5cm/7¼"

Cooley
BS16-005-19
19.5cm/7¾"

Renal Artery Clamps- also used for subclavin and carotid artery



Kidney Pedicle Clamp Forceps

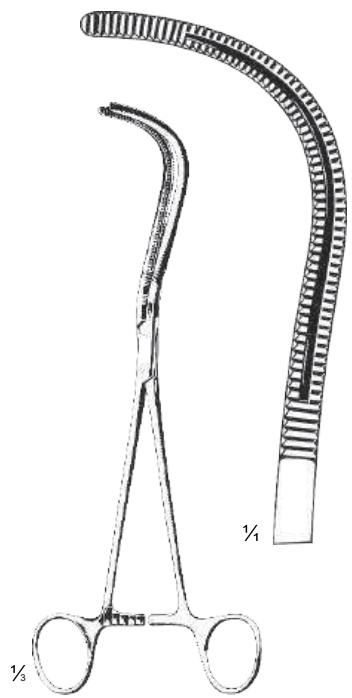

Stille
BS16-007-22
22cm/8 3/4"

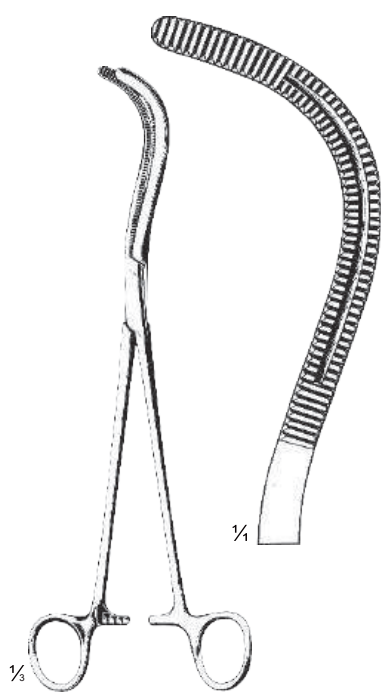

Stille
BS16-009-24
24cm/9 1/2"



Wertheim
BS16-011-25
25cm/10"



Herrick
BS16-013-23
23cm/9"



Pean



BS16-015-20
20cm/8"



BS16-015-22
22cm/8 3/4"



BS16-015-24
24cm/9 1/2"

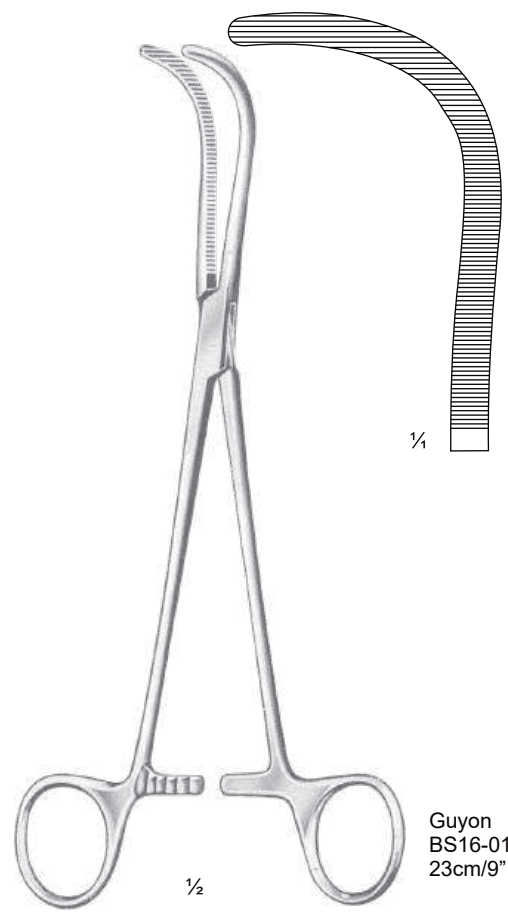

Guyon
BS16-017-23
23cm/9"

Gall Stone Forceps

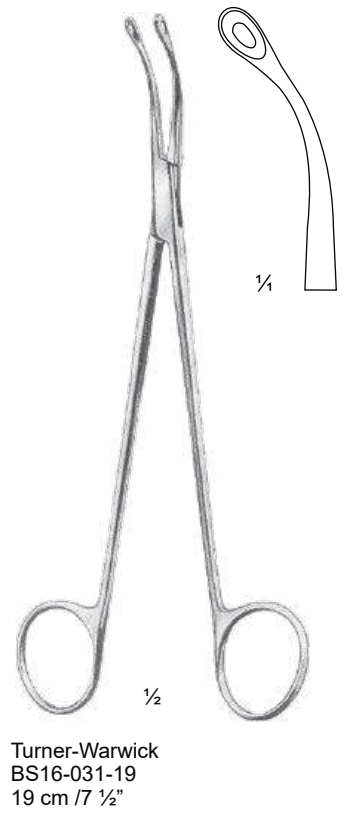
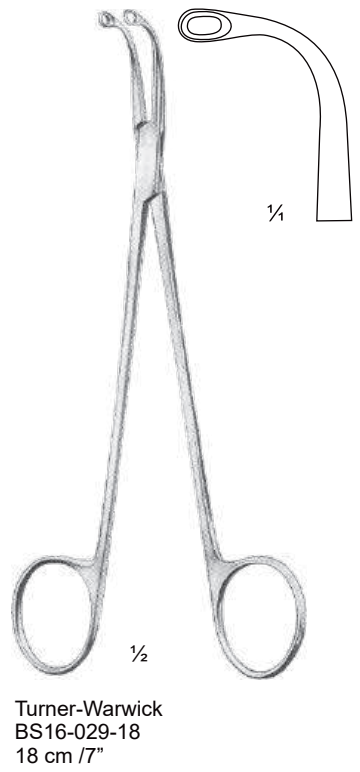
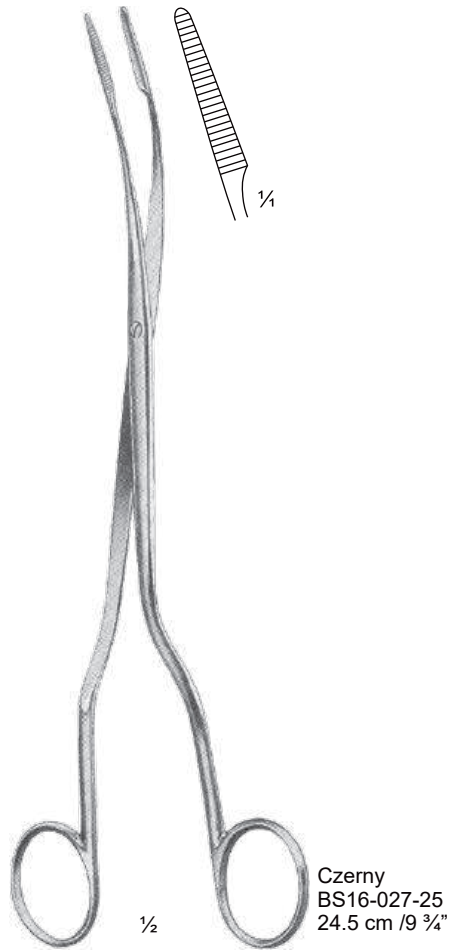



Mixer
BS16-033-22
22 cm / 8 3/4"

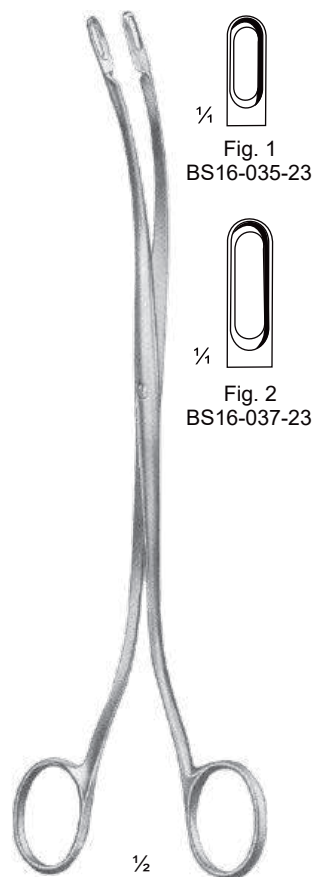

Desjardins
23 cm / 9"

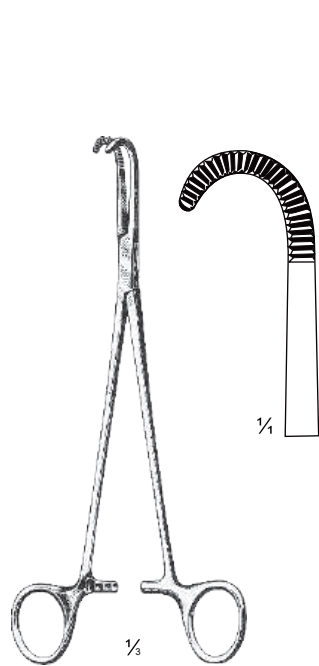

Desjardins
BS16-039-21
21cm/8 1/4"

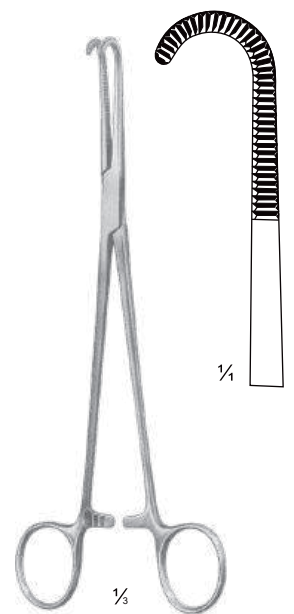

Nissen
BS16-041-22
22.5cm/9"

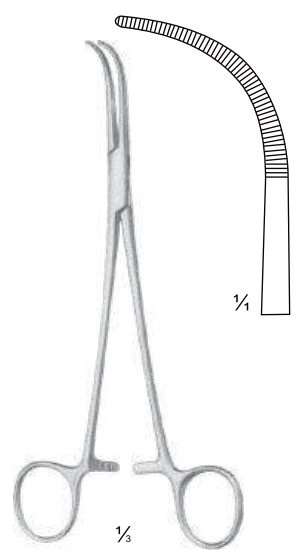

Green
BS16-043-20
20cm/8"



Gray

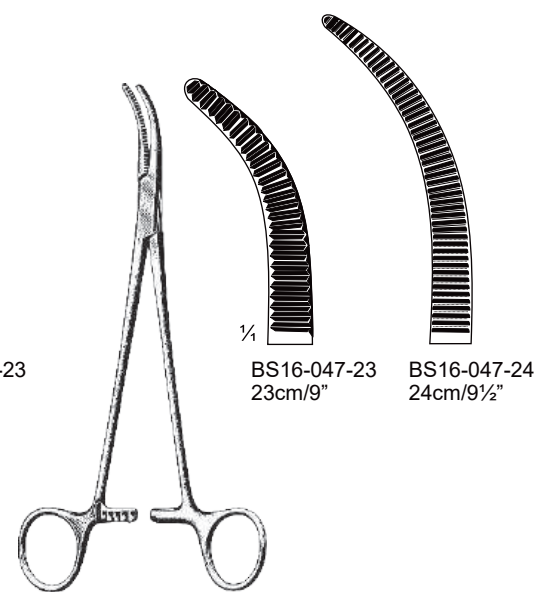

Moynihan

BS16-045-22
22cm/8 3/4"

BS16-045-23
23cm/9"

BS16-047-23
23cm/9"

BS16-047-24
24cm/9 1/2"



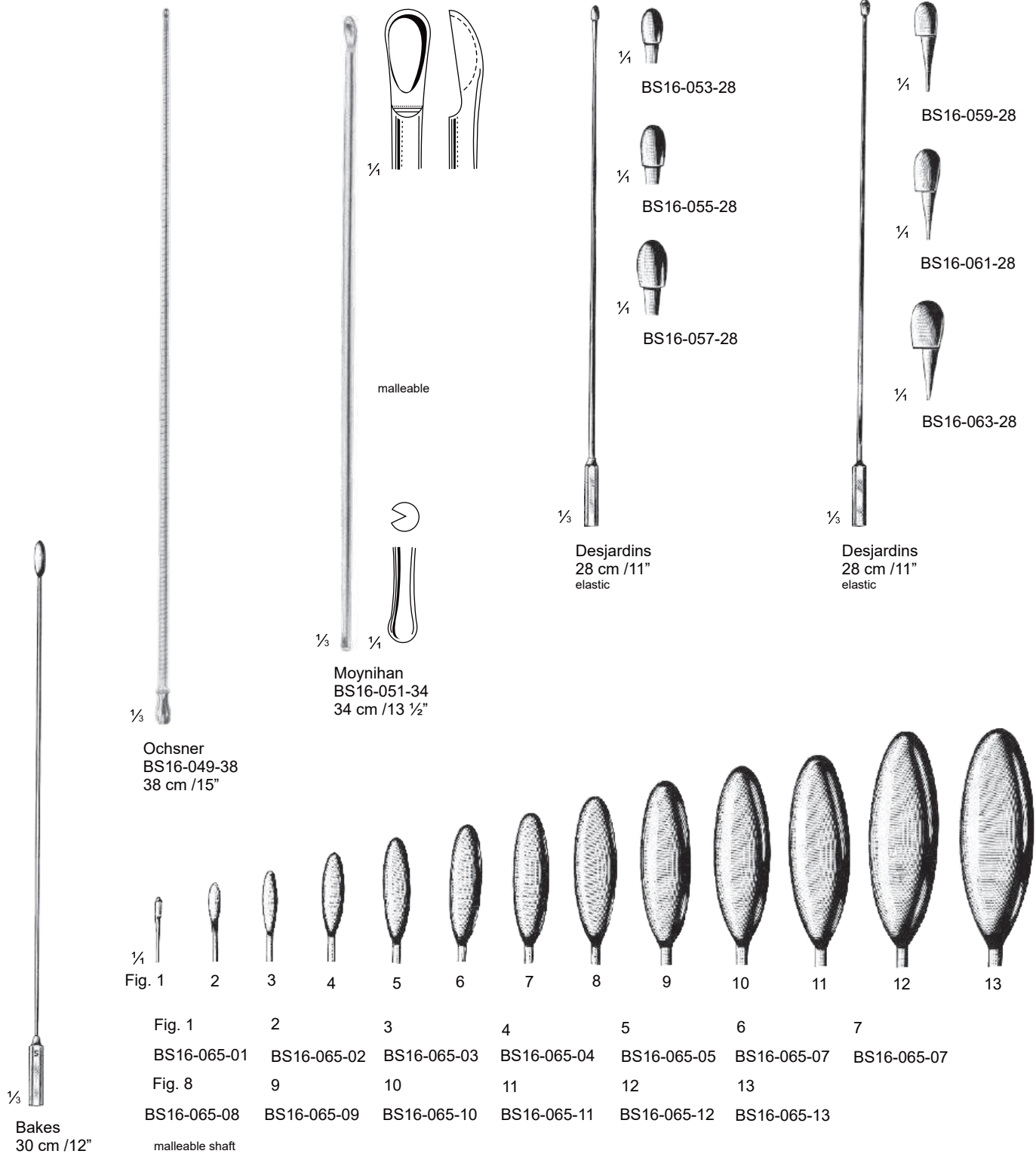

BS16-049-38 - Gall Duct Probe, with stilette, malleable
 BS16-053-28 - BS16-057-28 - with eccentric olives
 BS16-059-28 - BS16-063-28 - Gall Stone Probes, elastic
 BS16-065-01 - BS16-065-13 - Gall Duct Dilators, Copper shaft, malleable

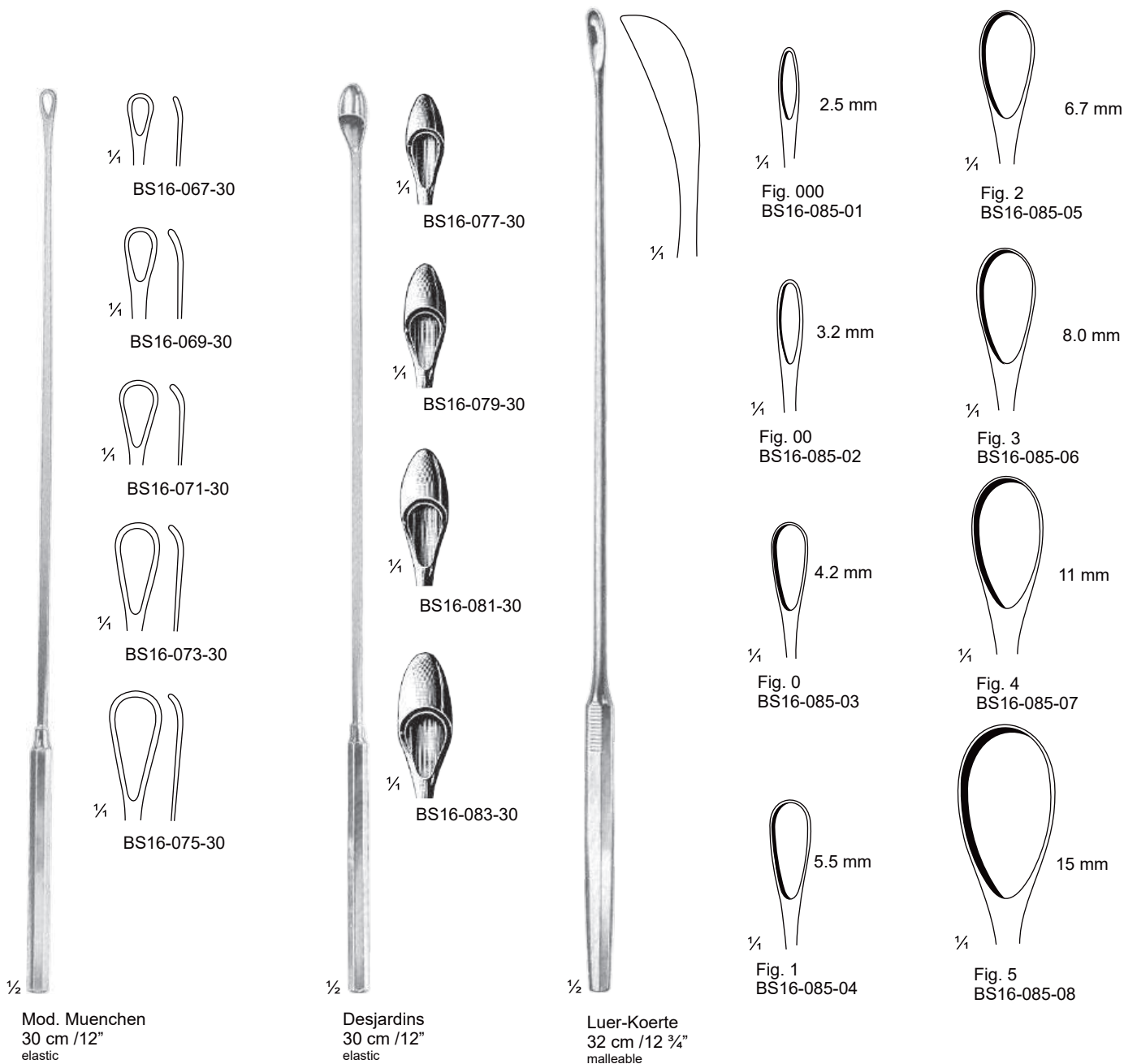



1/4 Fergusson BS16-087-21 21.5 cm / 8 1/2"
 1/4 Fergusson BS16-087-22 22 cm / 8 3/4"
 1/4 Fergusson BS16-087-23 23.5 cm / 9 1/4"

1/2 Mayo BS16-089-27 28 cm / 11"

1/2 BS16-091-34 34 cm / 12 1/2"

1/2 Moore BS16-093-28 28 cm / 11"

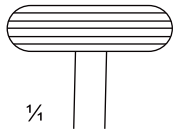

1/4



1/2

BS16-095-16
16 cm / 6 1/4"
Spermatic Cord Hook, blunt

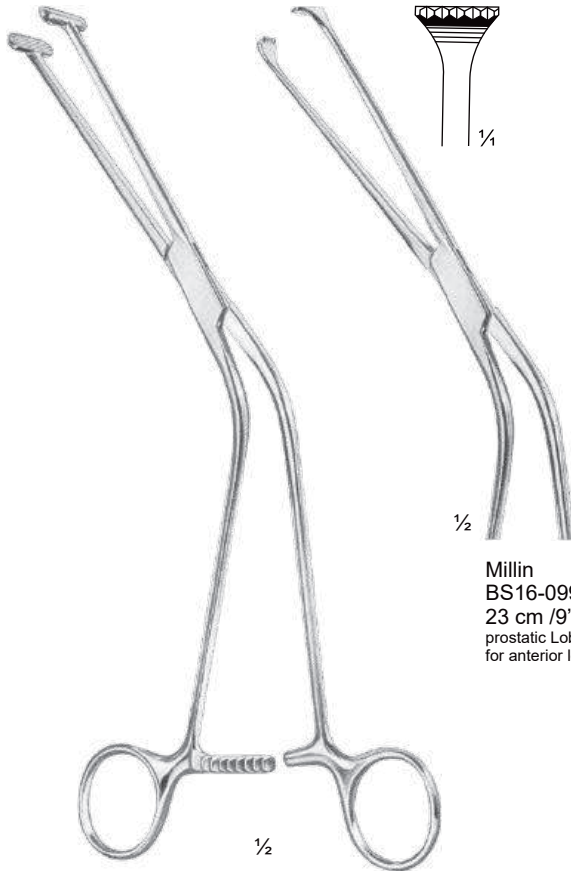

1/2

Millin
BS16-099-23
23 cm / 9"
prostatic Lobe Holding Forceps,
for anterior lobes, 9:9 teeth

Millin
BS16-097-23
23 cm / 9"
Capsule Forceps,
for retropubic prostatectomy

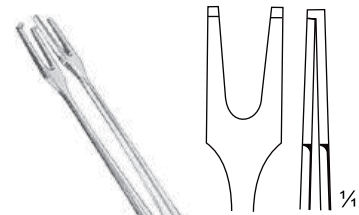

1/4



1/2

Millin
BS16-101-24
24 cm / 9 1/2"
Ligature Carrying Forceps

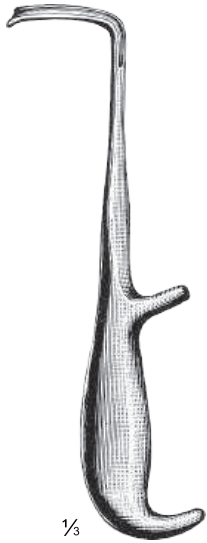

Young
BS16-103-21
21 cm / 8 1/4"



Young
BS16-105-22
22 cm / 8 3/4"



Young
BS16-107-21
21 cm / 8 1/4"
for bulb

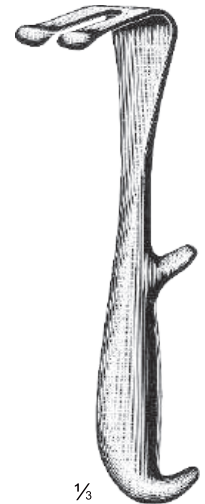

Young
BS16-109-22
22 cm / 8 3/4"

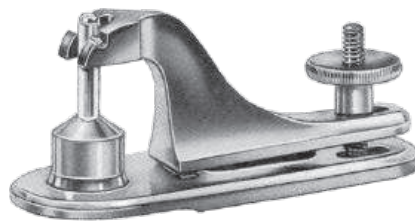

Circumcision Instrument
BS16-111-08 - BS16-111-32

- BS16-111-08 - 8 mm ø, baby size
- BS16-111-11 - 11 mm ø, child size
- BS16-111-13 - 13 mm ø, child size
- BS16-111-16 - 16 mm ø, adolescent size
- BS16-111-21 - 21 mm ø, adolescent size
- BS16-111-26 - 26 mm ø, men's size
- BS16-111-32 - 32 mm ø, men's size



Dittel 6-10 mm 18-30 Charriere
 Dittel Charriere (French) No. 8-30
 Van Buren Charriere (French) No. 8-36
 Guyon Charriere No. 10-30
 Guyon Charriere No. 10-30
 Filiform 31-610-12

Set	BS16-115-00	BS16-117-00	BS16-119-00	BS16-121-00
single	BS16-113-00	BS16-115-08 - 31-680-30	BS16-117-08 - 31-699-36	BS16-119-10 - BS16-119-30 BS16-121-00 - BS16-121-30
		Scale mm Ø	I	II
		2 [∞] Ø	8	
		3	9	
		3 [∞] +	10	20
		3 [∞] Ø	11	22
		4	12	24
		4	13	26
		4	14	28
		5	15	30
		5	16	32
		5	17	34
		6	18	36
		6	19	38
		6	20	40
		7	21	42
		7	22	44
		7	23	46
		8	24	48
		8	25	50
		8	26	52
		9	27	54
		9	28	56
		9	29	58
		10	30	60
		10	32	
		10	34	
		10	36	
			Dittel	Van Buren curved
			BS16-115-08	BS16-117-08
			BS16-115-09	
			BS16-115-10	BS16-117-10
			BS16-115-11	
			BS16-115-12	BS16-117-12
			BS16-115-13	
			BS16-115-14	BS16-117-14
			BS16-115-15	
			BS16-115-16	BS16-117-16
			BS16-115-17	
			BS16-115-18	BS16-117-18
			BS16-115-19	
			BS16-115-20	BS16-117-20
			BS16-115-21	
			BS16-115-22	BS16-117-22
			BS16-115-23	
			BS16-115-24	BS16-117-24
			BS16-115-25	
			BS16-115-26	BS16-117-26
			BS16-115-27	
			BS16-115-28	BS16-117-28
			BS16-115-29	
			BS16-115-30	BS16-117-30
				BS16-117-32
				BS16-117-34
				BS16-117-36
			Guyon without int. thread	Guyon with int. thread
			BS16-119-10	BS16-121-10
			BS16-119-11	BS16-121-11
			BS16-119-12	BS16-121-12
			BS16-119-13	BS16-121-13
			BS16-119-14	BS16-121-14
			BS16-119-15	BS16-121-15
			BS16-119-16	BS16-121-16
			BS16-119-17	BS16-121-17
			BS16-119-18	BS16-121-18
			BS16-119-19	BS16-121-19
			BS16-119-20	BS16-121-20
			BS16-119-21	BS16-121-21
			BS16-119-22	BS16-121-22
			BS16-119-23	BS16-121-23
			BS16-119-24	BS16-121-24
			BS16-119-25	BS16-121-25
			BS16-119-26	BS16-121-26
			BS16-119-27	BS16-121-27
			BS16-119-28	BS16-121-28
			BS16-119-29	BS16-121-29
			BS16-119-30	BS16-121-30

Metal Catheters

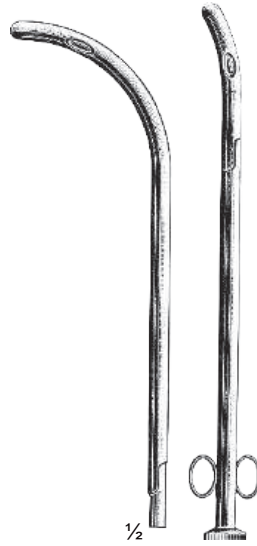

BS16-123-00
male and female

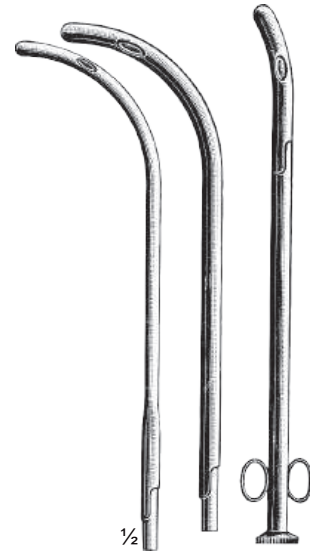

BS16-125-00
male, female and
for children

Table of measurements

Scale mm ø	Charriere (French)
2	6
2 1/3	7
2 2/3	8
3	9
3 1/3	10
3 2/3	11
4	12
4 1/3	13
4 2/3	14
5	15
5 1/3	16
5 2/3	17
6	18
6 1/3	19
6 2/3	20
7	21
7 1/3	22
7 2/3	23
8	24

BS16-127-06	BS16-129-06
BS16-127-07	BS16-129-07
BS16-127-08	BS16-129-08
BS16-127-09	BS16-129-09
BS16-127-10	BS16-129-10
BS16-127-12	BS16-129-12
BS16-127-13	BS16-129-13
BS16-127-14	BS16-129-14
BS16-127-15	BS16-129-15
BS16-127-16	BS16-129-16
BS16-127-17	BS16-129-17
BS16-127-18	BS16-129-18
BS16-127-19	BS16-129-19
BS16-127-20	BS16-129-20
BS16-127-21	BS16-129-21
BS16-127-22	BS16-129-22
BS16-127-23	BS16-129-23
BS16-127-24	BS16-129-24



BS16-127-06 - BS16-127-24
Charriere (French) No. 6-24
27 cm / 10 1/2"
Male Catheters



BS16-129-06 - BS16-129-24
Charriere (French) No. 6-24
15 cm / 6"
Female Catheters Combined,
for pocket sets

Foreign Body Forceps, Meatotome
Secretion Scoops, penis Seizing Forceps, Meatus Clamps

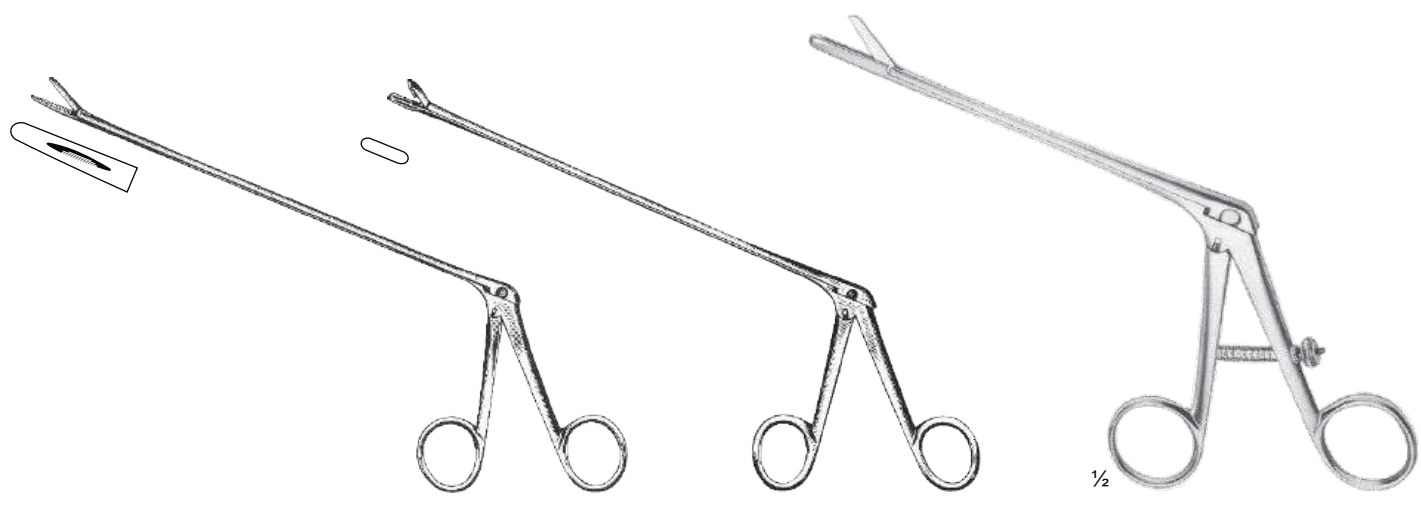

Lengths of shanks

Mathieu
BS16-131-20 = 20 cm/8"
BS16-131-28 = 28 cm/11"
Urethral Foreign Body Forceps, serrated jaws

Mathieu
BS16-133-20 = 20 cm/8"
BS16-133-28 = 28 cm/11"
Urethral Foreign Body Forceps, serrated jaws sharp, punch jaws

Sachse
BS16-135-12
Meatotome

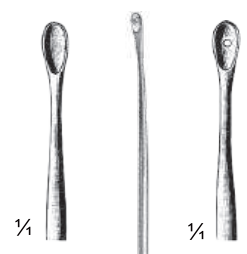

¼

¼

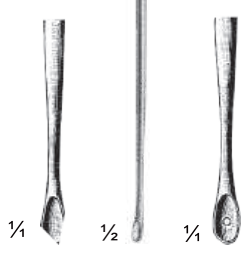

¼

½

¼

Guttman
BS16-137-26
Secretion Scoops flexible, may be held in the open flame, without holes
BS16-139-26
with holes
26.5 cm / 10 ½"



½

Jusbasic
BS16-141-19
19 cm / 7 ½"
Penis Seizing Forceps



½

Strauss
BS16-143-11
Meatus Clamp, rubber covered



Bladder Retractors

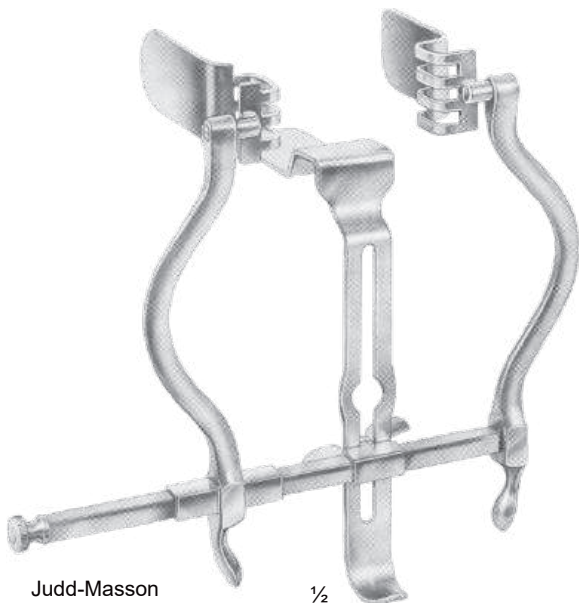

Judd-Masson
BS16-145-00

1/2

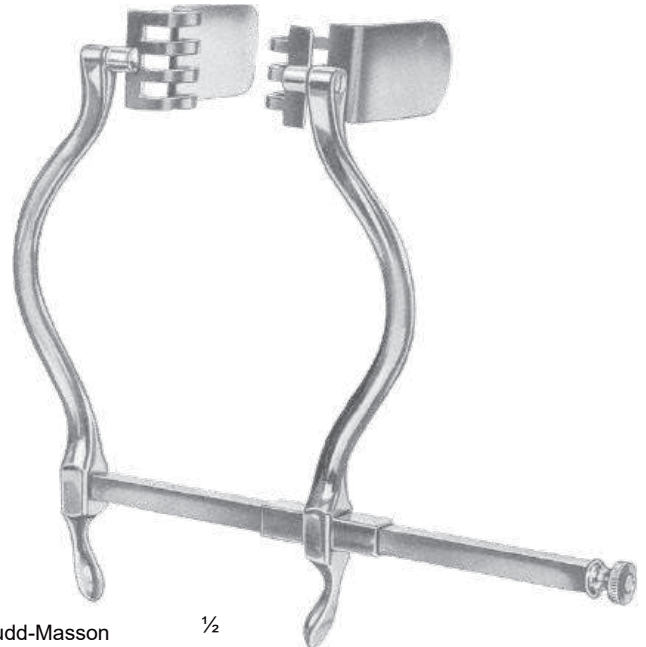

Judd-Masson
BS16-147-00

1/2



Thomson-Walker
BS16-149-00

1/2

1/2



1/2

Legueu
BS16-151-00

- BS16-147-00 - for supra pubic prostatectomy, with 2 swivel blades
- BS16-149-00 - self-retaining, with 4 detachable blades, center spatula and retractor
- BS16-151-00 - with 2 detachable blades and center spatula



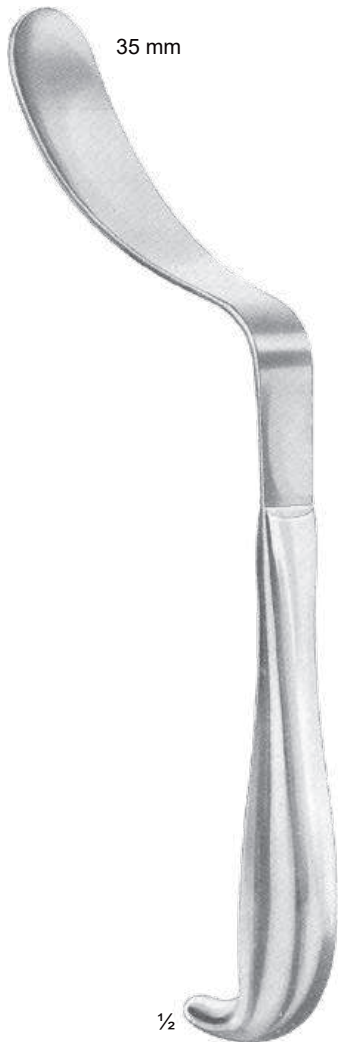

Legueu
BS16-153-27
27 cm / 10 1/2"



Kocher
BS16-155-26
26 cm / 10 1/4"



Kocher
BS16-157-26
26 cm / 10 1/4"

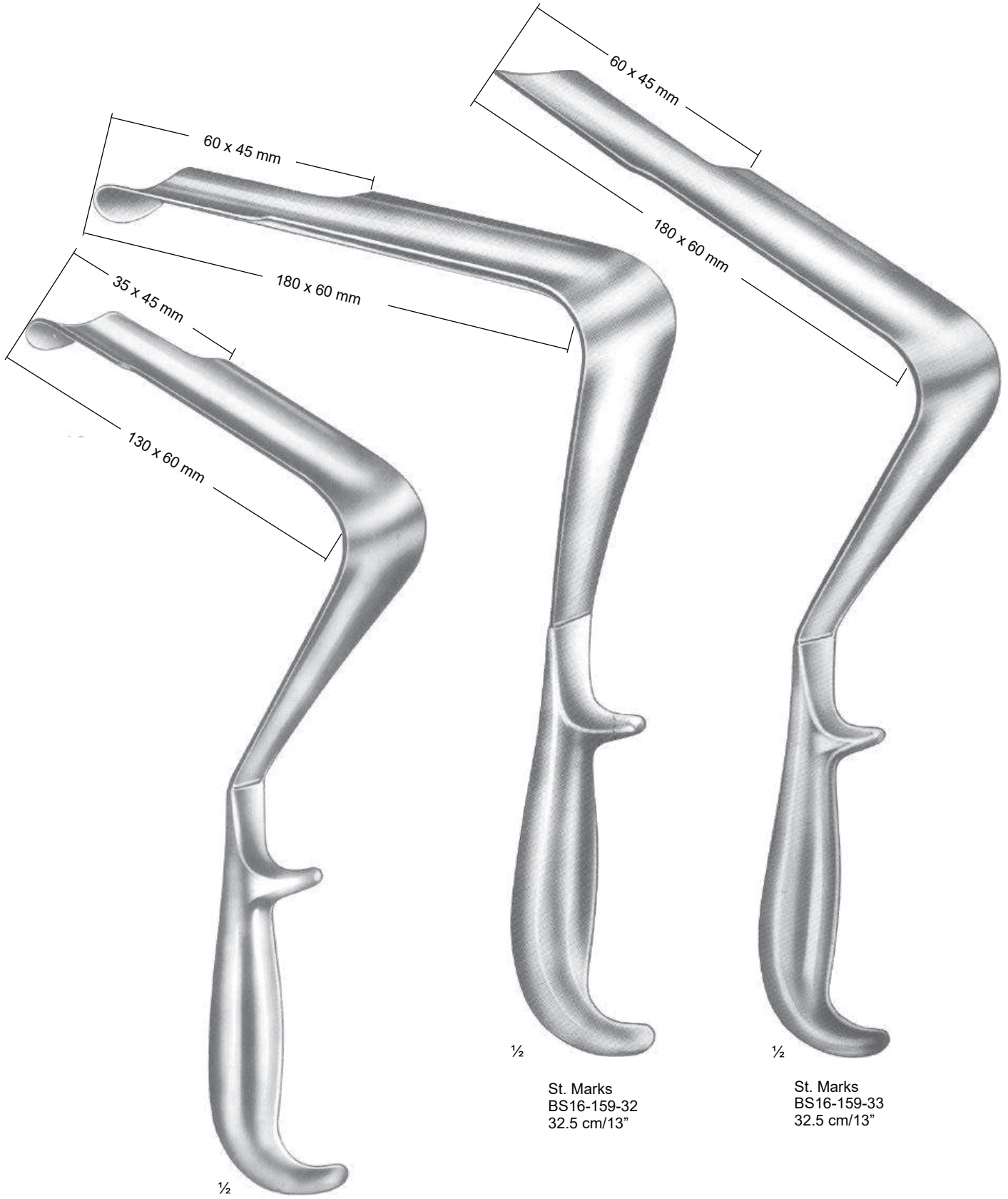

1/2
St. Marks
BS16-159-29
29 cm/11 1/2"

1/2
St. Marks
BS16-159-32
32.5 cm/13"

1/2
St. Marks
BS16-159-33
32.5 cm/13"





Millin
BS16-161-00
Meatus Clamp
(Bladder Neck Spreader)

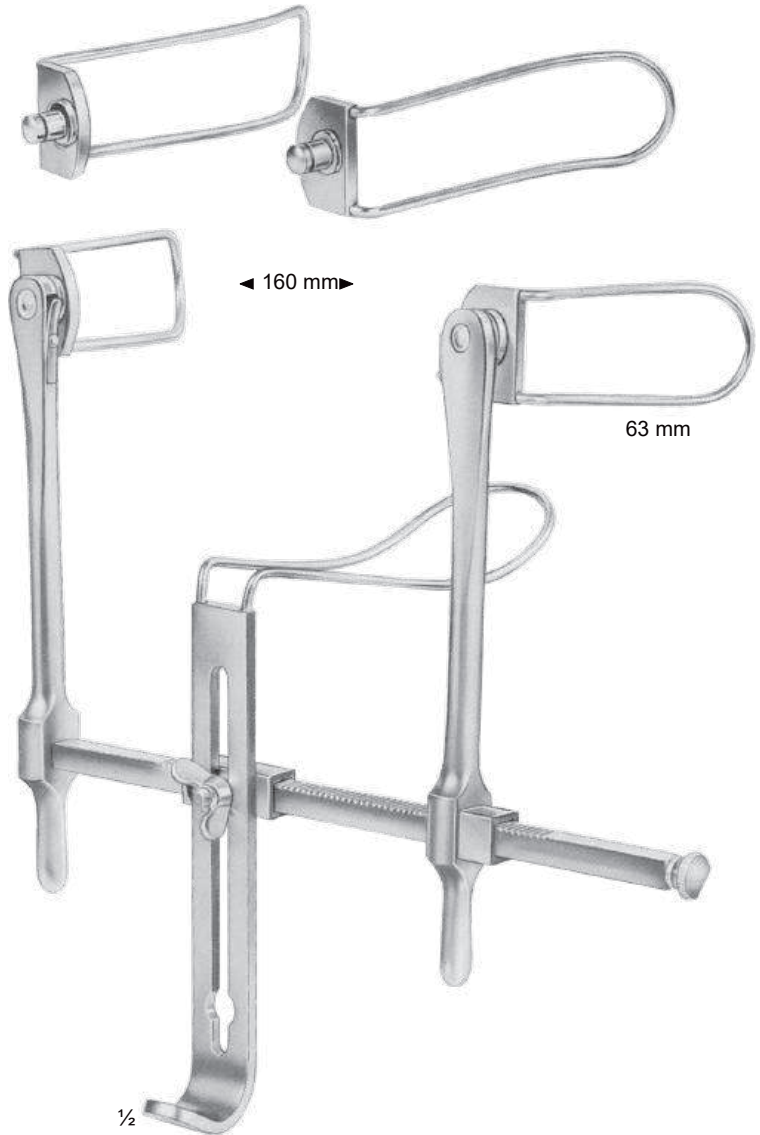

Gosset
BS16-163-00
Bladder Retractor